



US00D423314S

# United States Patent [19] Robson

[11] Patent Number: Des. 423,314

[45] Date of Patent: \*\* Apr. 25, 2000

[54] JIG SAW

[75] Inventor: Nigel Robson, Gilesgate, United Kingdom

[73] Assignee: Black & Decker Inc., Newark, Del.

[\*\*] Term: 14 Years

[21] Appl. No.: 29/090,335

[22] Filed: Jul. 7, 1998

### [30] Foreign Application Priority Data

Jan. 13, 1998 [GB] United Kingdom ..... 2071615

[51] LOC (6) Cl. .... 08-02

[52] U.S. Cl. .... D8/64

[58] Field of Search ..... D8/64; 30/392, 30/393, 394; 83/699.21

### [56] References Cited

#### U.S. PATENT DOCUMENTS

- D. 329,166 9/1992 Doggett .
- D. 333,767 3/1993 Sasaki et al. .
- D. 339,276 9/1993 Matsuoka et al. .... D8/64
- D. 340,395 10/1993 Tanaka .
- D. 362,783 10/1995 Cruz .
- D. 367,400 2/1996 Viemeister et al. .

- D. 380,132 6/1997 Matsunaga et al. .
- 3,973,179 8/1976 Weber et al. .
- 5,819,421 10/1998 Giacometti et al. .... 30/392

### OTHER PUBLICATIONS

Best Catalog 1989/90 showing a Sunbeam® 6-Speed Mixmaster Hand Mixer and a Sunbeam® 4-Speed Mixmaster Hand Mixer.

Primary Examiner—Antoine Duval Davis  
Attorney, Agent, or Firm—Bruce S. Shapiro; Dennis A. Dearing; John D. Del Ponti

### [57] CLAIM

The ornamental design for a jig saw, as shown and described.

### DESCRIPTION

FIG. 1 is a front perspective view of a jig saw showing my new design.  
 FIG. 2 is a left side elevational view thereof.  
 FIG. 3 is a right side elevational view thereof.  
 FIG. 4 is a top plan view thereof.  
 FIG. 5 is a bottom plan view thereof.  
 FIG. 6 is a front elevational view thereof; and,  
 FIG. 7 is a rear elevational view thereof.

1 Claim, 3 Drawing Sheets

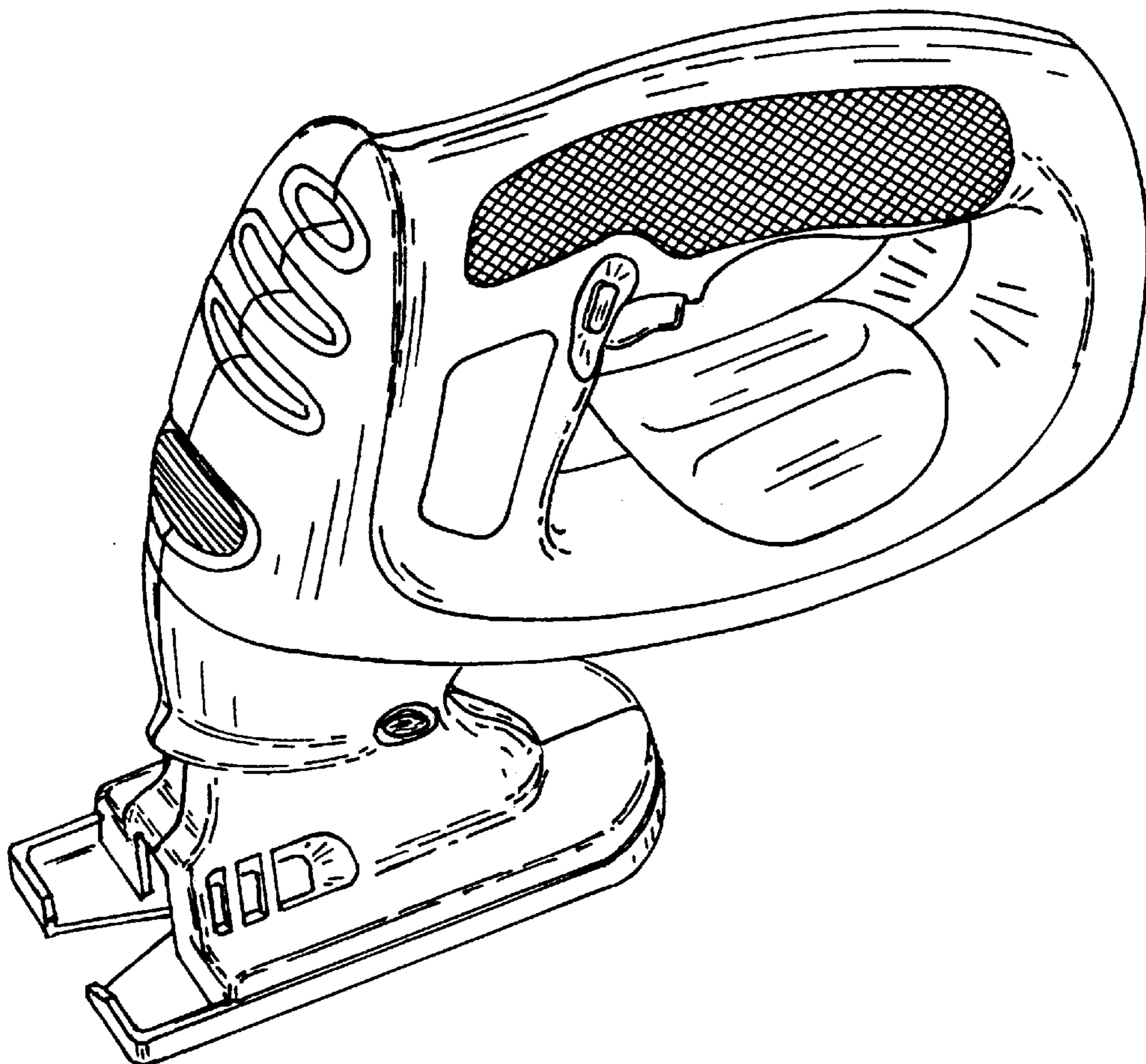

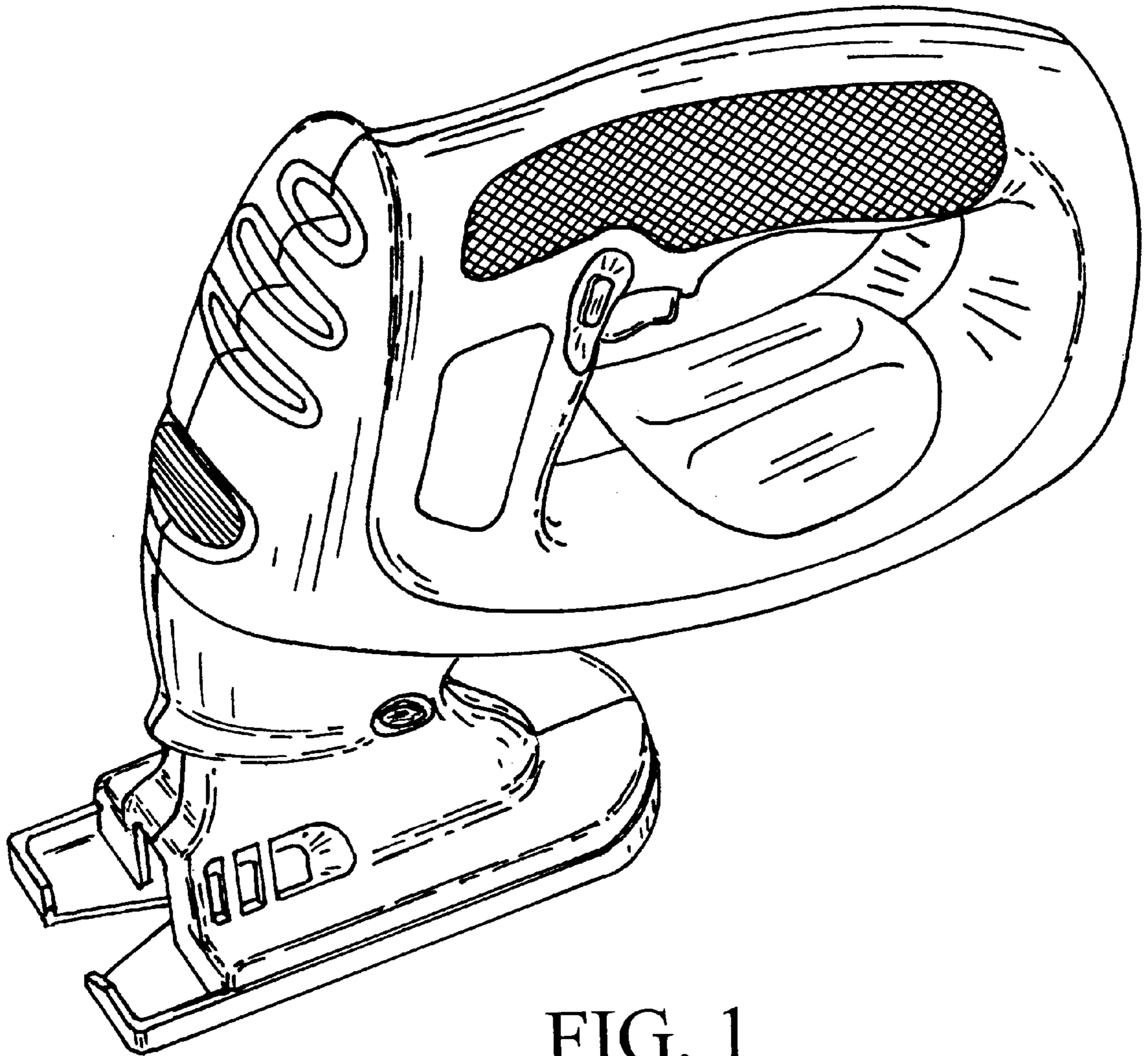

FIG. 1

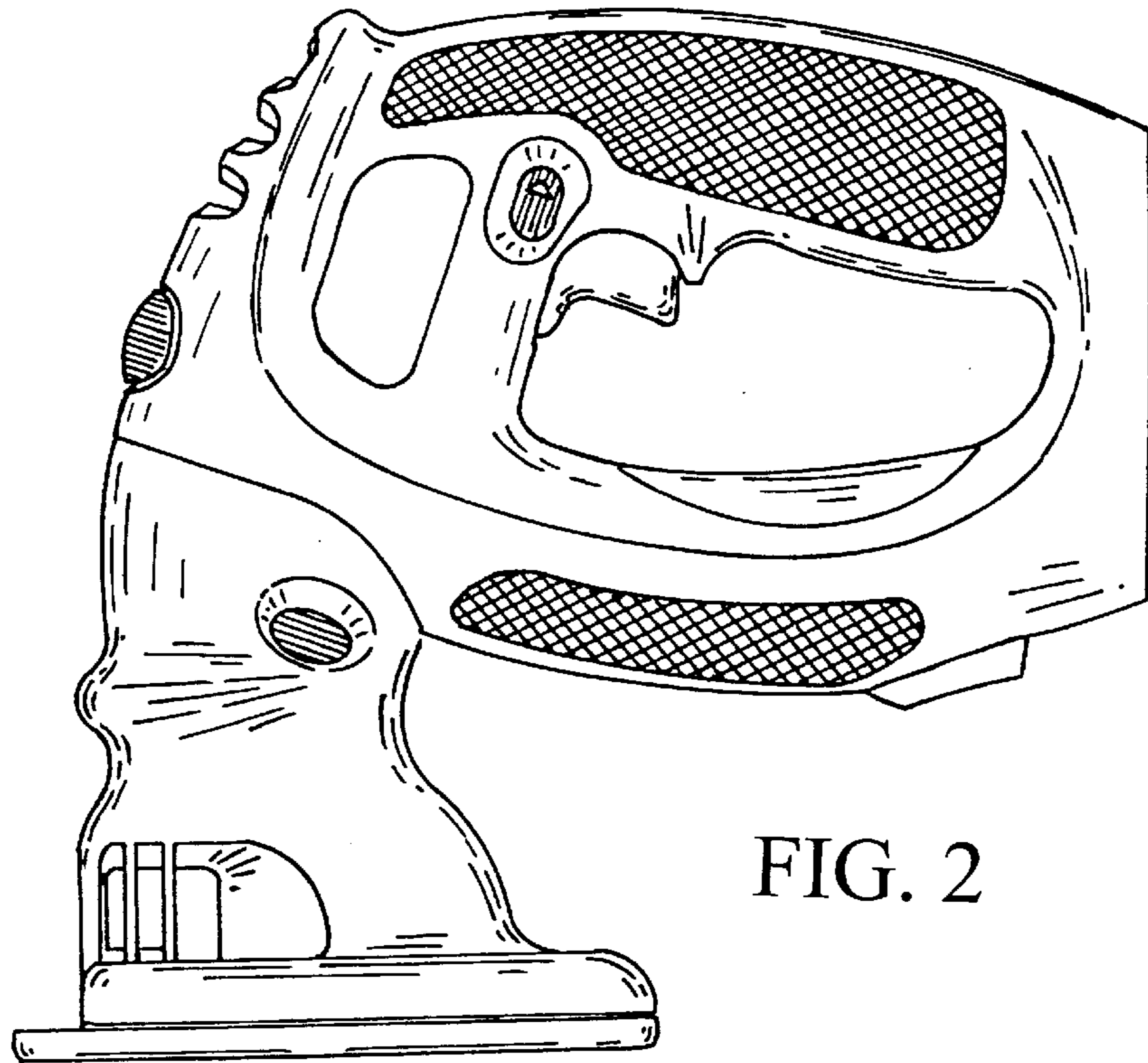

FIG. 2

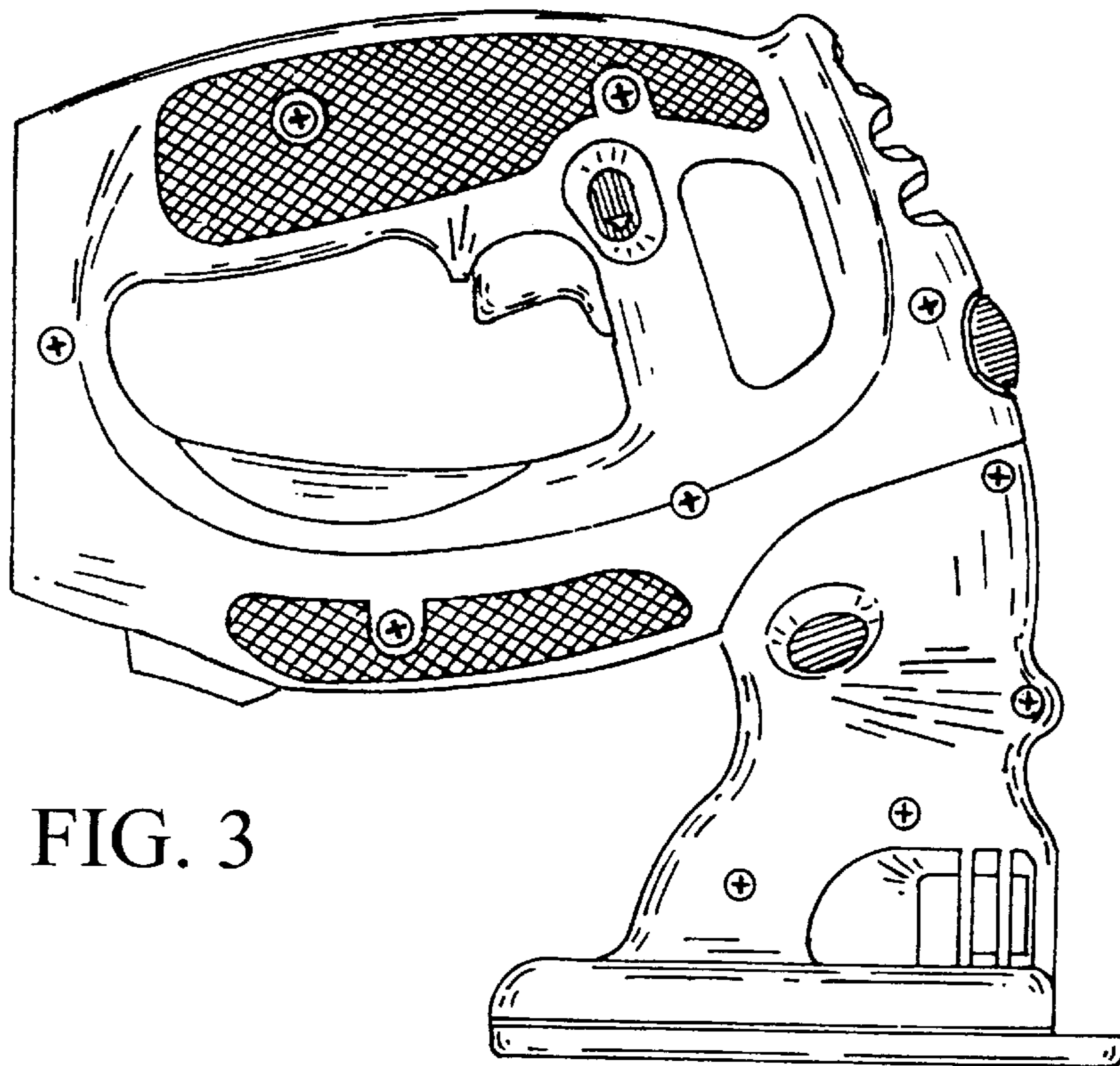

FIG. 3

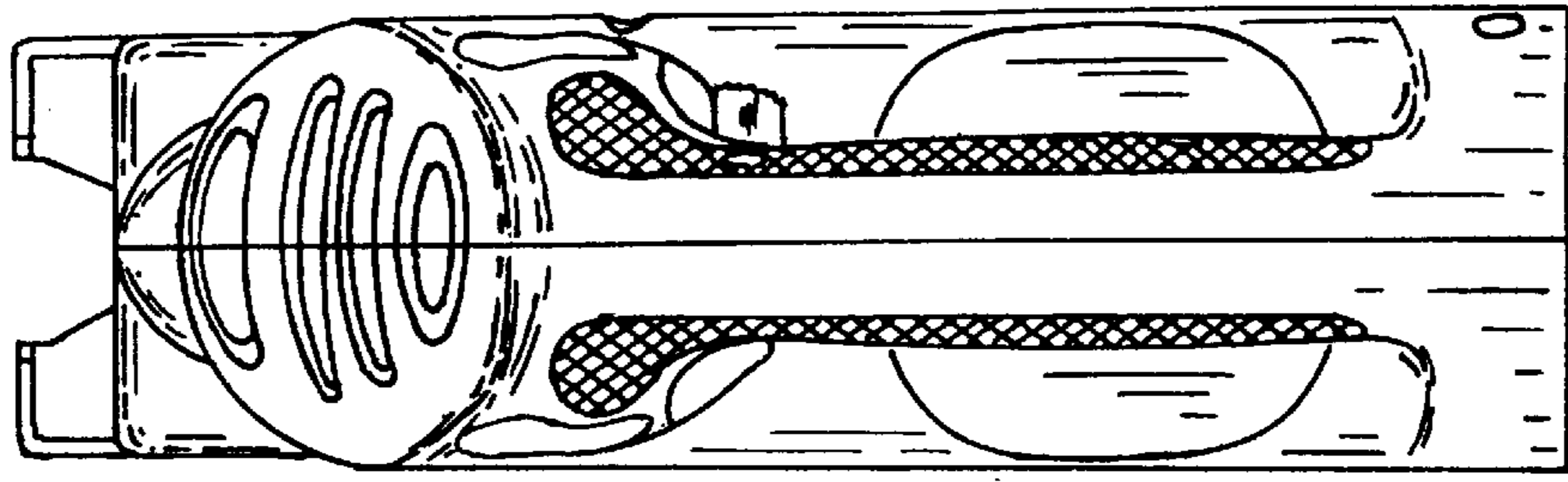

FIG. 4

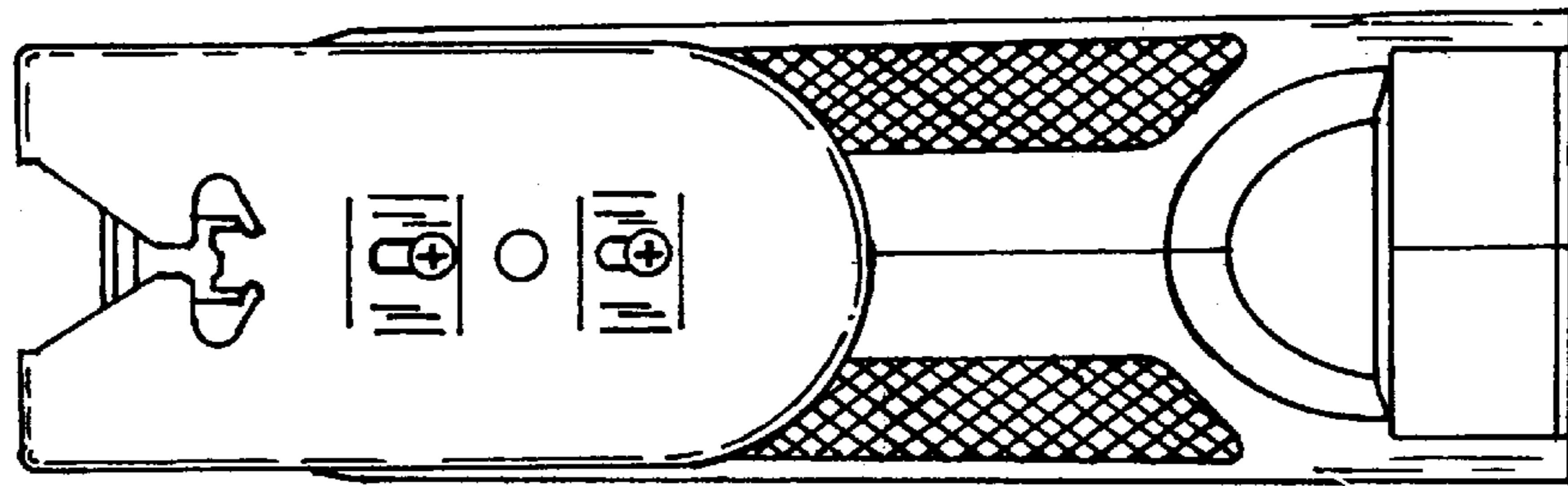

FIG. 5

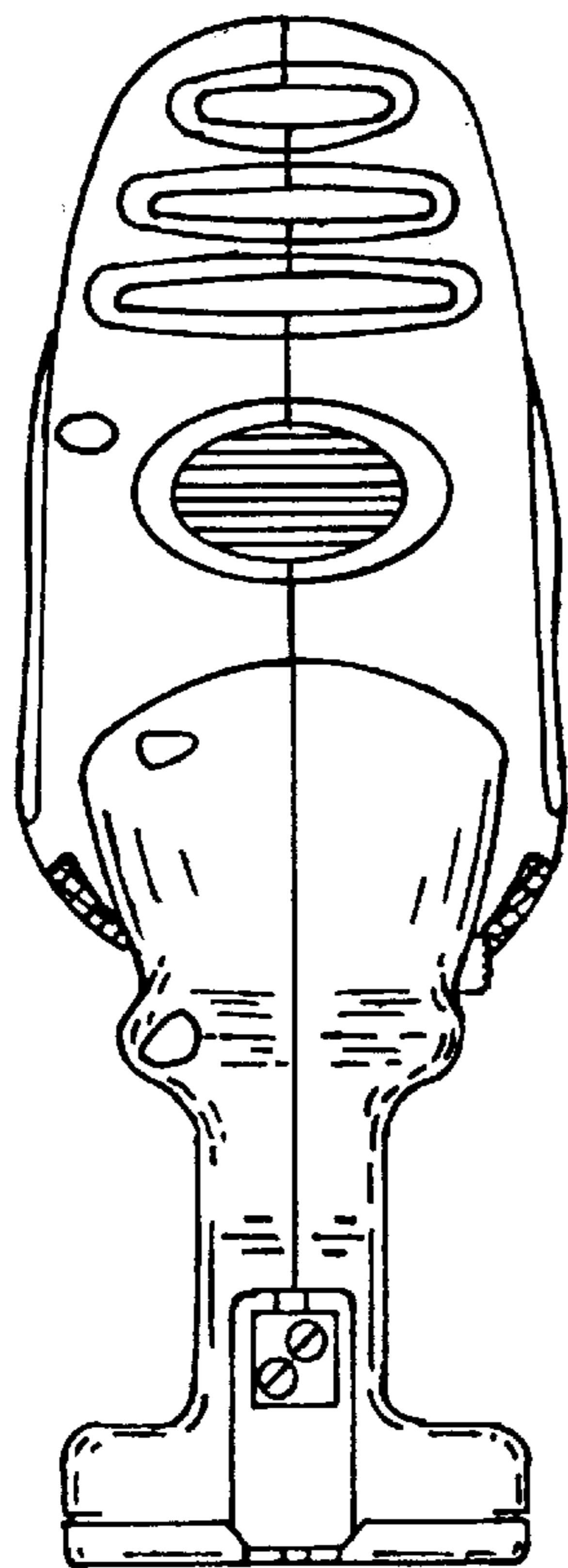

FIG. 6

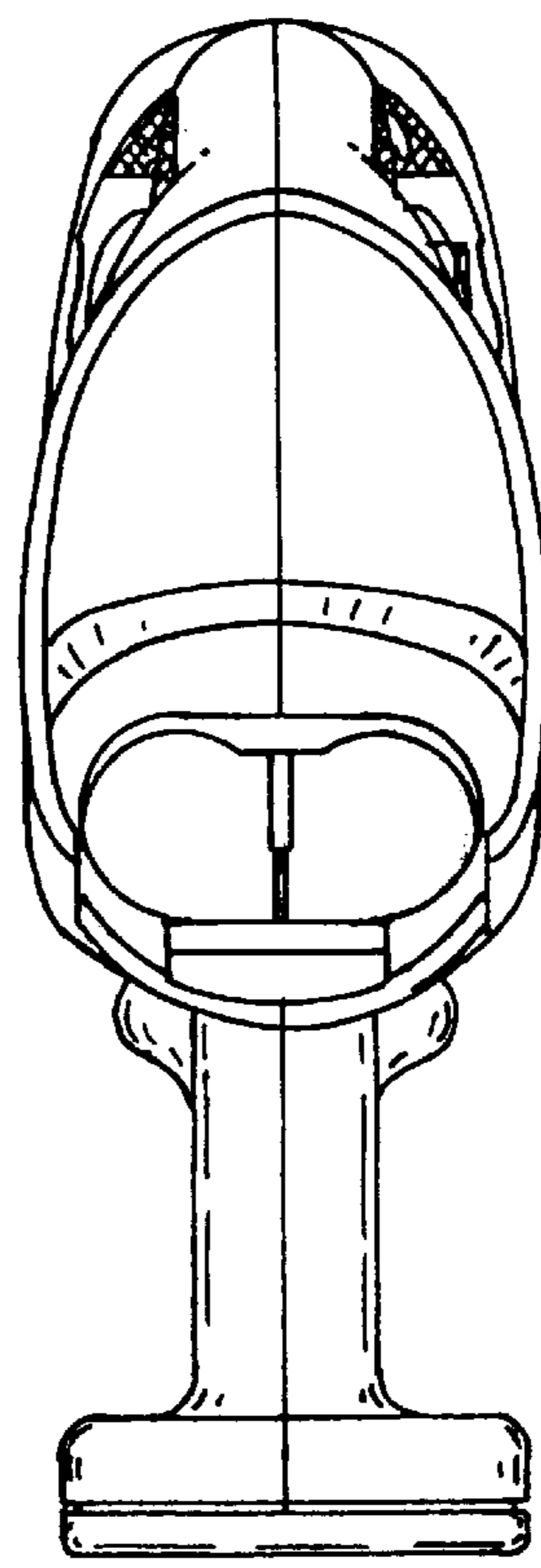

FIG. 7