



US00D423241S

United States Patent [19]

Magnusson et al.

[11] Patent Number: **Des. 423,241**

[45] Date of Patent: **** Apr. 25, 2000**

[54] **CHAIR**

[75] Inventors: **Carl G. Magnusson**, New York, N.Y.;
Michael L. McAllister, Harleysville,
Pa.; **Lamar V. White**, Hereford, Pa.;
William T. Shea, Barto, Pa.

[73] Assignee: **Knoll, Inc.**, East Greenville, Pa.

[**] Term: **14 Years**

[21] Appl. No.: **29/098,991**

[22] Filed: **Jan. 11, 1999**

[51] **LOC (6) Cl.** **06-01**

[52] **U.S. Cl.** **D6/366**

[58] **Field of Search** D6/334, 364, 365,
D6/366, 367, 500, 501, 502; 297/411.2,
411.27, 411.36

[56] **References Cited**

U.S. PATENT DOCUMENTS

D. 274,864 7/1984 Diffrient D6/366
D. 274,867 7/1984 Caldwell D6/366

D. 277,443 2/1985 Murry D6/366
D. 318,577 7/1991 Chadwick et al. D6/366
D. 352,181 11/1994 Ivcevi .
D. 362,973 10/1995 Schultz D6/366
D. 376,924 12/1996 Beaulieu D6/366
D. 378,714 4/1997 Beaulieu D6/366

Primary Examiner—Gary D. Watson
Attorney, Agent, or Firm—Buchanan Ingersoll, P.C.

[57] **CLAIM**

The ornamental design for a chair, as shown and described.

DESCRIPTION

FIG. 1 is a perspective view of a chair showing our new design;
FIG. 2 is a front elevational view thereof;
FIG. 3 is a rear elevational view thereof;
FIG. 4 is a right side elevational view thereof, the left side being a mirror image thereof;
FIG. 5 is a top plan view thereof; and,
FIG. 6 is a bottom plan view thereof.
FIGS. 2 through 6 have been shown on a reduced scale with respect to FIG. 1.

1 Claim, 5 Drawing Sheets

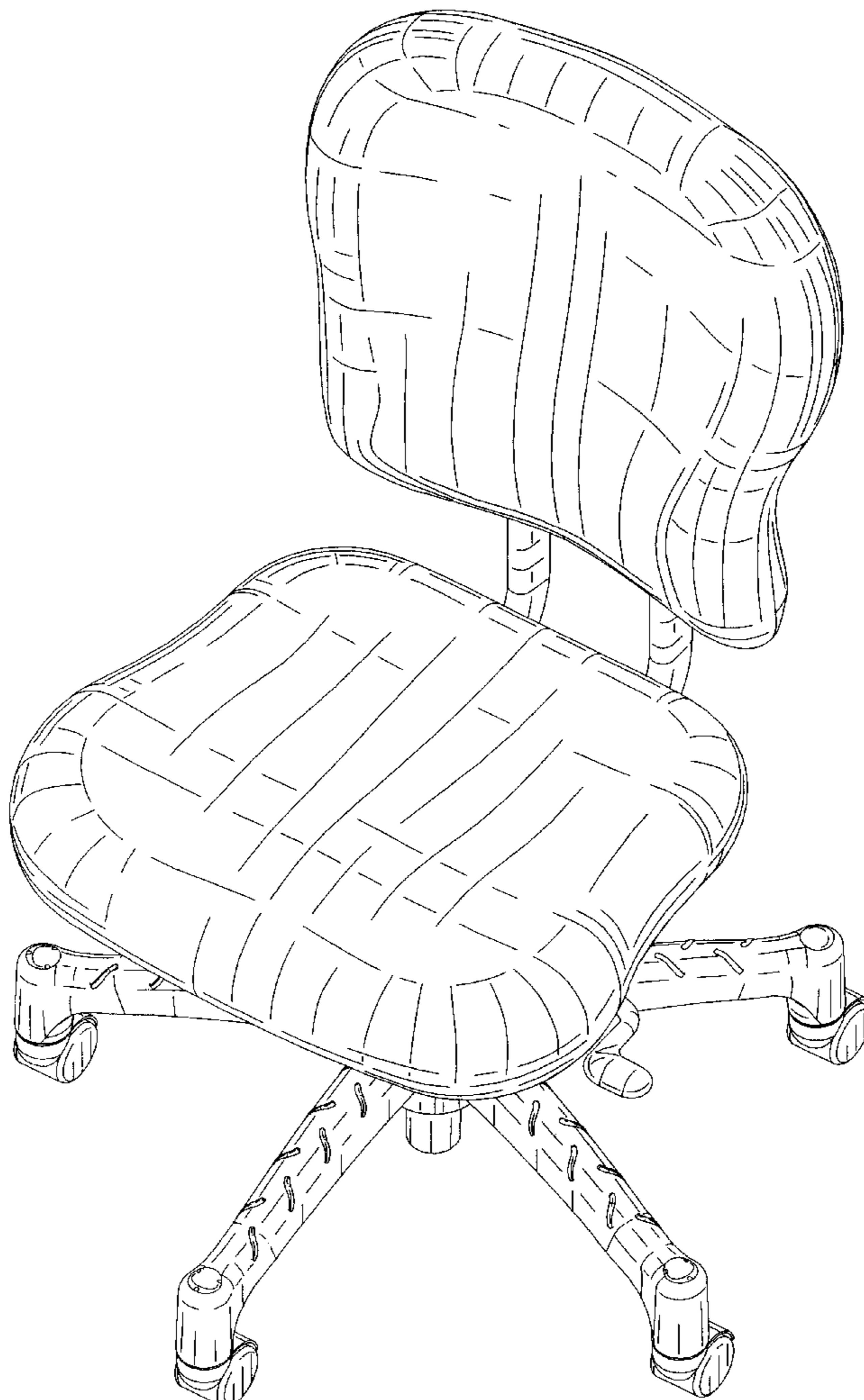

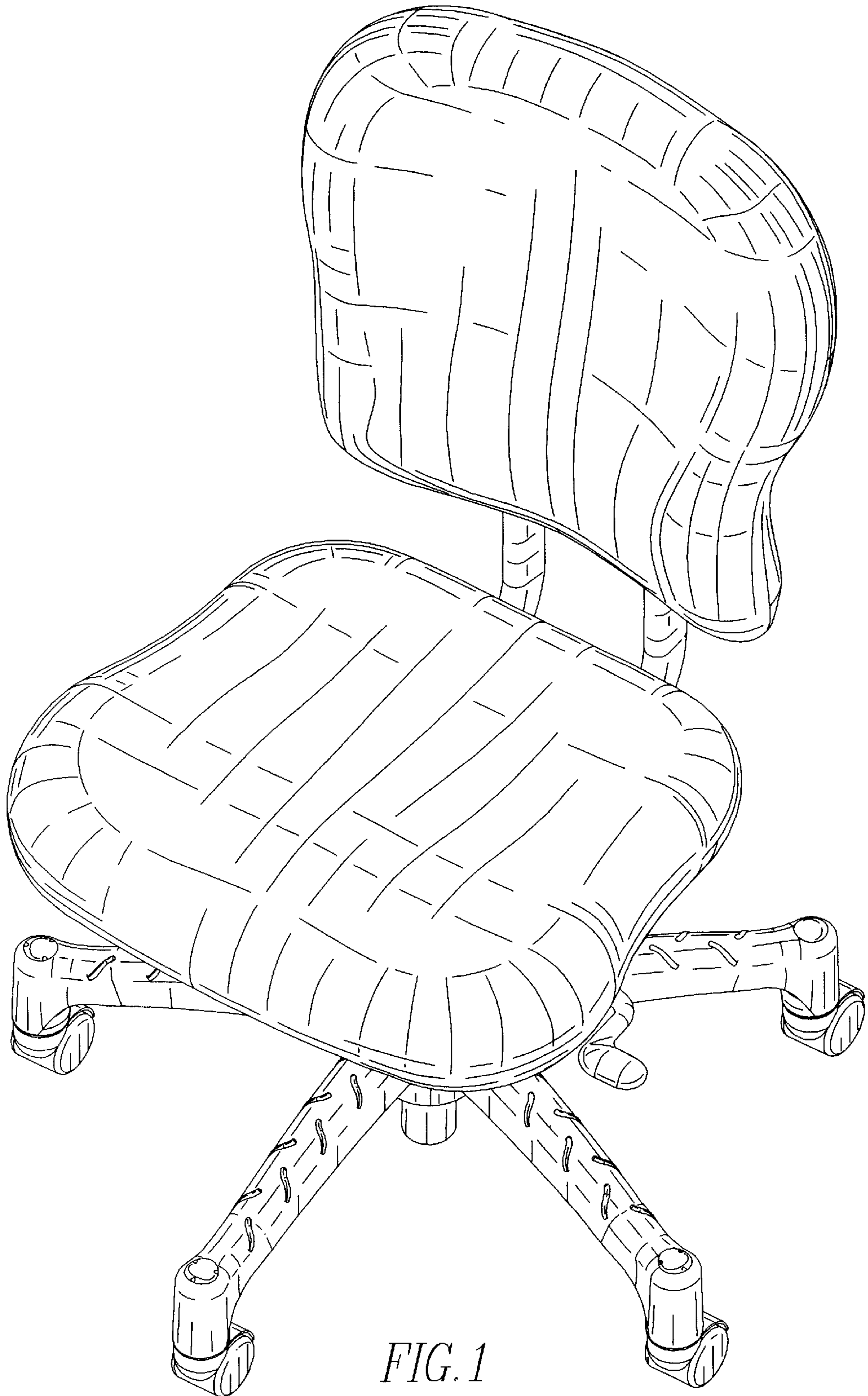

FIG. 1

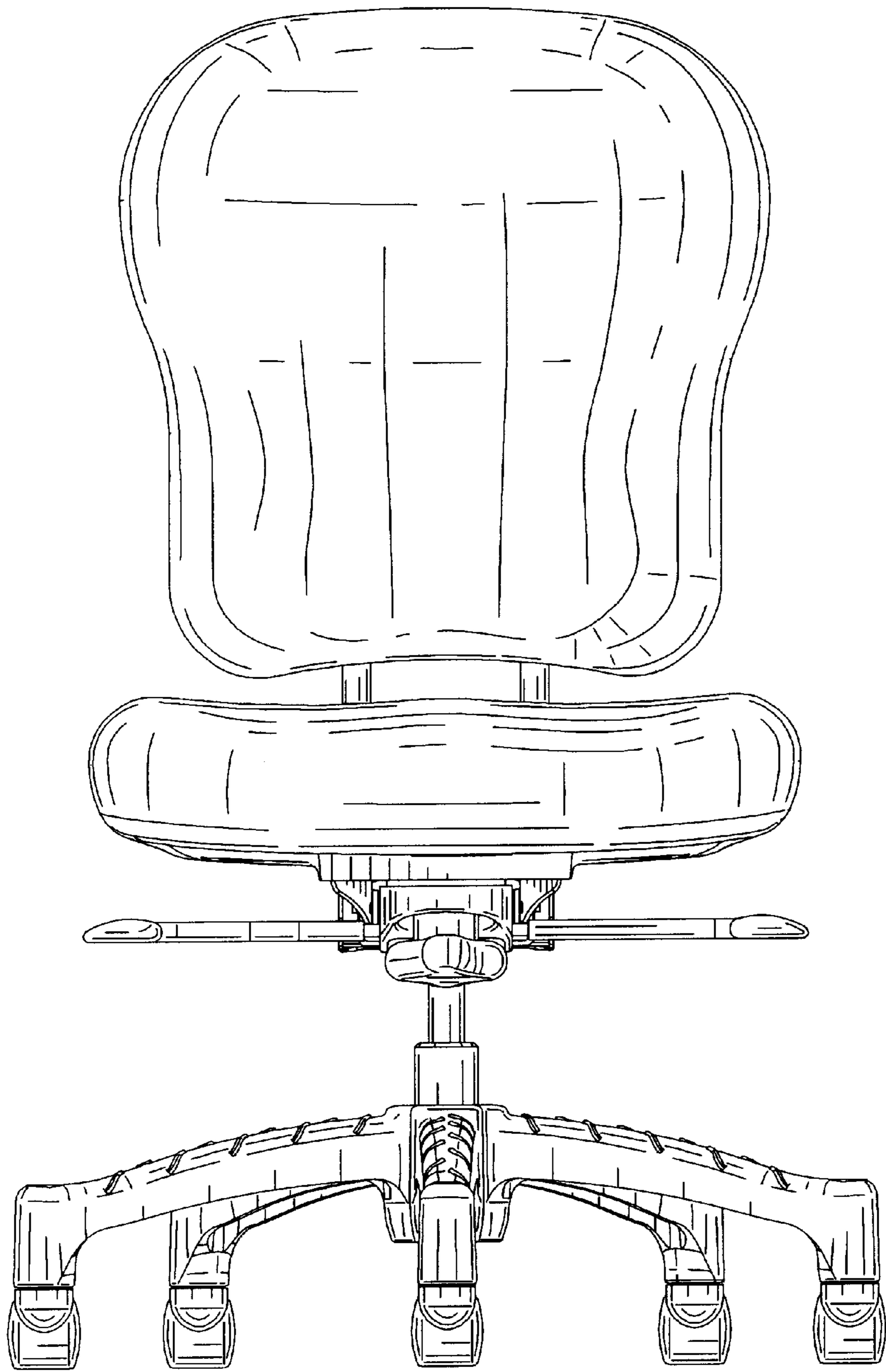

FIG. 2

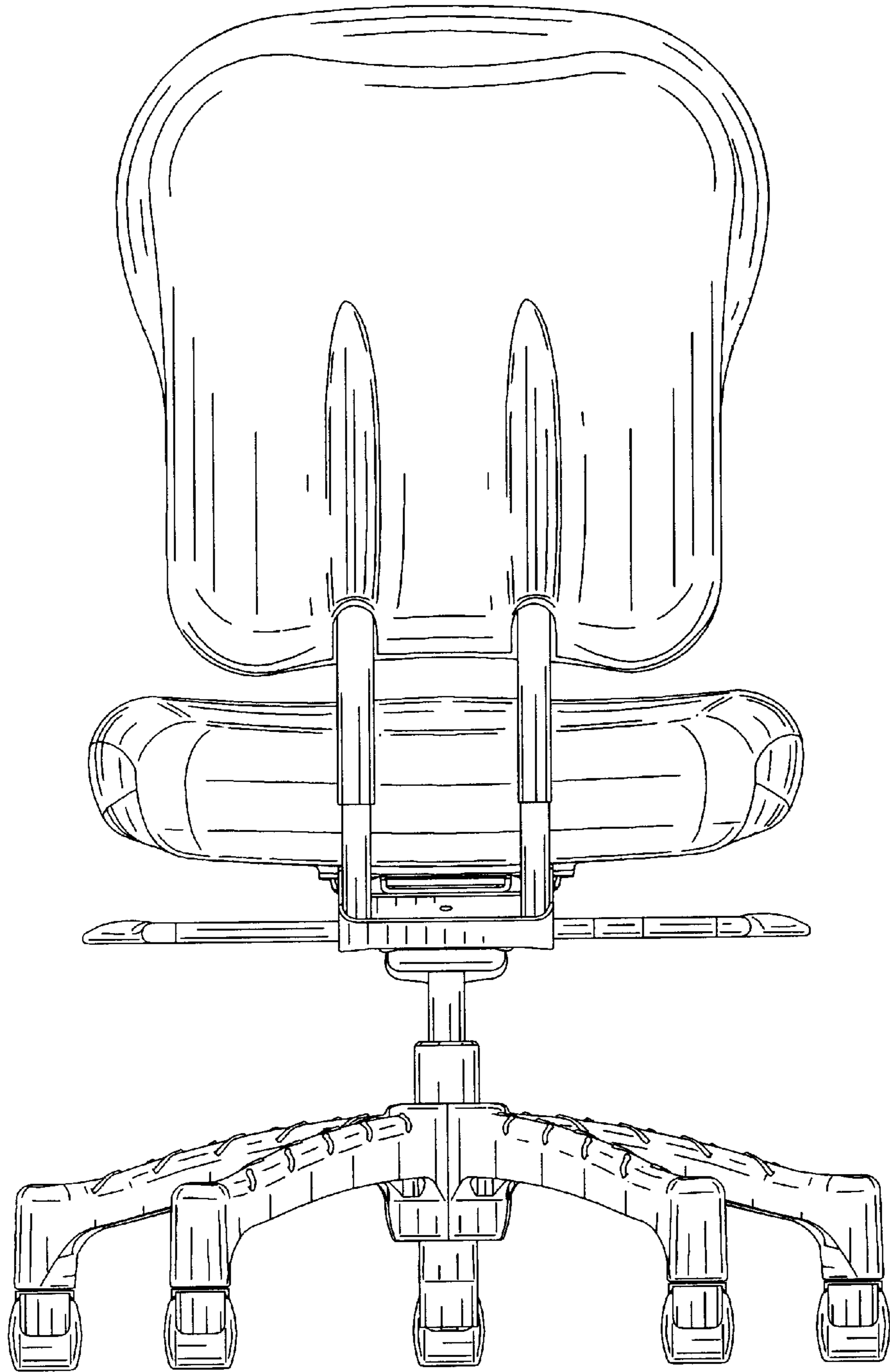

FIG. 3

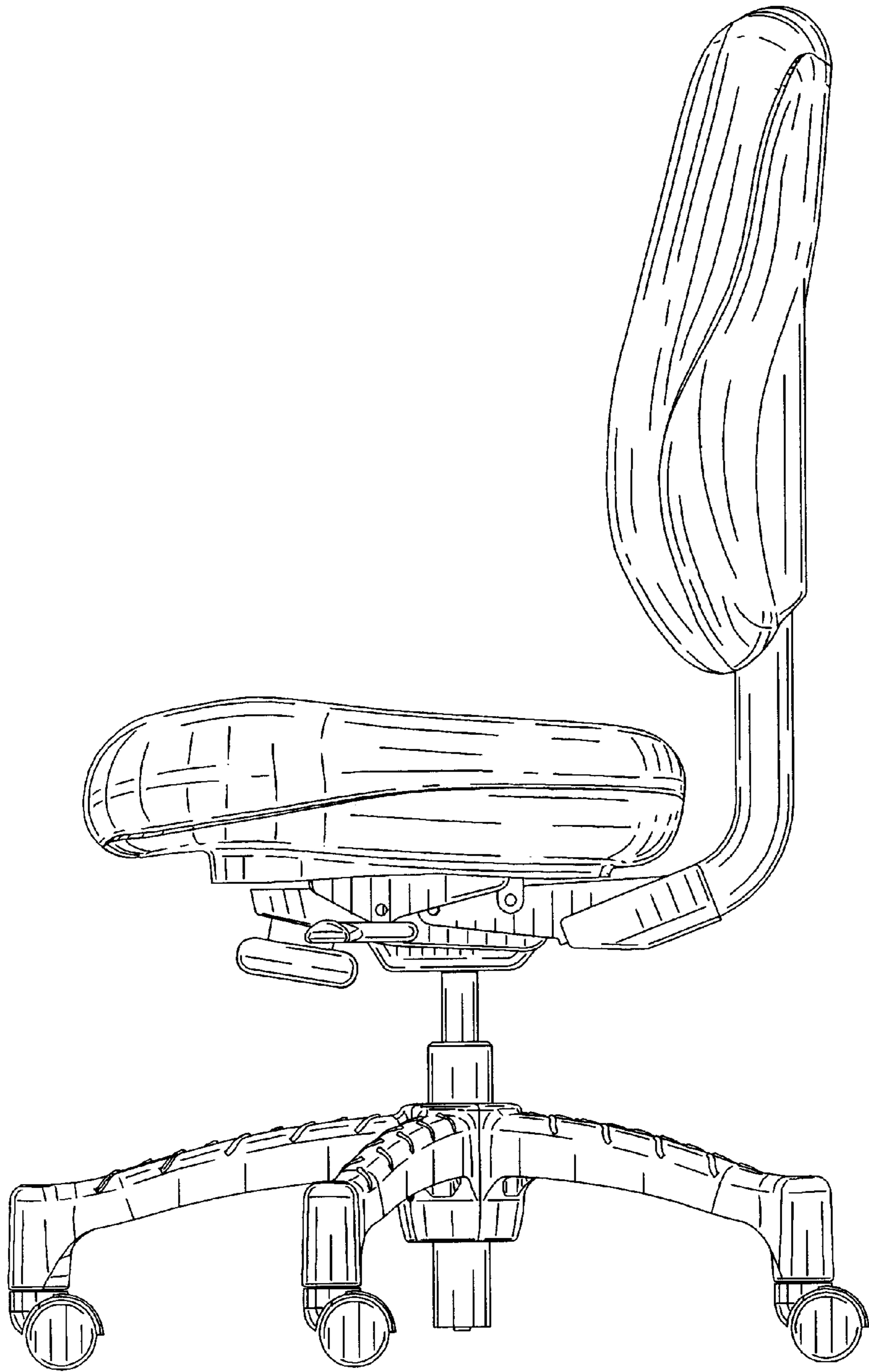

FIG. 4

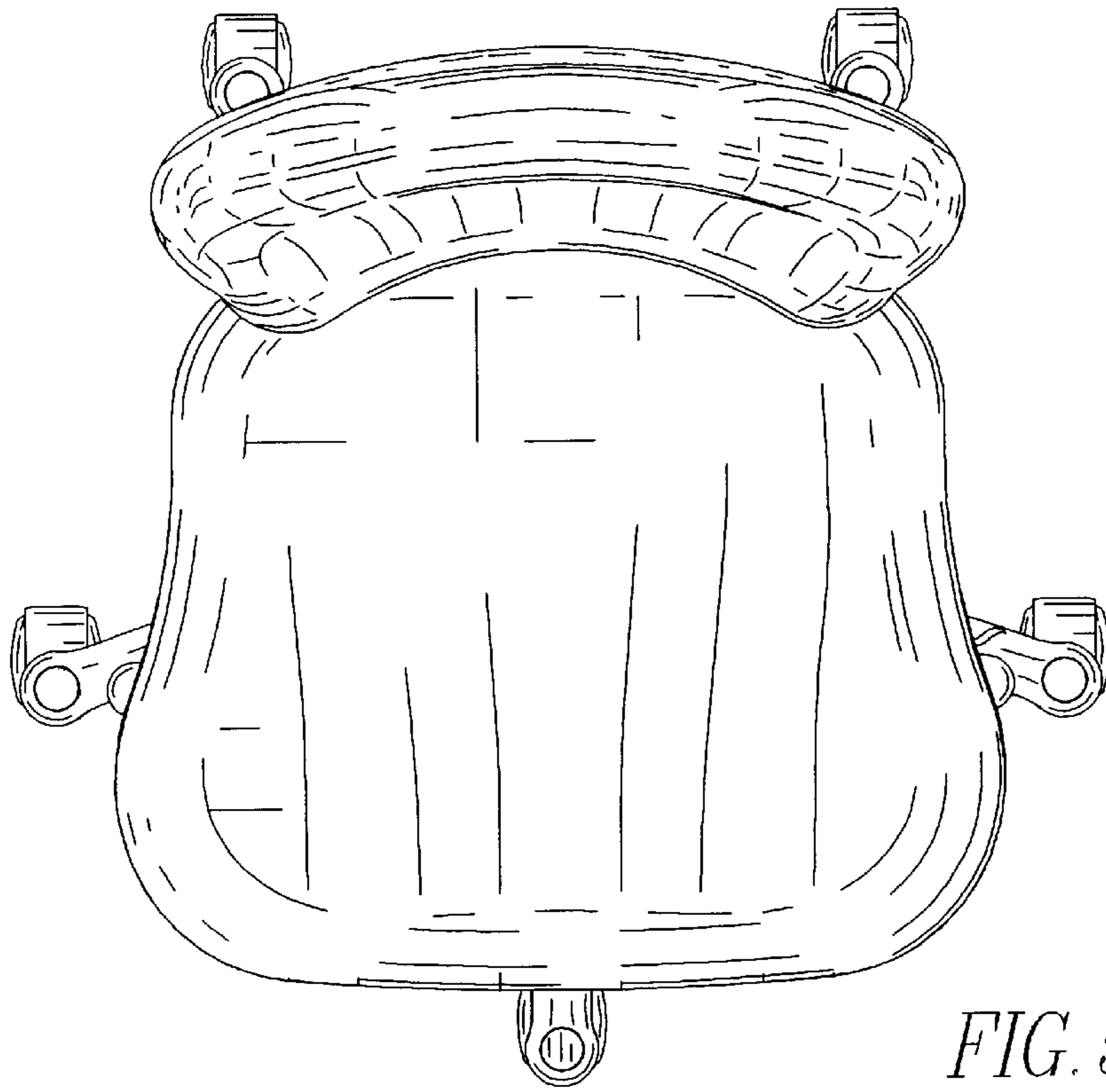

FIG. 5

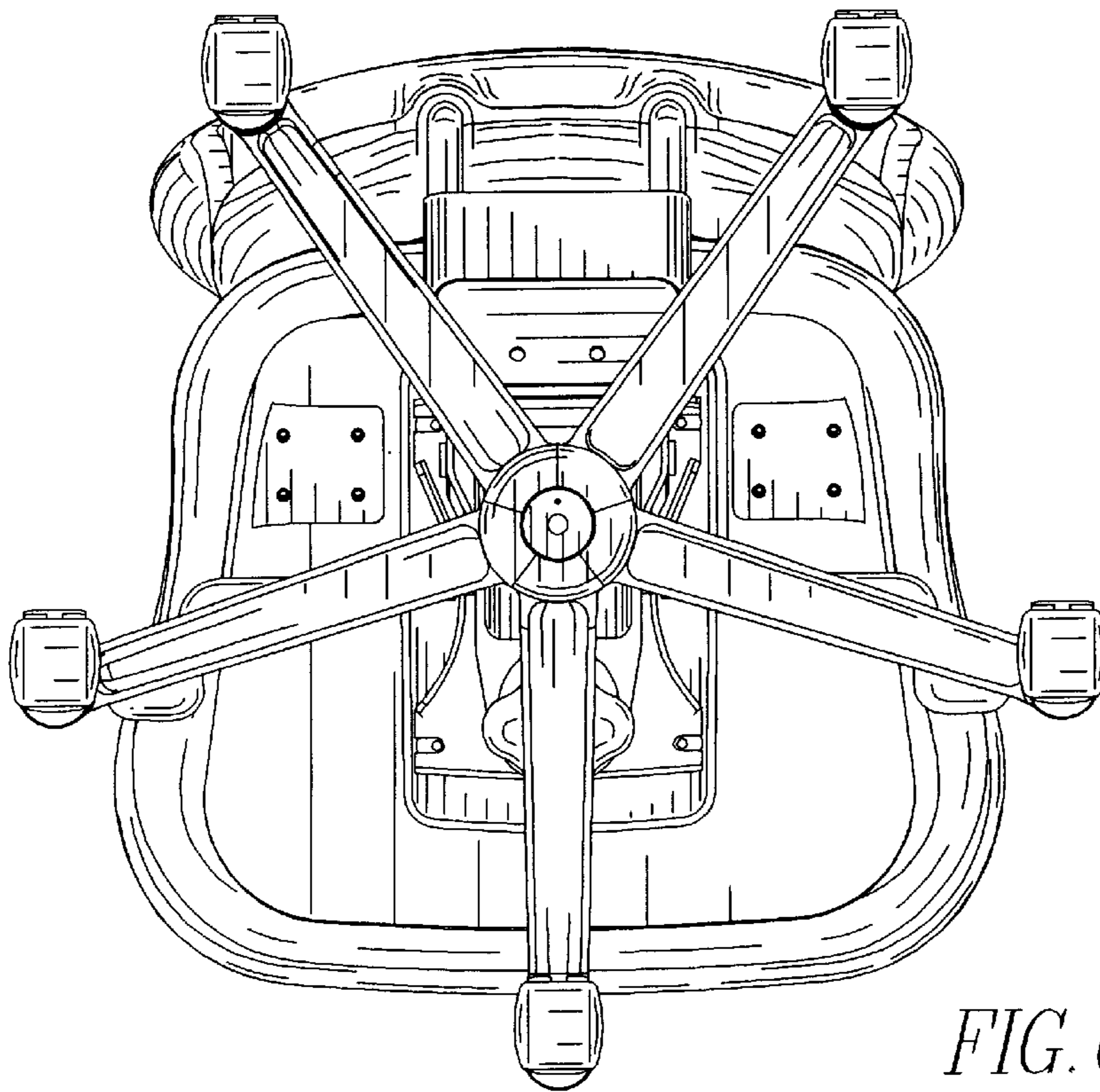

FIG. 6