



US00D423224S

**United States Patent** [19]  
**Sale et al.**

[11] **Patent Number: Des. 423,224**

[45] **Date of Patent: \*\* Apr. 25, 2000**

[54] **ELECTRIC TOOTHBRUSH**

[75] Inventors: **David William Sale**, Heber Springs;  
**Ronald W. Haynes**, Shirley, both of  
Ark.

[73] Assignee: **Professional Dental Technologies, Inc.**,  
Batesville, Ark.

[\*\*] Term: **14 Years**

[21] Appl. No.: **29/109,134**

[22] Filed: **Aug. 10, 1999**

[51] **LOC (6) Cl.** ..... **04-02**

[52] **U.S. Cl.** ..... **D4/101; D4/111**

[58] **Field of Search** ..... D4/101, 104, 108,  
D4/109, 111, 112, 138; 15/22.1, 22.2, 28,  
29, 143.1, 167.1; 132/308, 311; 433/118,  
125; 601/142

[56] **References Cited**

**U.S. PATENT DOCUMENTS**

D. 388,958 1/1998 Hartwein ..... D4/101

D. 411,769 7/1999 Wright ..... D4/101  
3,848,336 11/1974 Copeland ..... 15/28 X  
5,208,933 5/1993 Lustid et al. .... 15/22.1  
5,341,534 8/1994 Serbinski ..... 15/22.1

*Primary Examiner*—Alan P. Douglas  
*Assistant Examiner*—Lavone Tabor  
*Attorney, Agent, or Firm*—Nims, Howes, Collison, Hansen  
& Lackert

[57] **CLAIM**

The ornamental design for an electric toothbrush, as shown  
and described.

**DESCRIPTION**

FIG. 1 is a perspective view of an electric toothbrush,  
showing our new design;  
FIG. 2 is an exploded perspective view thereof;  
FIG. 3 is a front view thereof;  
FIG. 4 is a side view thereof, the opposite side being a mirror  
image thereof;  
FIG. 5 is a rear view thereof;  
FIG. 6 is a top view thereof; and,  
FIG. 7 is a bottom view if the electric toothbrush.

**1 Claim, 4 Drawing Sheets**

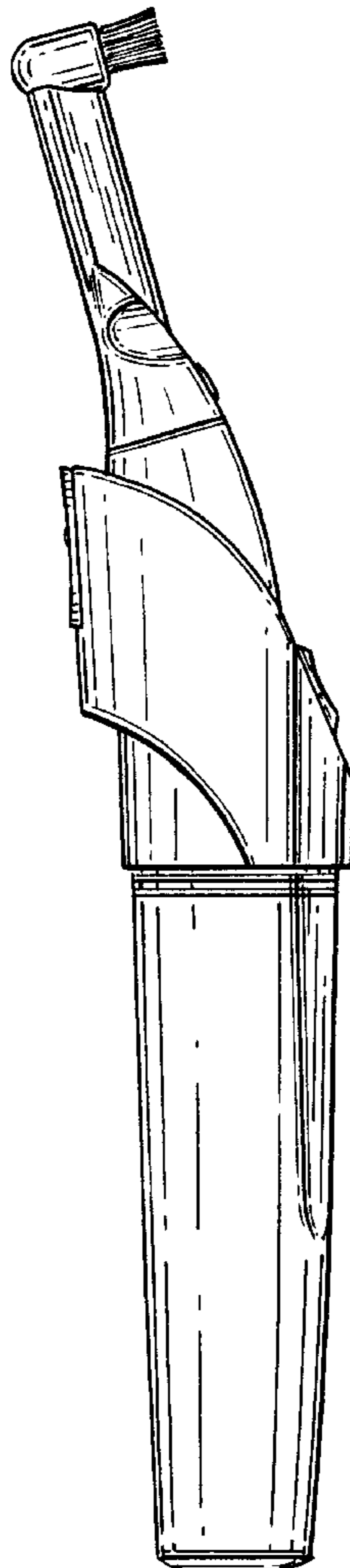
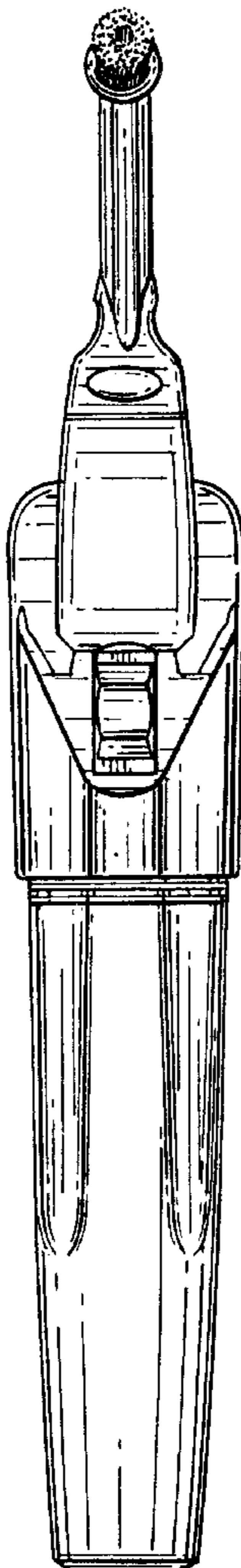

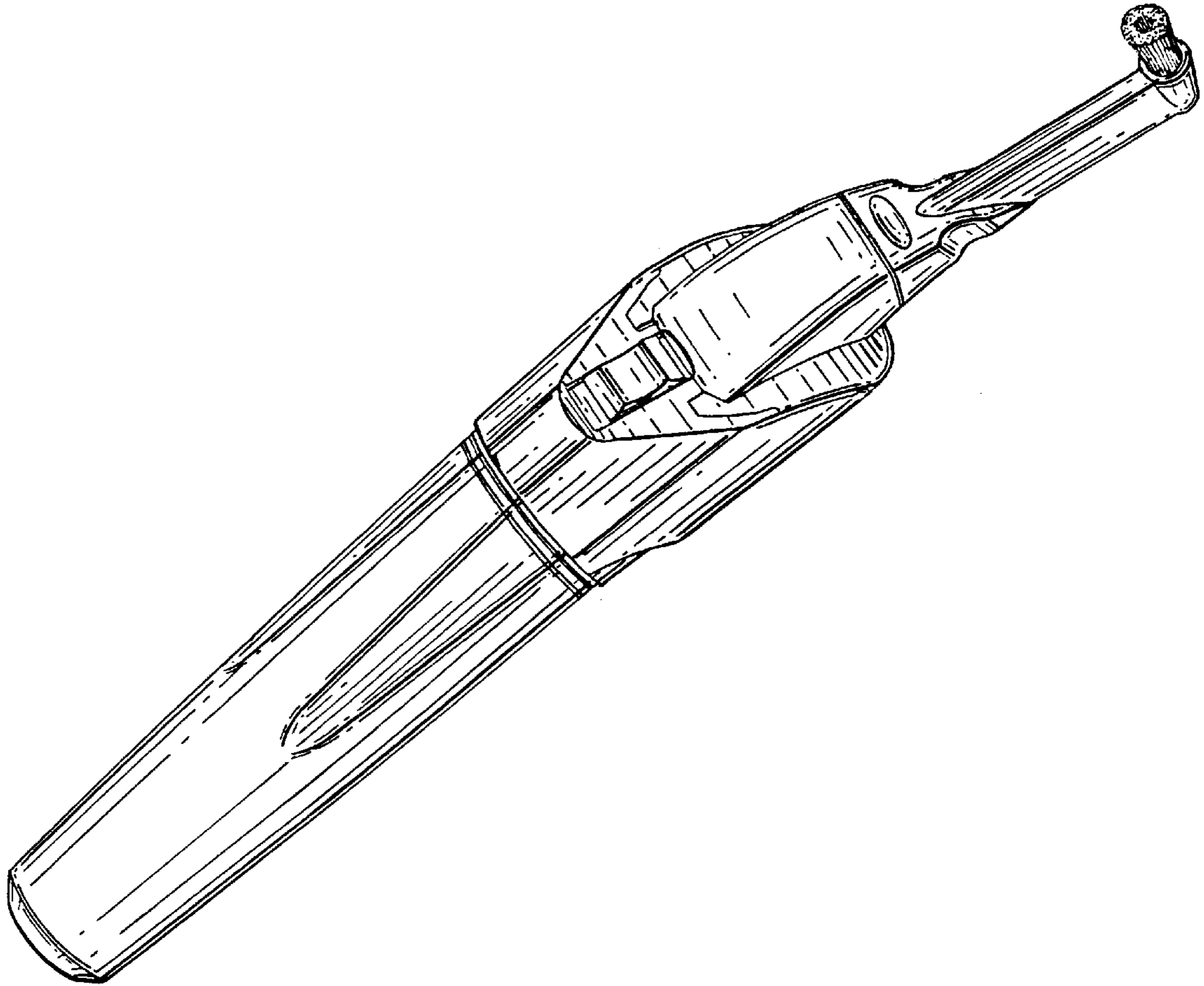

FIG. 1

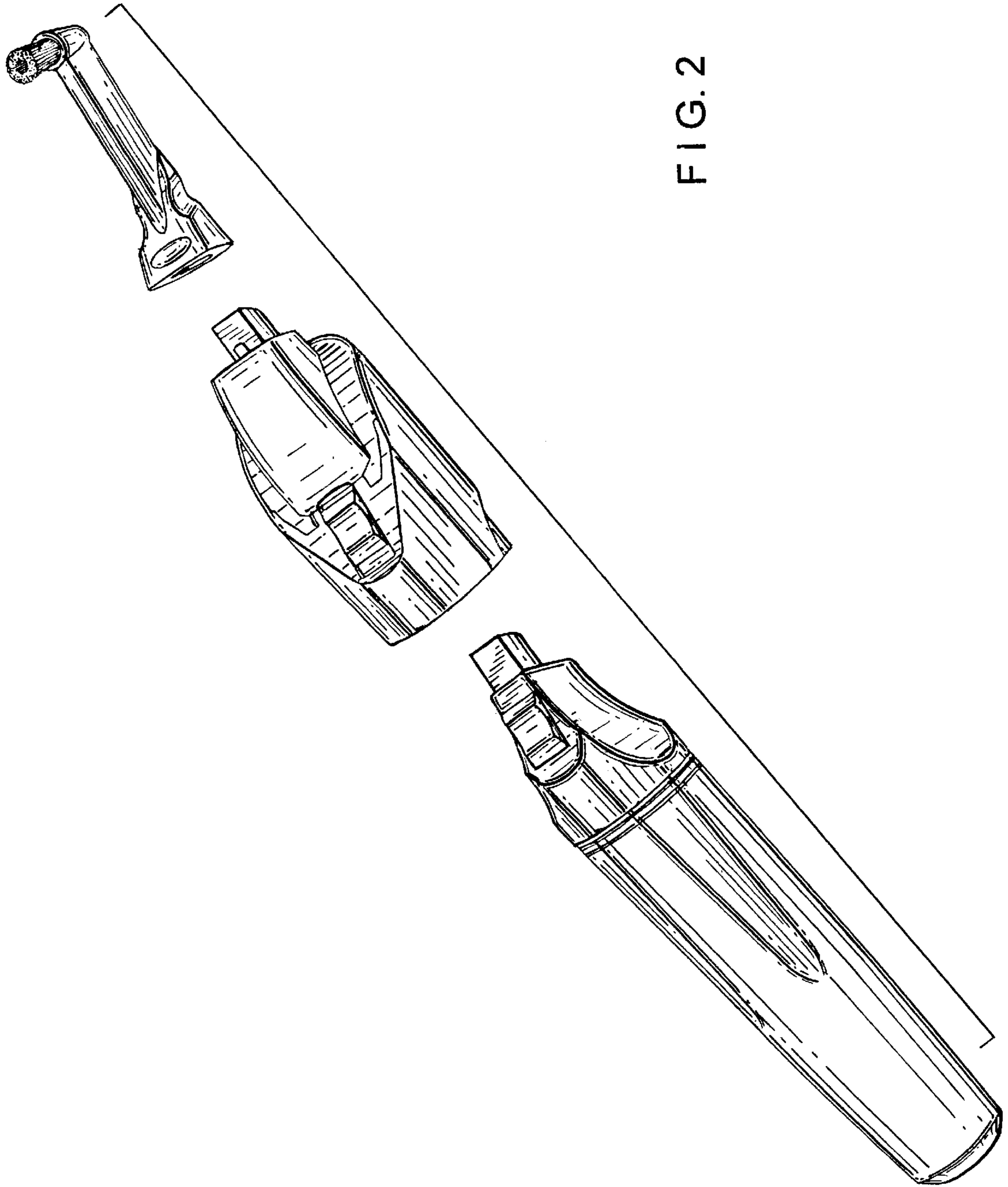

FIG. 2

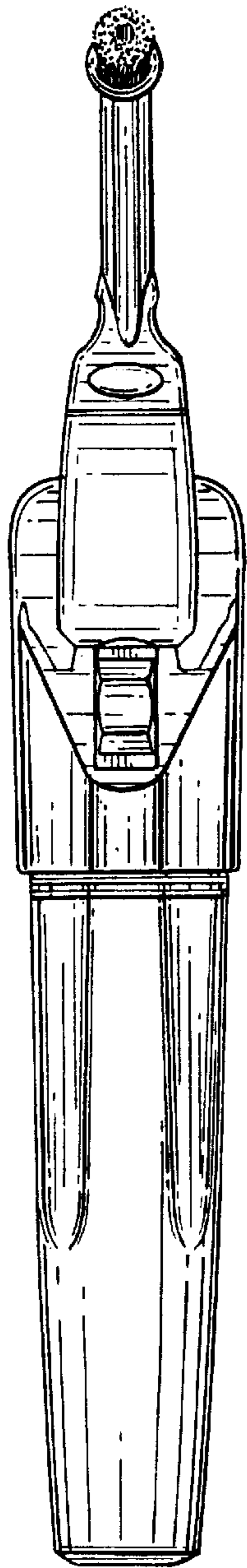

FIG. 3

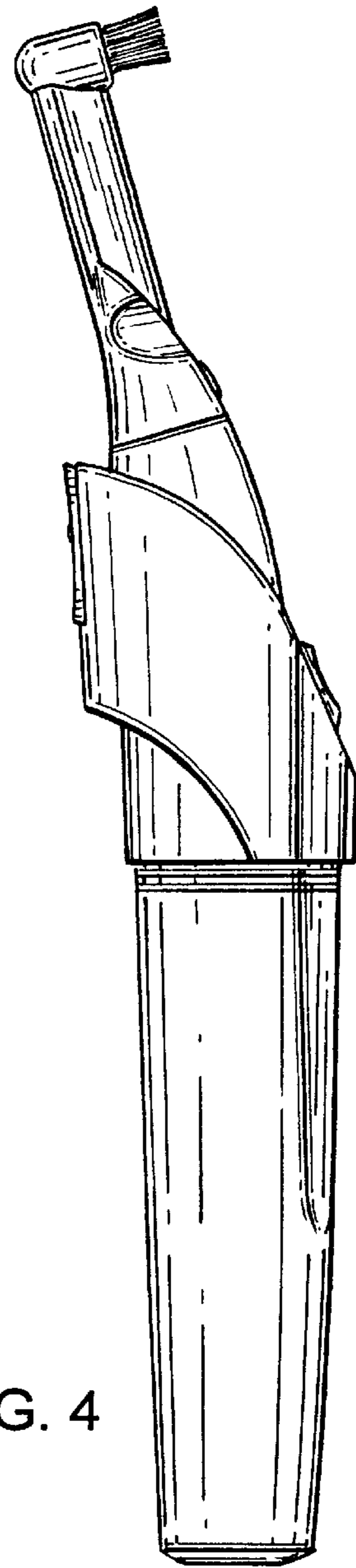

FIG. 4

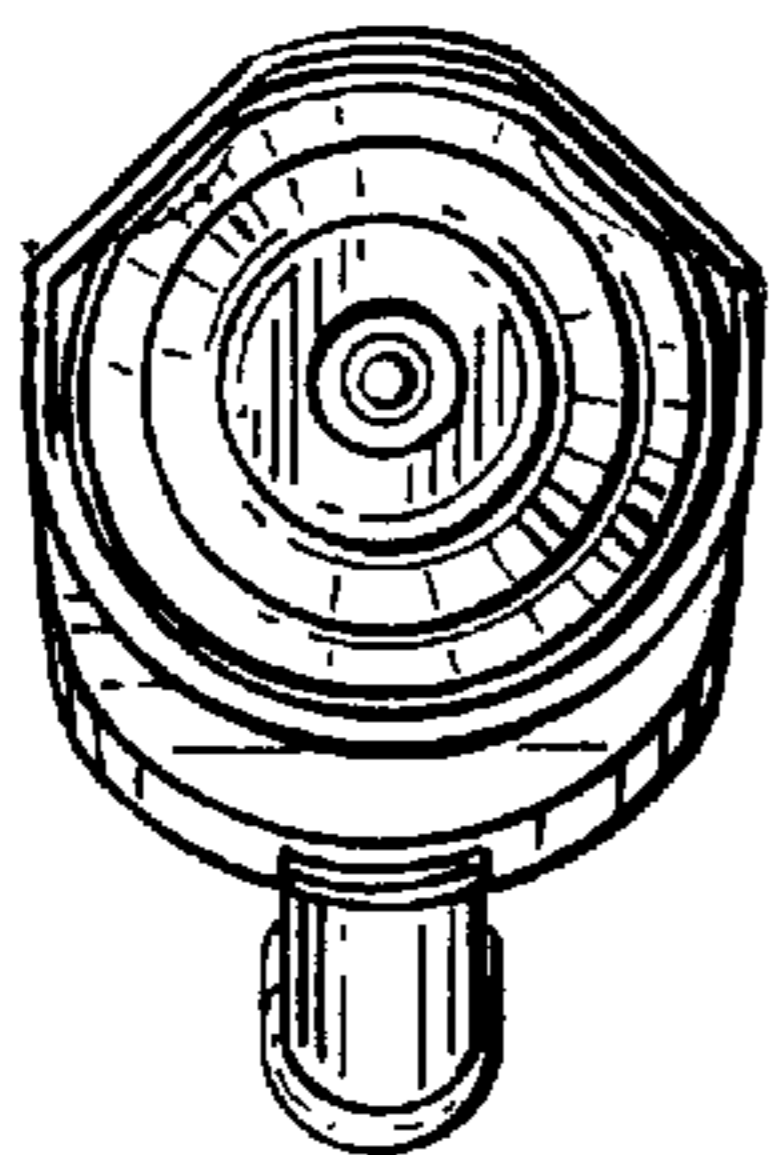

FIG. 7

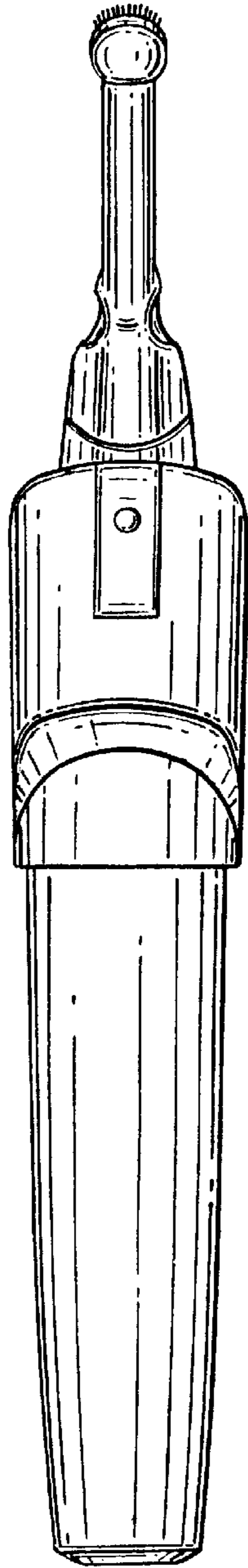

FIG. 5

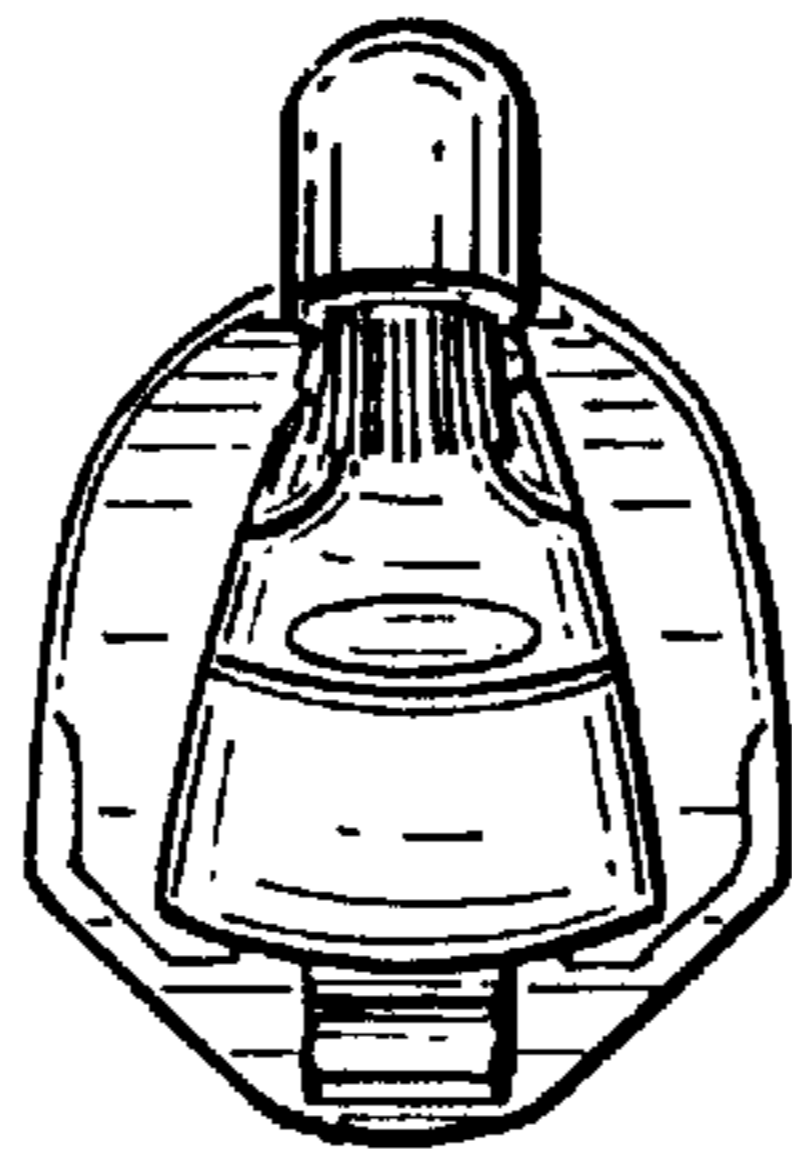

FIG. 6