



US00D423045S

United States Patent [19] Ko

[11] Patent Number: Des. 423,045

[45] Date of Patent: ** Apr. 18, 2000

[54] METAL RING BINDER

[75] Inventor: Chung Nin Ko, Kowloon, The Hong Kong Special Administrative Region of the People's Republic of China

[73] Assignee: Hong Kong Stationery Manufacturing Co., Ltd., Kowloon, The Hong Kong Special Administrative Region of the People's Republic of China

[**] Term: 14 Years

[21] Appl. No.: 29/099,680

[22] Filed: Jan. 26, 1999

[51] LOC (6) Cl. 19-04

[52] U.S. Cl. D19/32

[58] Field of Search D19/96, 27, 32;
281/27.1, 27.2, 27.3, 45, 51; 402/26, 31,
41, 60, 70, 80 R

[56] References Cited

U.S. PATENT DOCUMENTS

D. 389,182	1/1998	Law	D19/32
D. 392,673	3/1998	Whaley	D19/32
D. 397,146	8/1998	Chan	D19/32
D. 405,113	2/1999	Ko	D19/27
D. 409,240	5/1999	Ko	D19/32
5,807,006	9/1998	Cheung	402/38
5,842,807	12/1998	To	402/36

OTHER PUBLICATIONS

Hornung—Background Patterns, Textures and Tints—1976—(no page #s)—.

Primary Examiner—Nelson C. Holtje

Attorney, Agent, or Firm—Shoemaker and Mattare, Ltd.

[57] CLAIM

The ornamental design for a metal ring binder, as shown and described.

DESCRIPTION

FIG. 1 is a perspective view, from above and to one side of a metal ring binder, showing my new design;

FIG. 2 is a top plan view thereof;

FIG. 3 is a bottom plan view thereof;

FIG. 4 is a side elevation thereof, the view from the opposite side being identical; and

FIG. 5 is an end view thereof, the view from the opposite end being identical.

FIG. 6 is a perspective view, from above and to one side of a metal ring binder, showing a first variation of my design;

FIG. 7 is a top plan view thereof;

FIG. 8 is a bottom plan view thereof;

FIG. 9 is a side elevation thereof, the view from the opposite side being identical; and

FIG. 10 is an end view thereof, the view from the opposite end being identical.

FIG. 11 is a perspective view, from above and to one side, showing a second variation of my design;

FIG. 12 is a top plan view thereof;

FIG. 13 is a bottom plan view thereof;

FIG. 14 is a side elevation thereof, the view from the opposite side being identical; and,

FIG. 15 is an end view thereof, the view from the opposite end being identical.

1 Claim, 9 Drawing Sheets

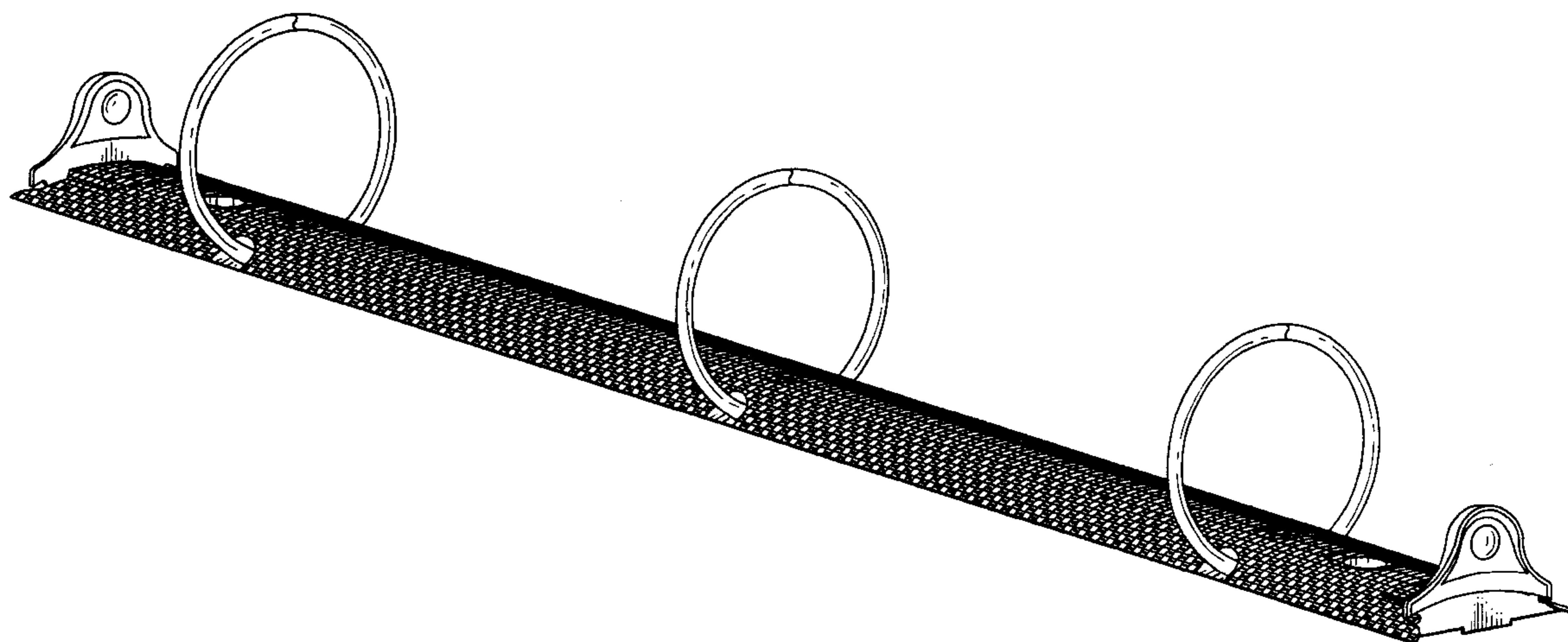

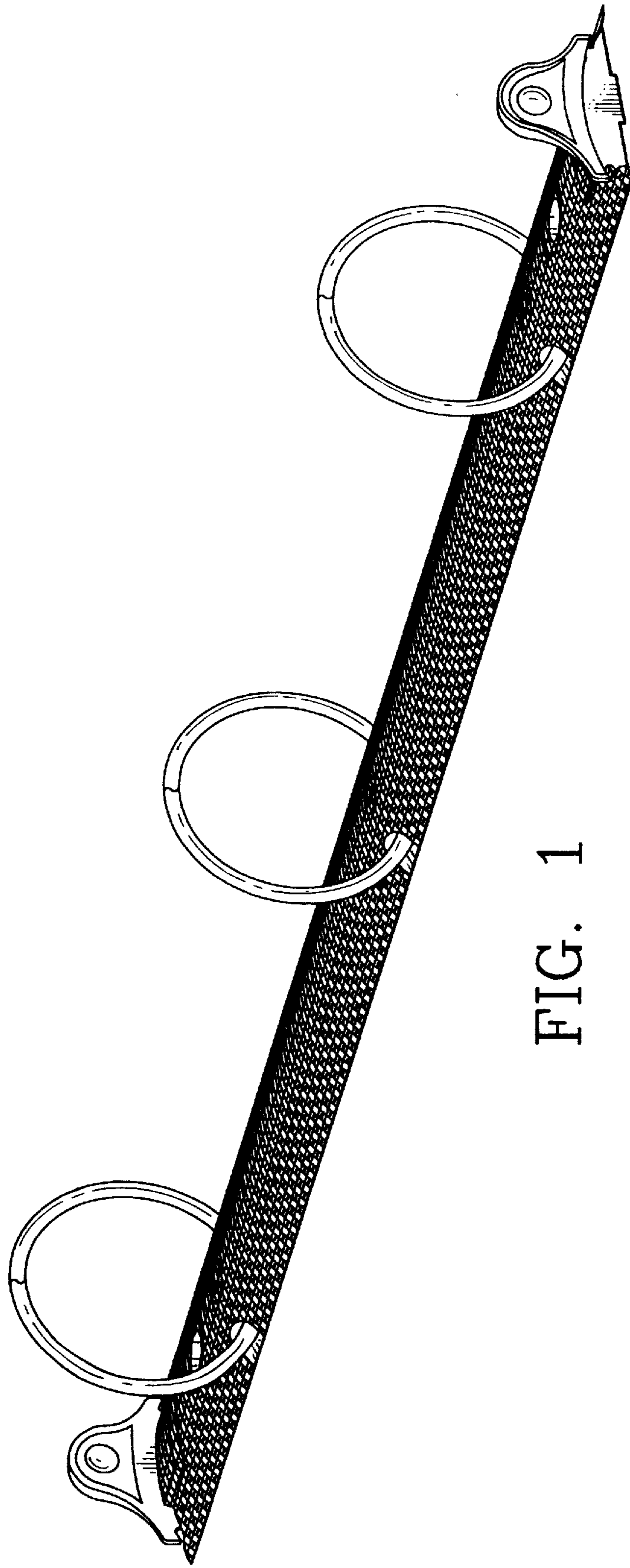

FIG. 1

FIG. 2

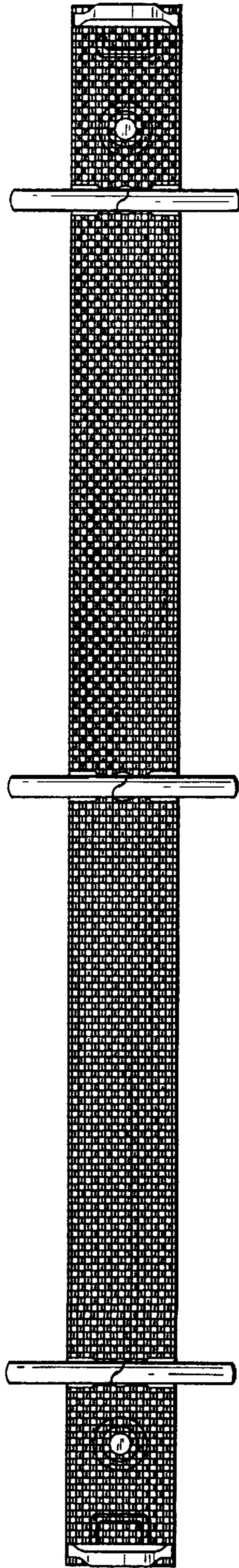

FIG. 3

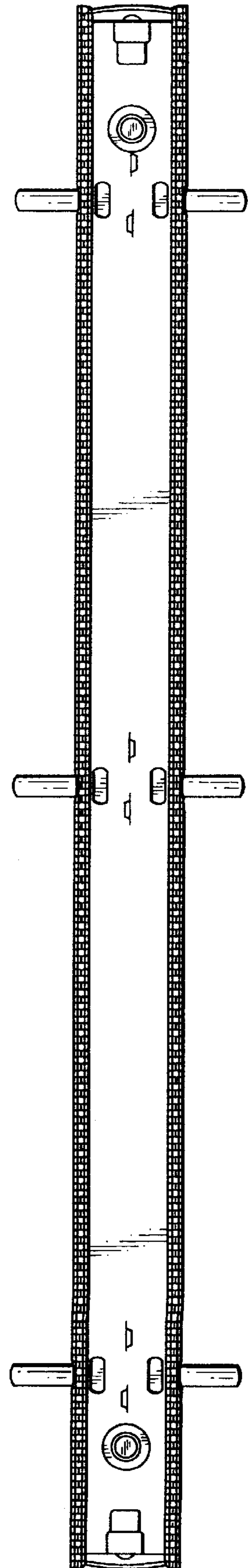

FIG. 4

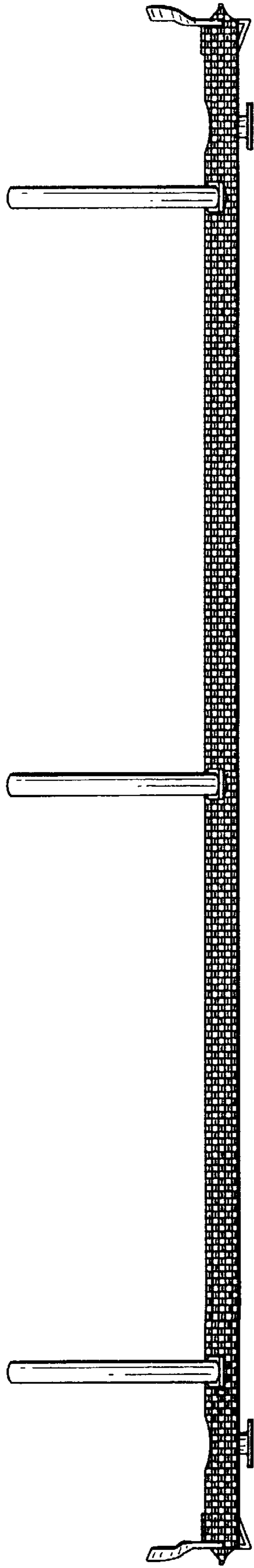
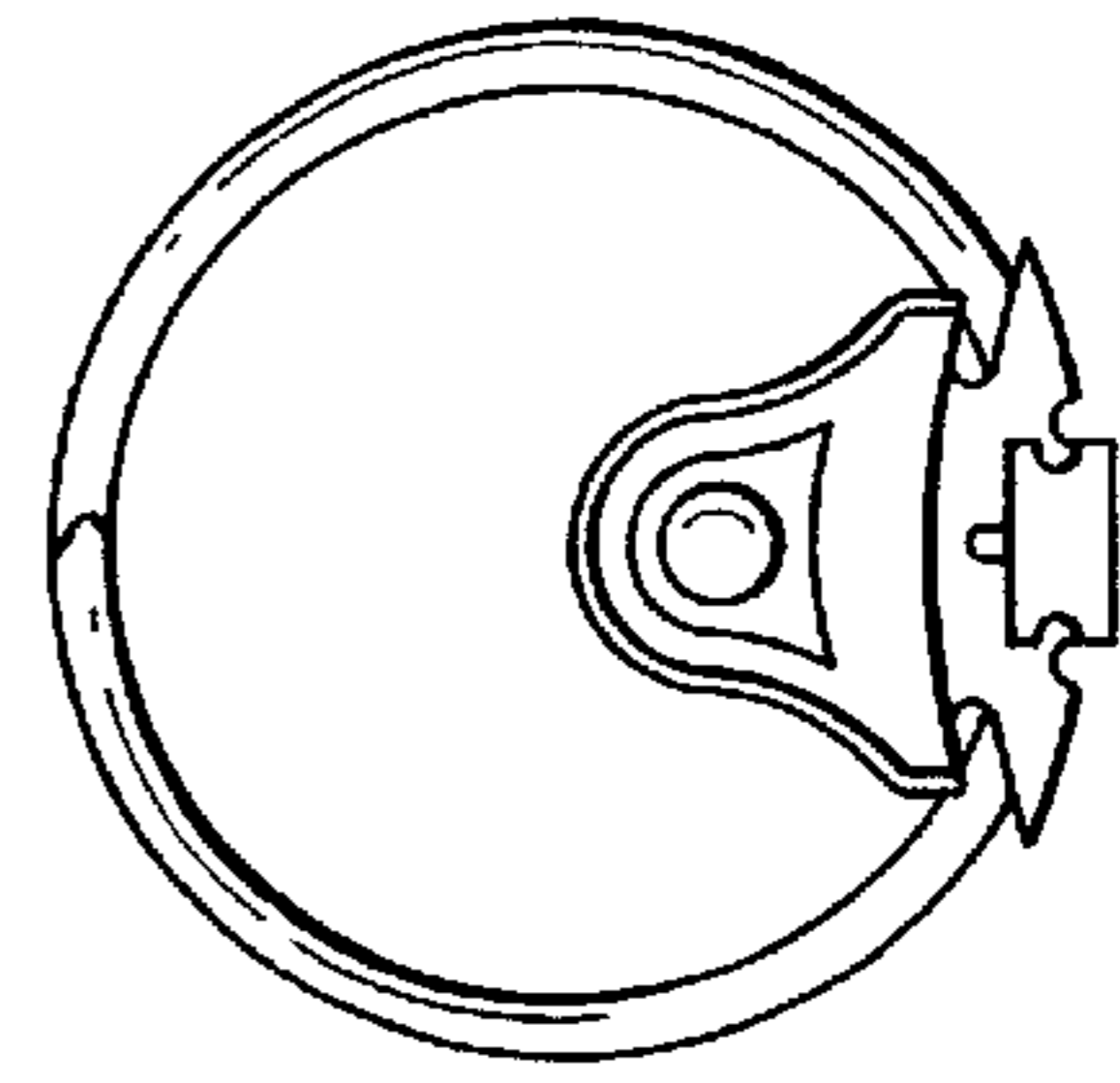

FIG. 5



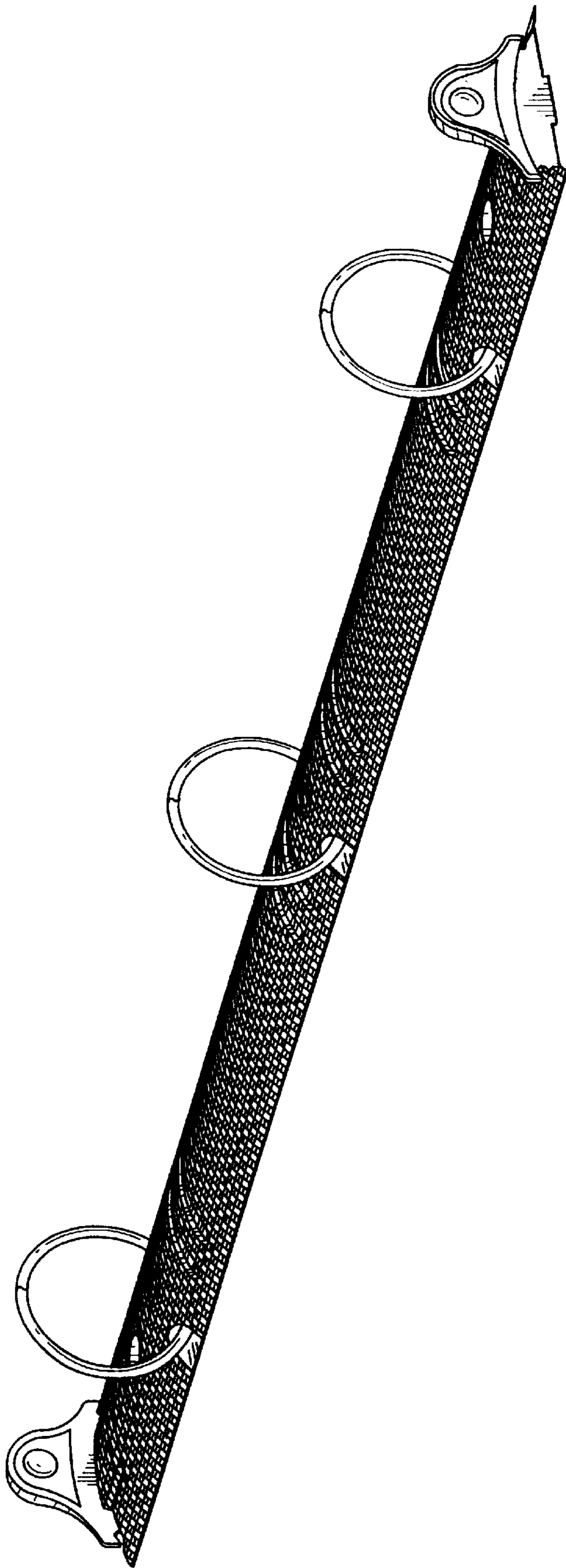

FIG. 6

FIG. 7

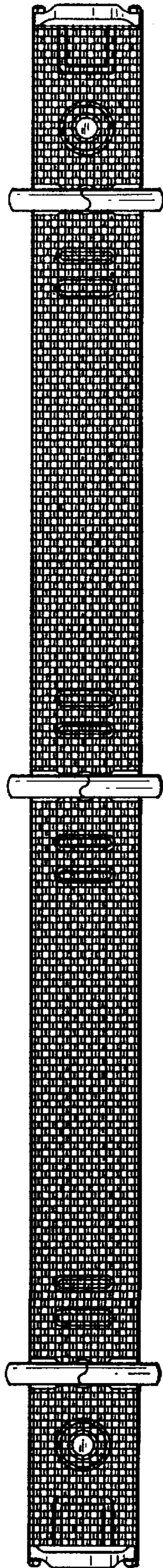

FIG. 8

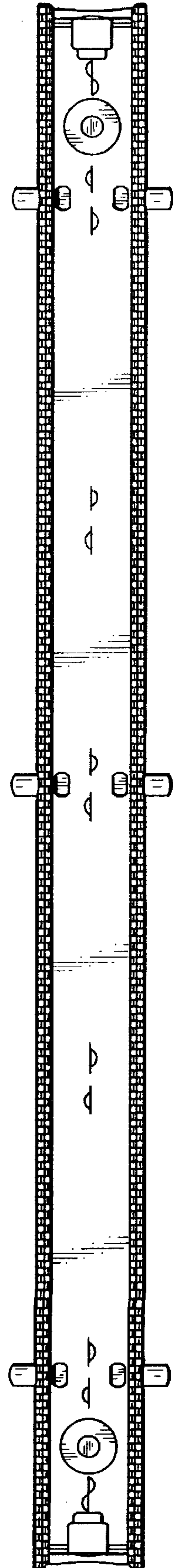

FIG. 9

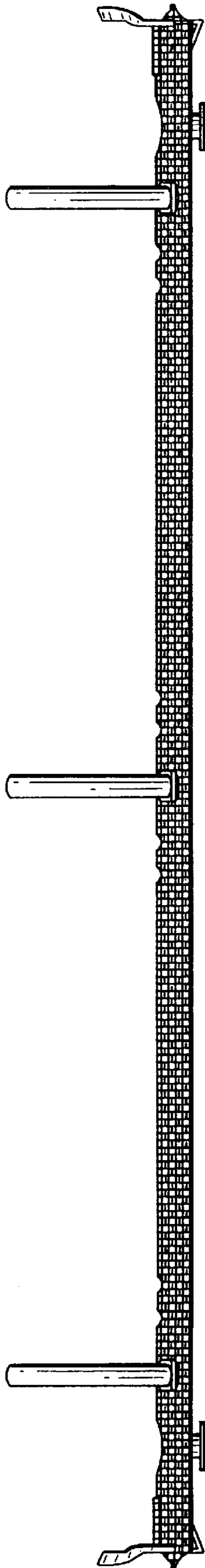
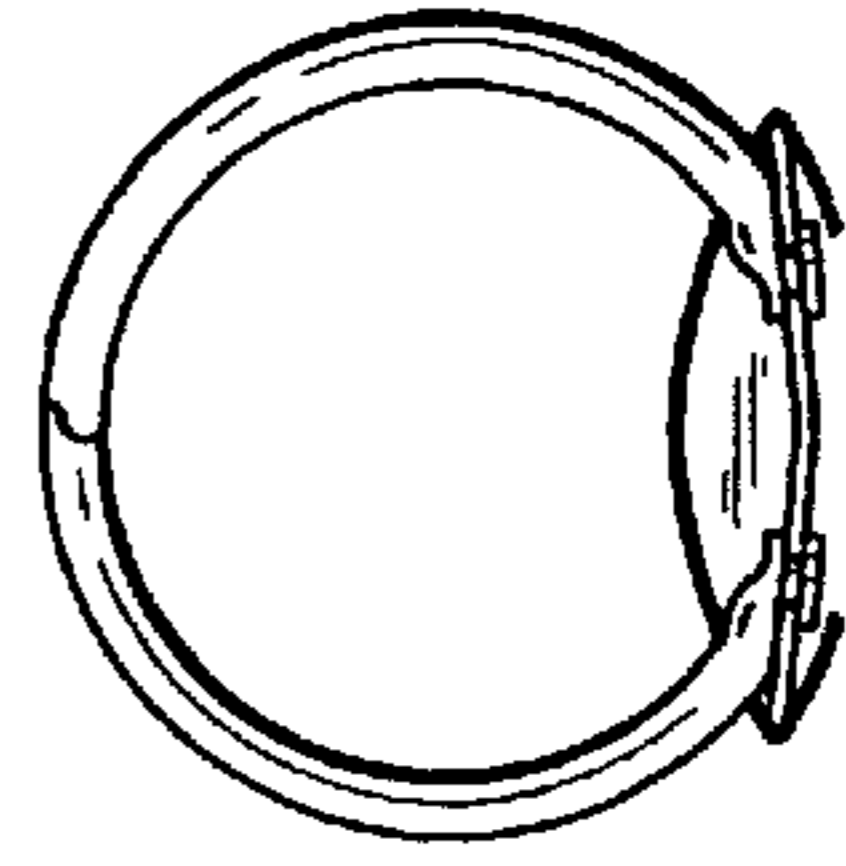

FIG. 10



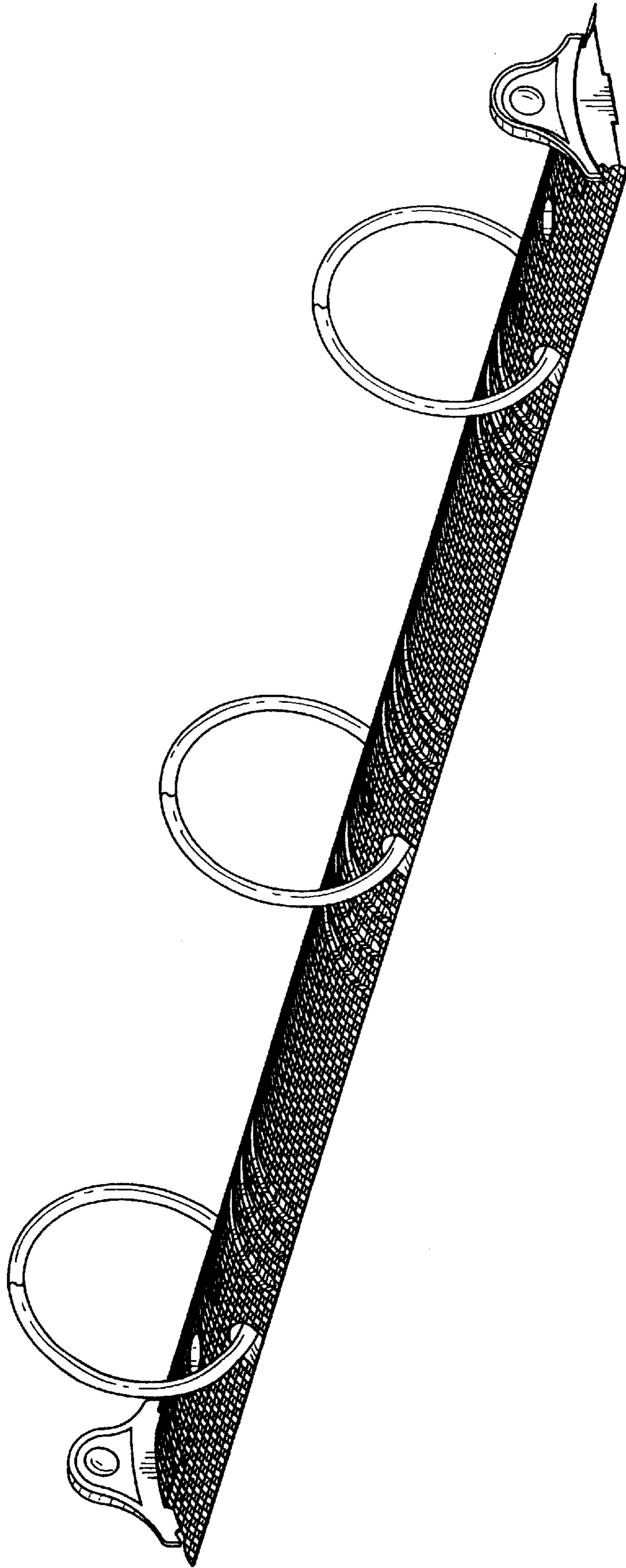

FIG. 11

FIG. 12

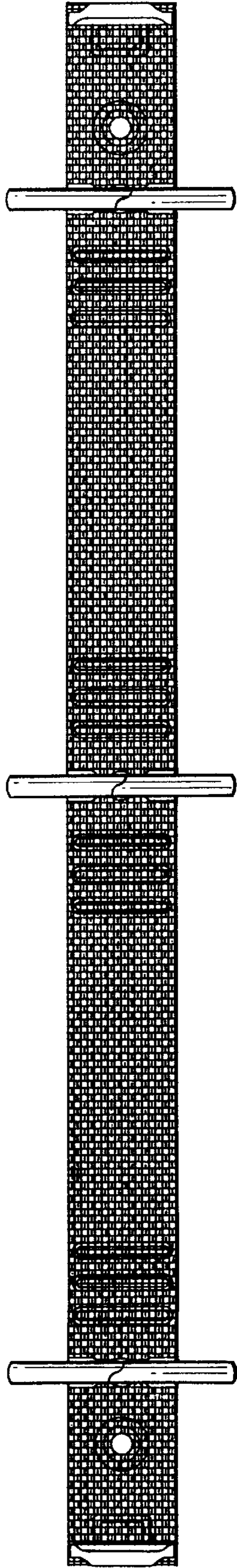

FIG. 13

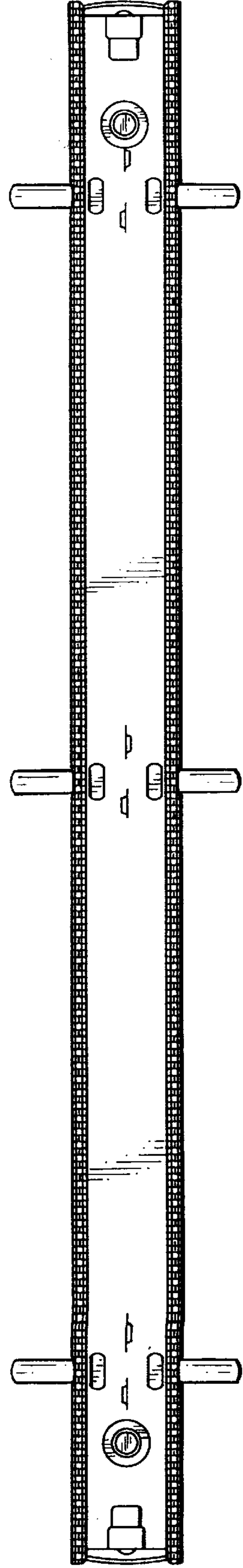

FIG. 14

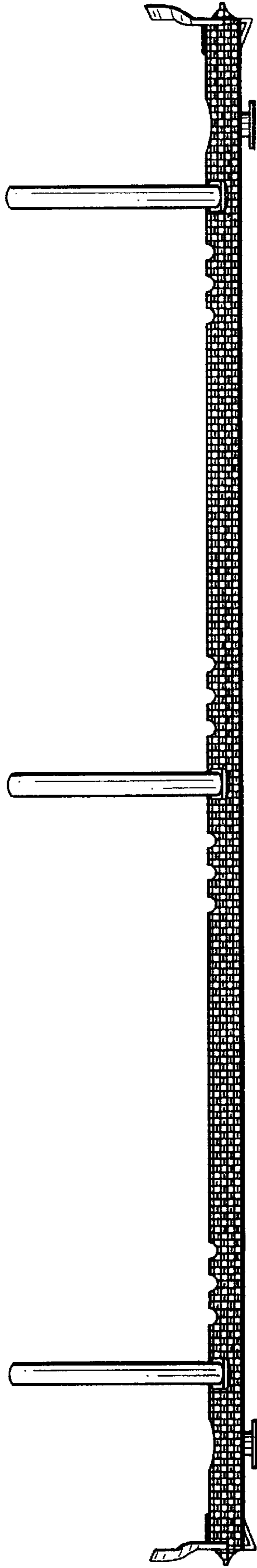

FIG. 15

