



US00D423043S

United States Patent [19]

Ishigami et al.

[11] Patent Number: **Des. 423,043**

[45] Date of Patent: **** Apr. 18, 2000**

[54] **INK CARTRIDGE**

[75] Inventors: **Michifumi Ishigami**, Nagoya;
Nobuyuki Iwai, Chita-gun, both of
Japan

[73] Assignee: **Brother Kogyo Kabushiki Kaisha**,
Nagoya, Japan

[**] Term: **14 Years**

[21] Appl. No.: **29/099,074**

[22] Filed: **Jan. 13, 1999**

[30] **Foreign Application Priority Data**

Jul. 24, 1998 [JP] Japan 10-21333

[51] **LOC (6) Cl.** **18-02**

[52] **U.S. Cl.** **D18/56; 347/86**

[58] **Field of Search** D18/56; 347/86,
347/87, 42, 130

[56] **References Cited**

U.S. PATENT DOCUMENTS

D. 289,765	5/1987	Eto et al.	D18/56
D. 290,705	7/1987	Yomo	D18/56
D. 296,787	7/1988	Hidaka et al.	D18/56
D. 313,426	1/1991	Berriman et al.	D18/56
D. 338,912	8/1993	Miyamoto	D18/56

D. 341,156	11/1993	Smith	D18/56
D. 348,688	7/1994	Ujita	D18/56
D. 353,156	12/1994	Kaplinsky et al.	D18/56
D. 357,274	4/1995	Sato	D18/56
D. 375,975	11/1996	Koizumi et al.	D18/56
D. 381,360	7/1997	Kawai et al.	D18/56
4,499,480	2/1985	Takatori et al.	347/42
4,703,334	10/1987	Mochimaru et al.	347/130
4,855,762	8/1989	Suzuki	347/86
5,314,257	5/1994	Cheng	D18/56
5,365,645	11/1994	Walker et al.	347/42
5,380,106	1/1995	West	D18/56
5,469,199	11/1995	Allen et al.	347/42

Primary Examiner—Cathy Anne MacCormac
Attorney, Agent, or Firm—Oliff & Berridge, PLC

[57] CLAIM

The ornamental design for an ink cartridge, as shown and described.

DESCRIPTION

FIG. 1 is a top plan view of an ink cartridge;
FIG. 2 is a front view of the ink cartridge;
FIG. 3 is a left side view of the ink cartridge;
FIG. 4 is a right side view of the ink cartridge;
FIG. 5 is a bottom plan view of the ink cartridge;
FIG. 6 is a rear view of the ink cartridge; and,
FIG. 7 is a perspective view of the ink cartridge.

1 Claim, 3 Drawing Sheets

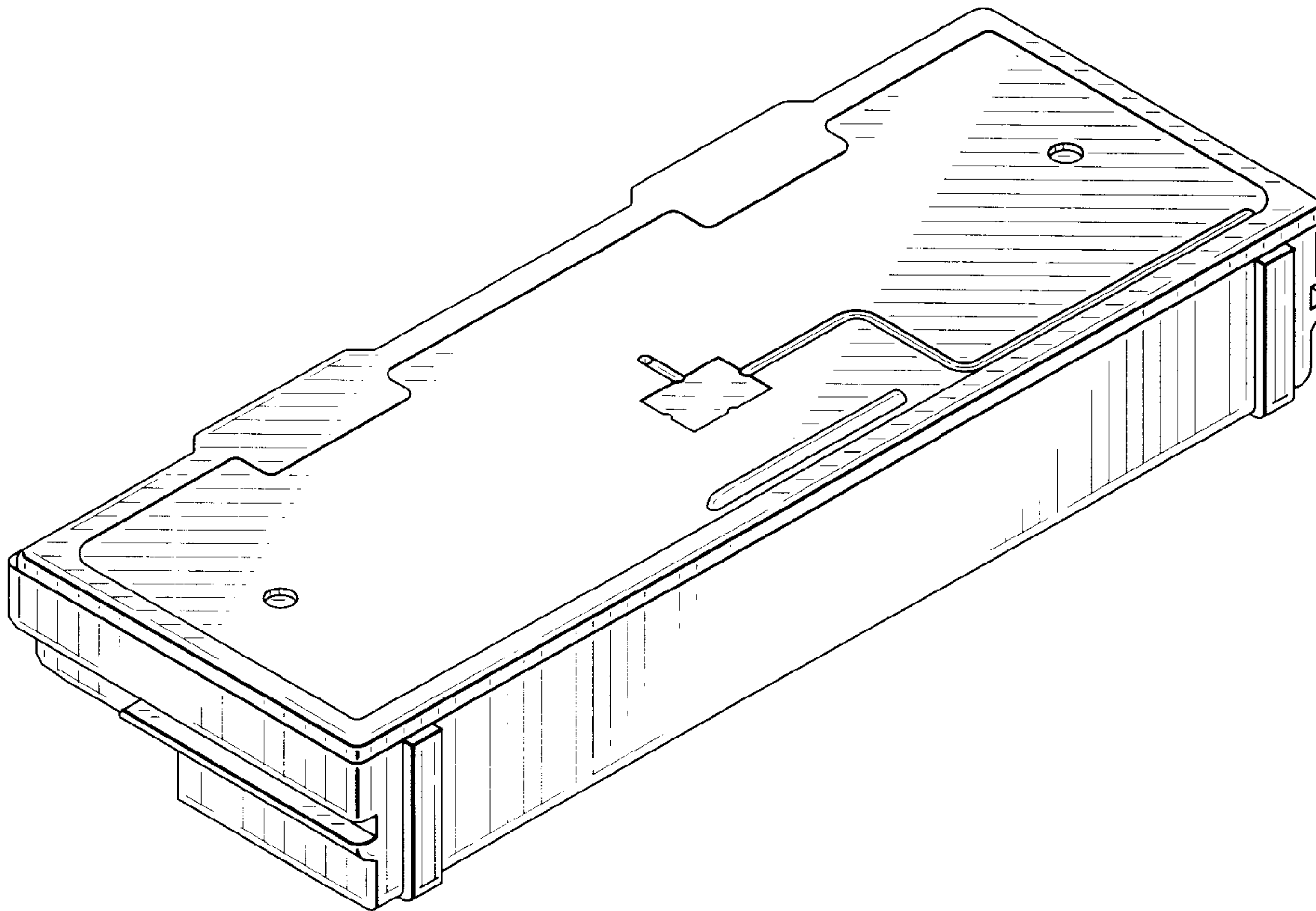

FIG. 1

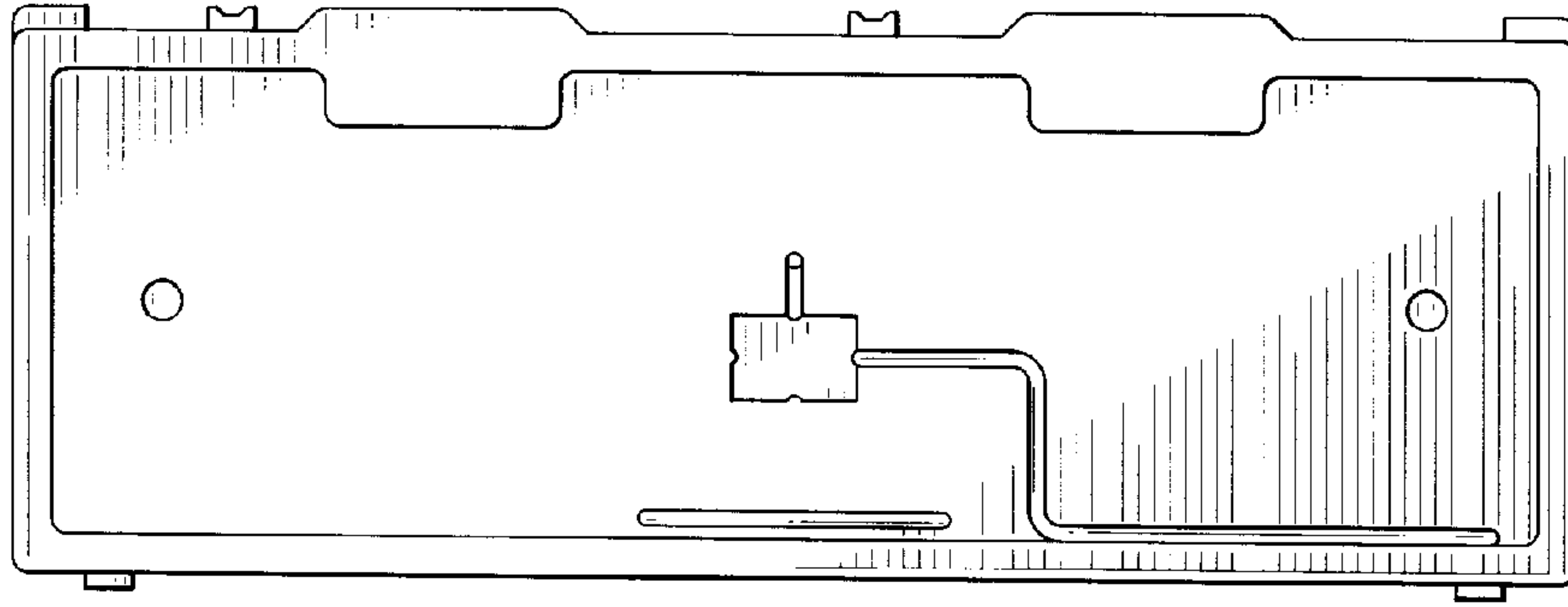

FIG. 2

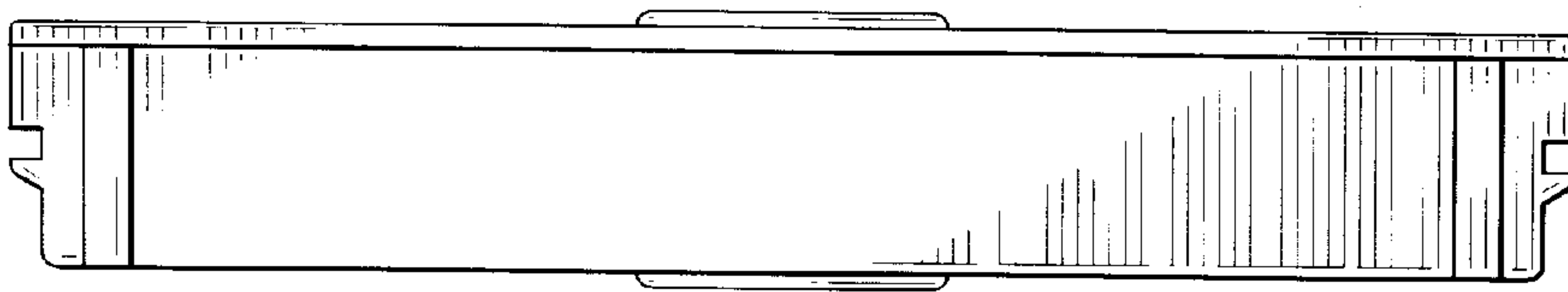

FIG. 3

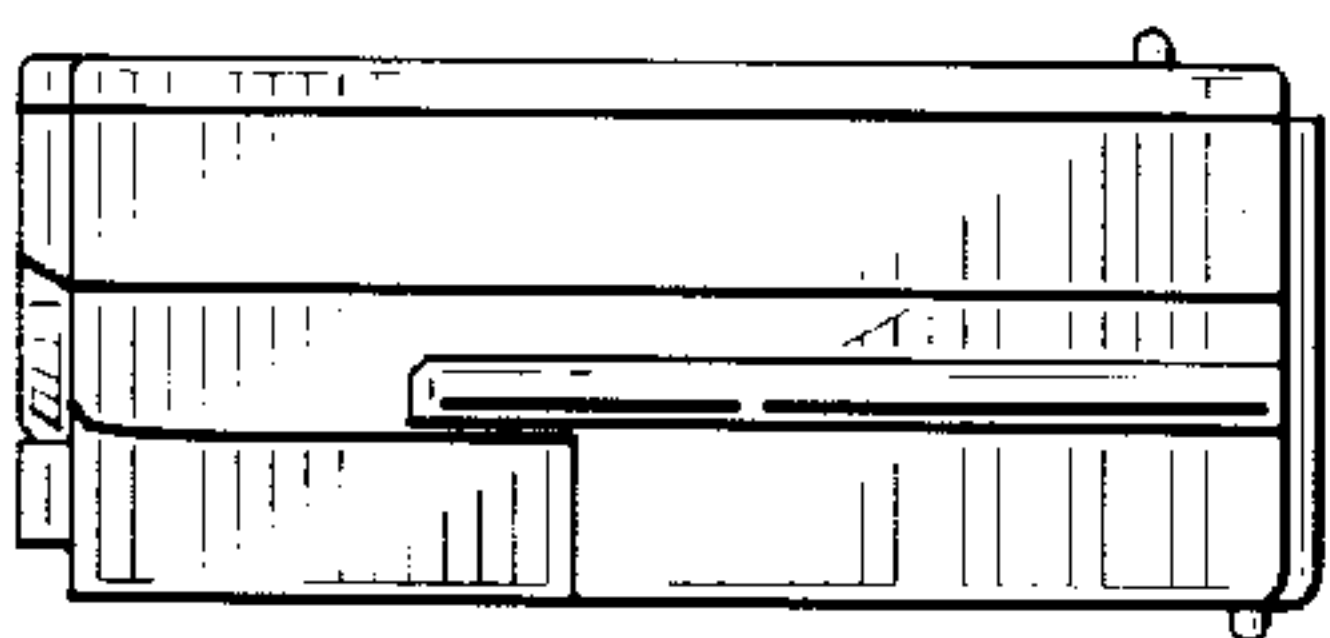

FIG. 4

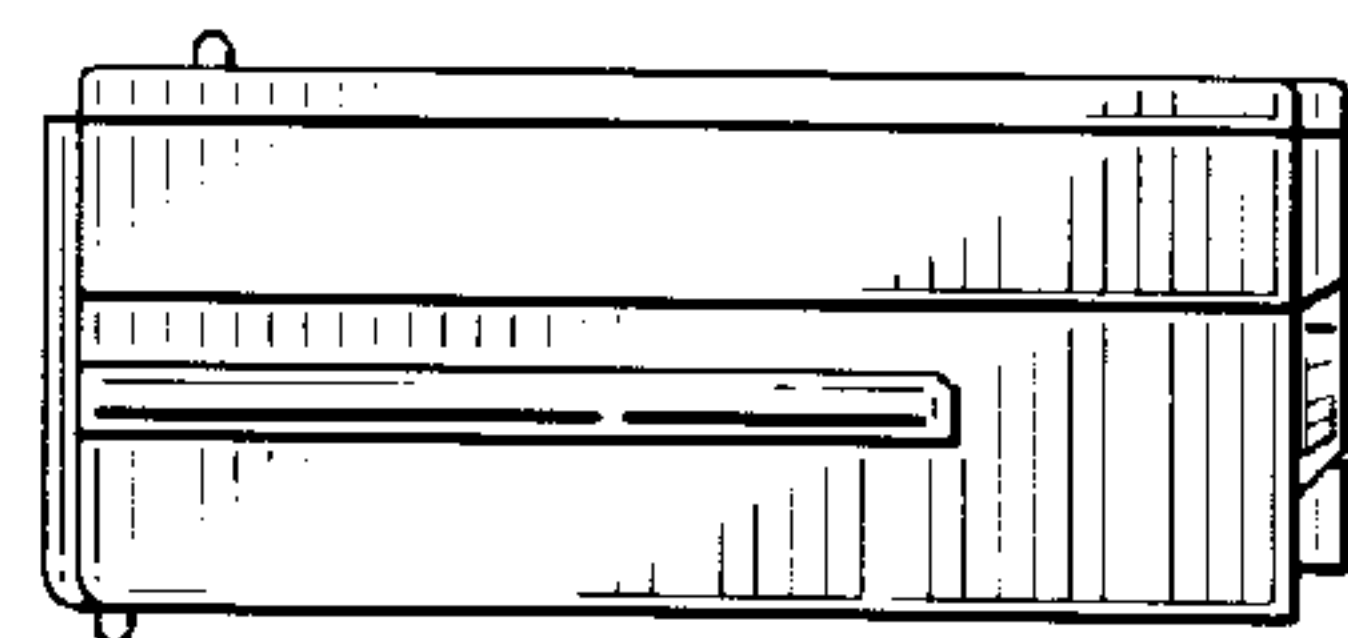

FIG. 5

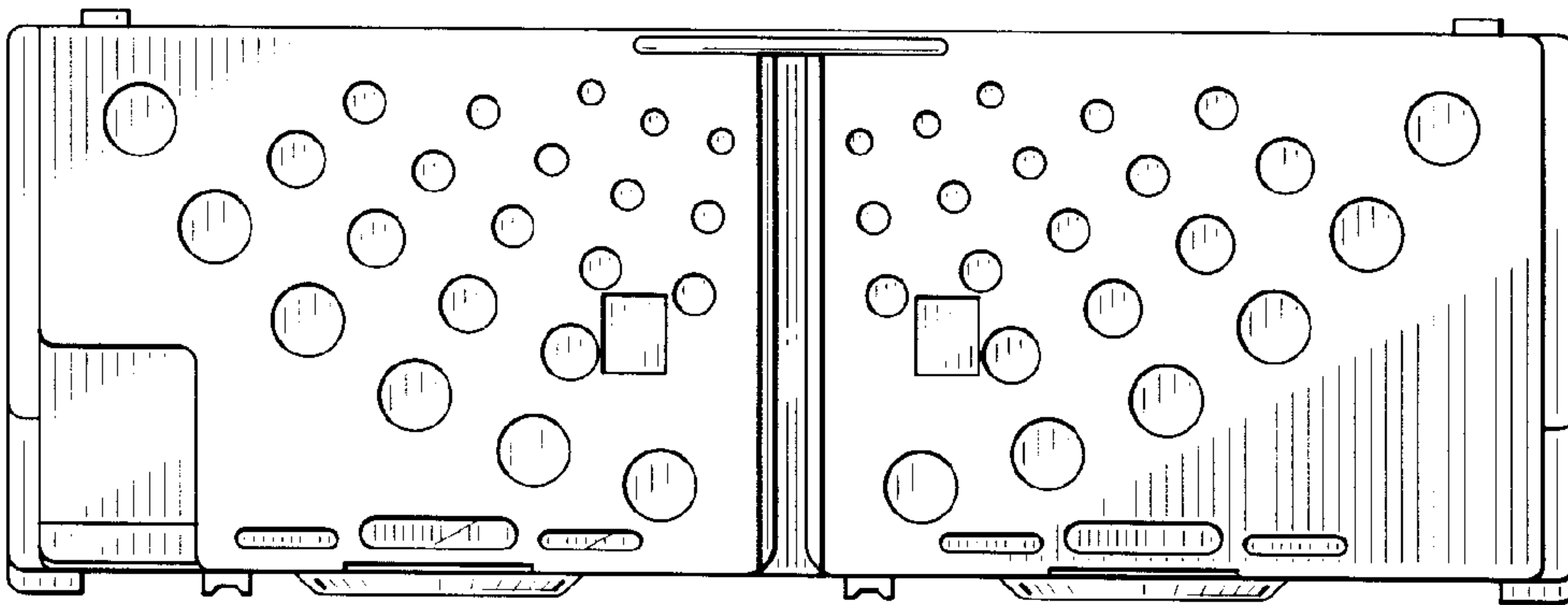

FIG. 6

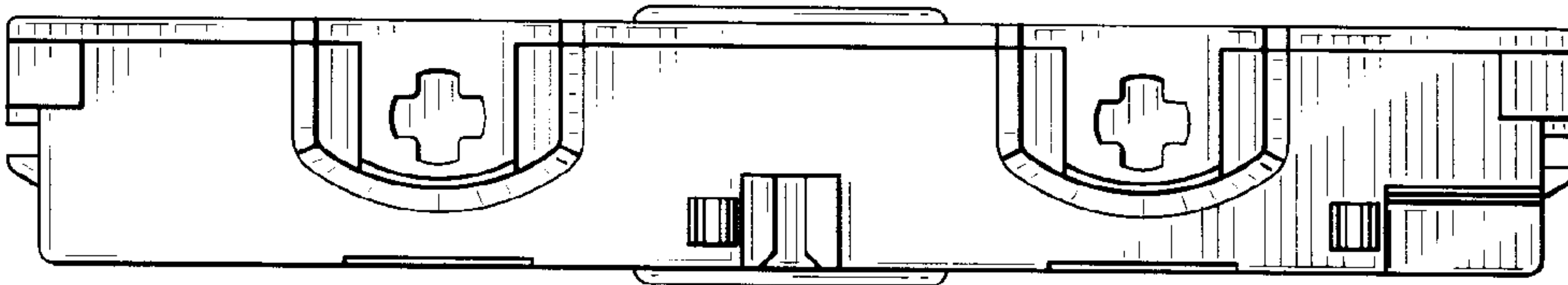

FIG. 7

