



US00D423040S

United States Patent [19]

Ohta et al.

[11] Patent Number: **Des. 423,040**

[45] Date of Patent: **** Apr. 18, 2000**

[54] **COPIER**

[75] Inventors: **Kenji Ohta**, Osaka-fu; **Takaaki Kuwahara**; **Keiichi Takao**, both of Nara-ken, all of Japan

[73] Assignee: **Sharp Kabushiki Kaisha**, Osaka, Japan

[**] Term: **14 Years**

[21] Appl. No.: **29/091,272**

[22] Filed: **Jul. 27, 1998**

[30] Foreign Application Priority Data

Jan. 26, 1998 [JP] Japan 10-1968

[51] **LOC (6) Cl.** **16-03**

[52] **U.S. Cl.** **D18/36**

[58] **Field of Search** D18/36-39, 54, D18/55; D14/118; 399/1-7, 16, 130

[56] References Cited

U.S. PATENT DOCUMENTS

D. 329,870 9/1992 Hanasaki et al. D18/55

D. 334,205	3/1993	Ratzlaff	D18/39
D. 339,151	9/1993	Ratzlaff	D18/36
D. 339,152	9/1993	Hirose et al.	D18/39
D. 354,076	1/1995	Fukuda et al.	D18/36
D. 388,821	1/1998	Kenmochi	D18/53
D. 404,419	1/1999	Kusanagi	D18/39

Primary Examiner—Caron D. Veynar
Attorney, Agent, or Firm—Nixon & Vanderhye

[57] CLAIM

The ornamental design for a copier, as shown and described.

DESCRIPTION

FIG. 1 is a top, front and right side perspective view of a copier according to our design;
FIG. 2 is a top plan view thereof;
FIG. 3 is a front elevational view thereof;
FIG. 4 is a right side elevational view thereof;
FIG. 5 is a rear elevational view thereof;
FIG. 6 is a left side elevational view thereof; and,
FIG. 7 is a bottom plan view thereof.

1 Claim, 7 Drawing Sheets

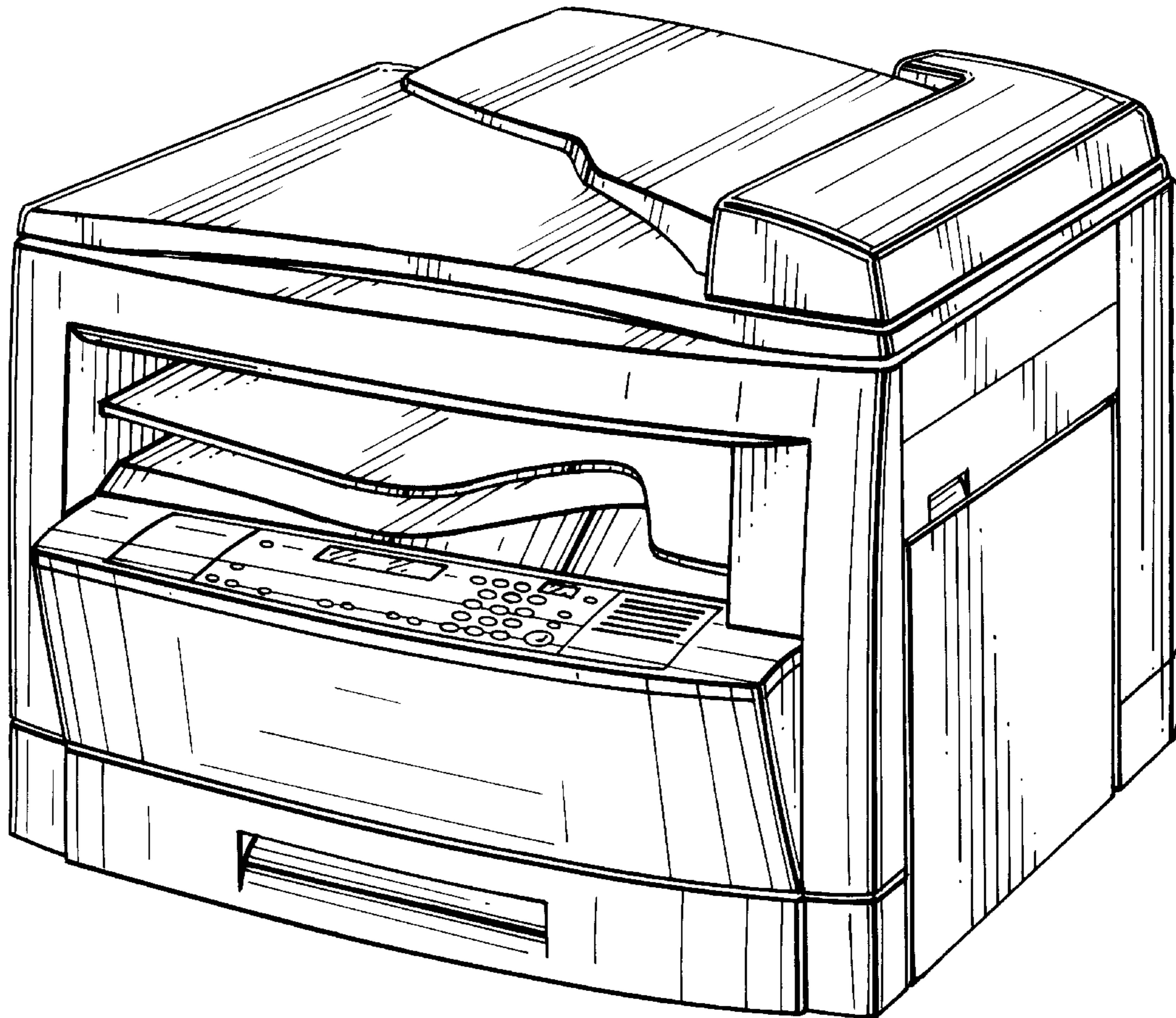

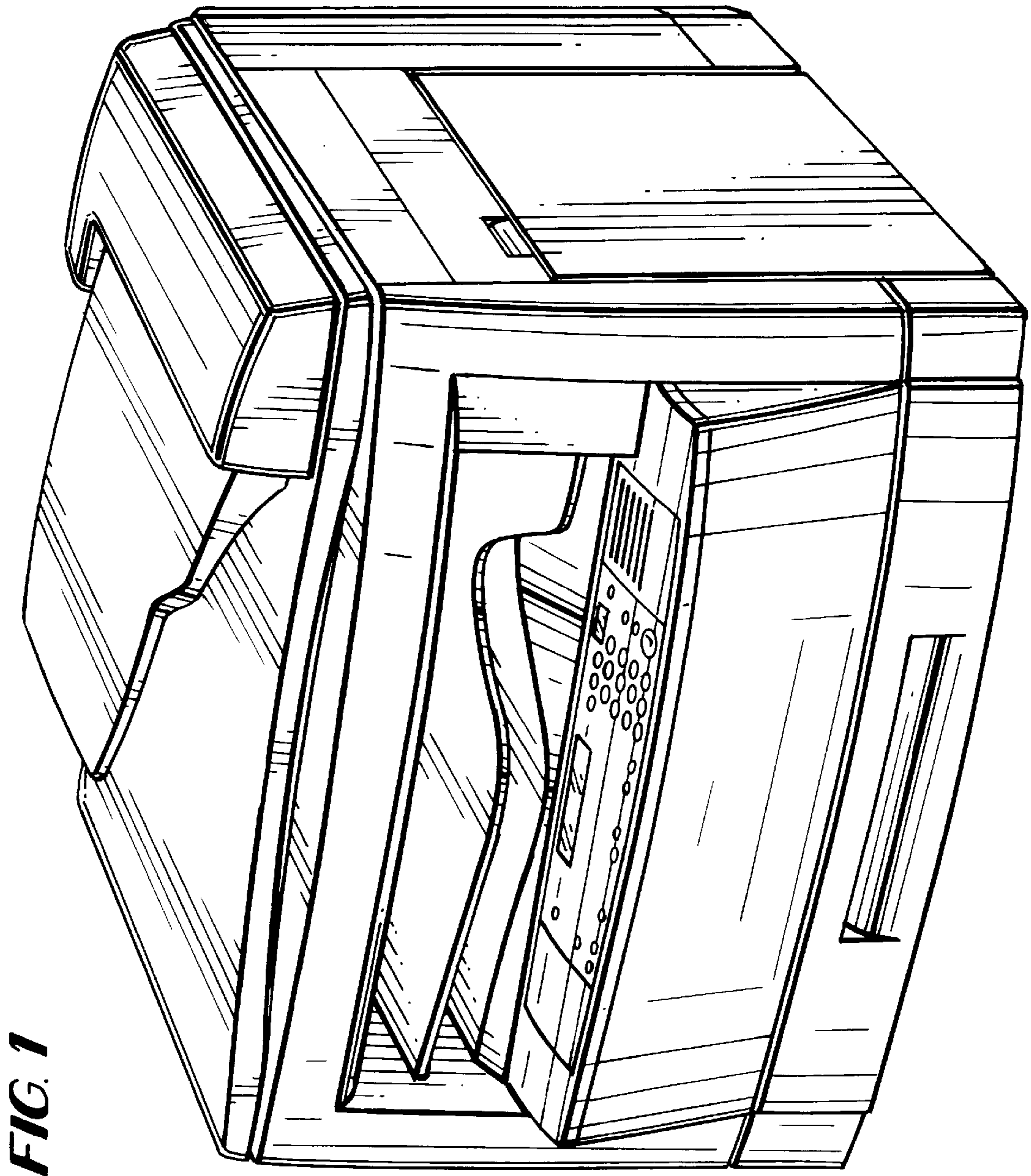

FIG. 1

FIG. 2

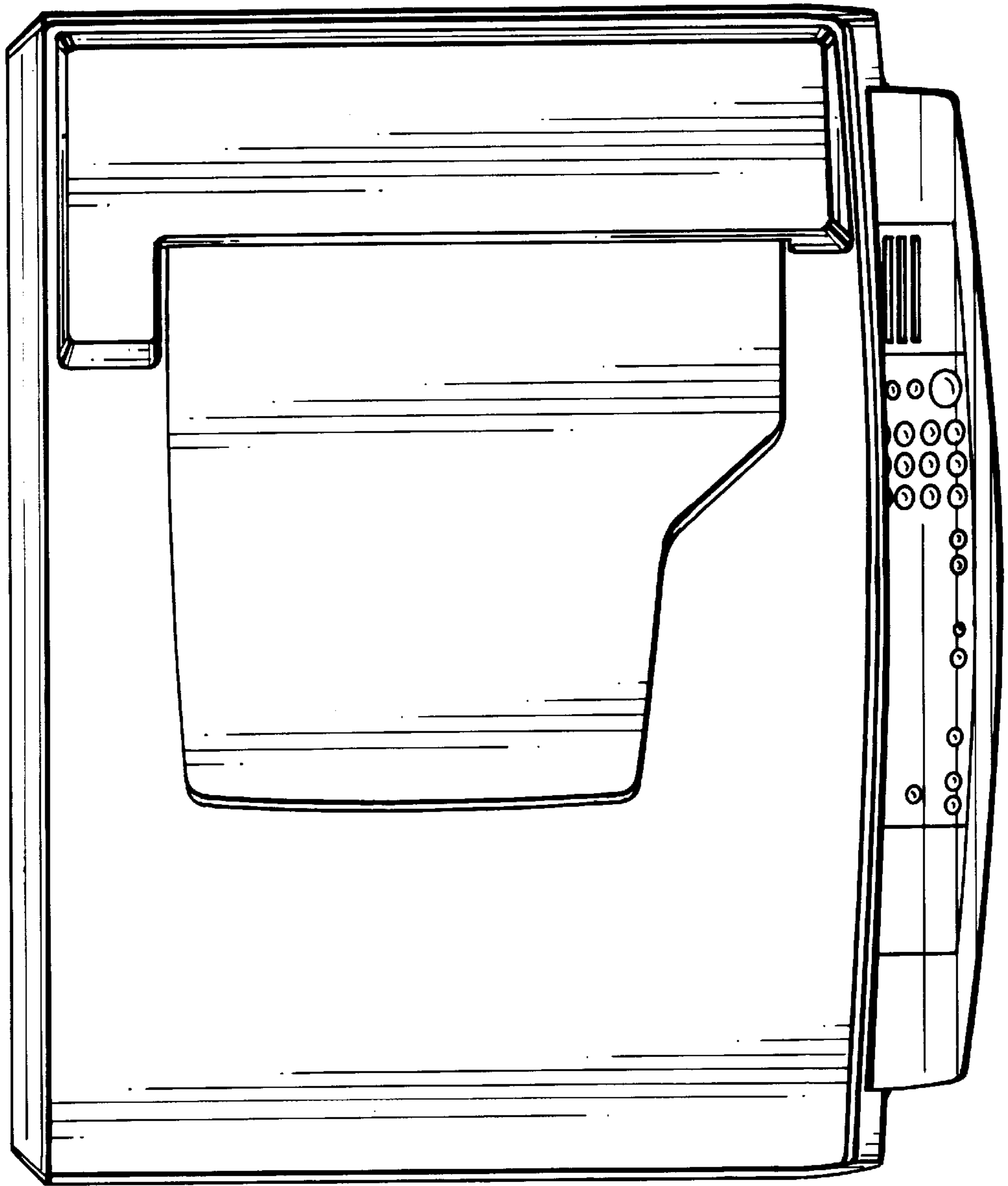

FIG. 3

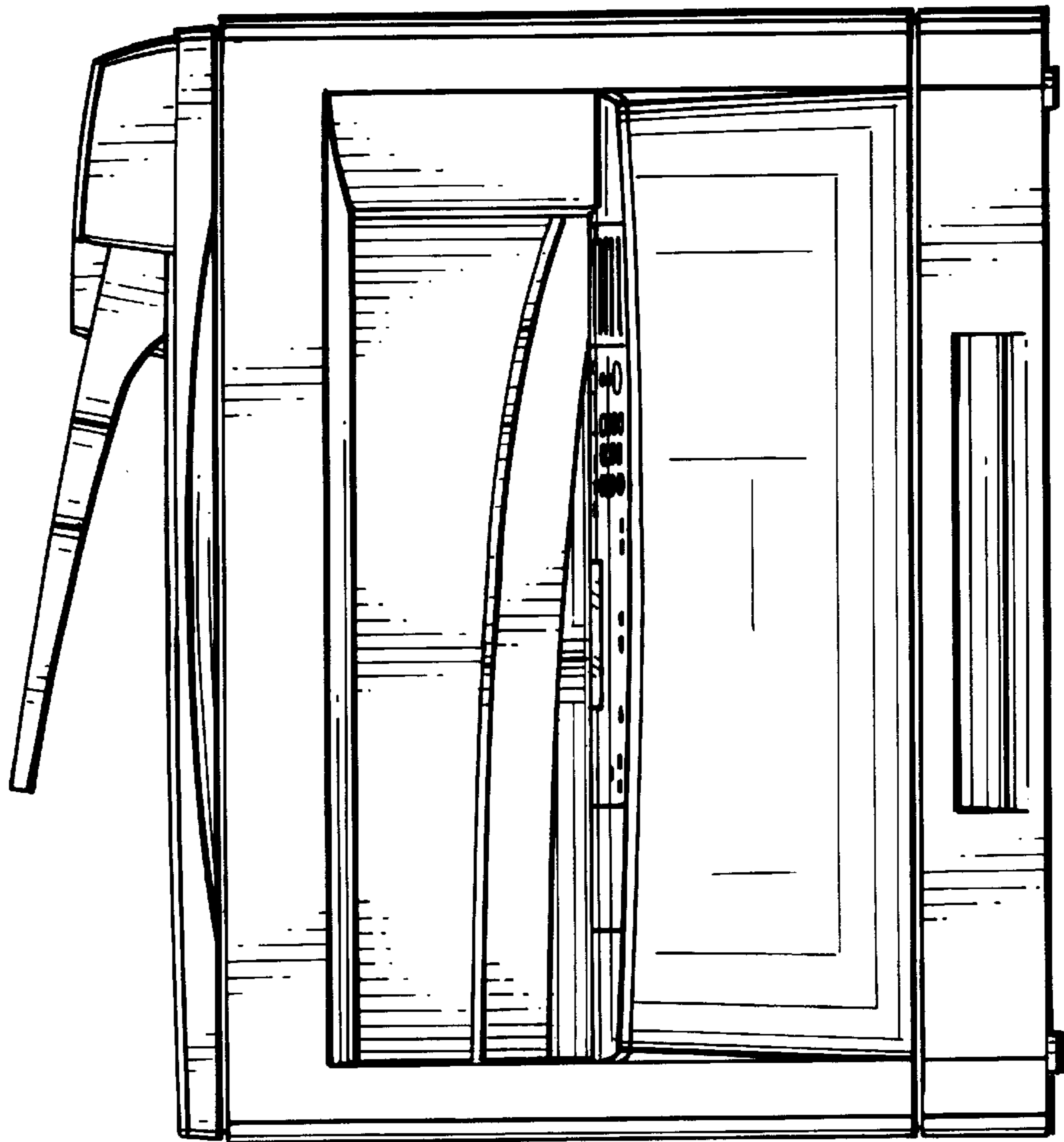

FIG. 4

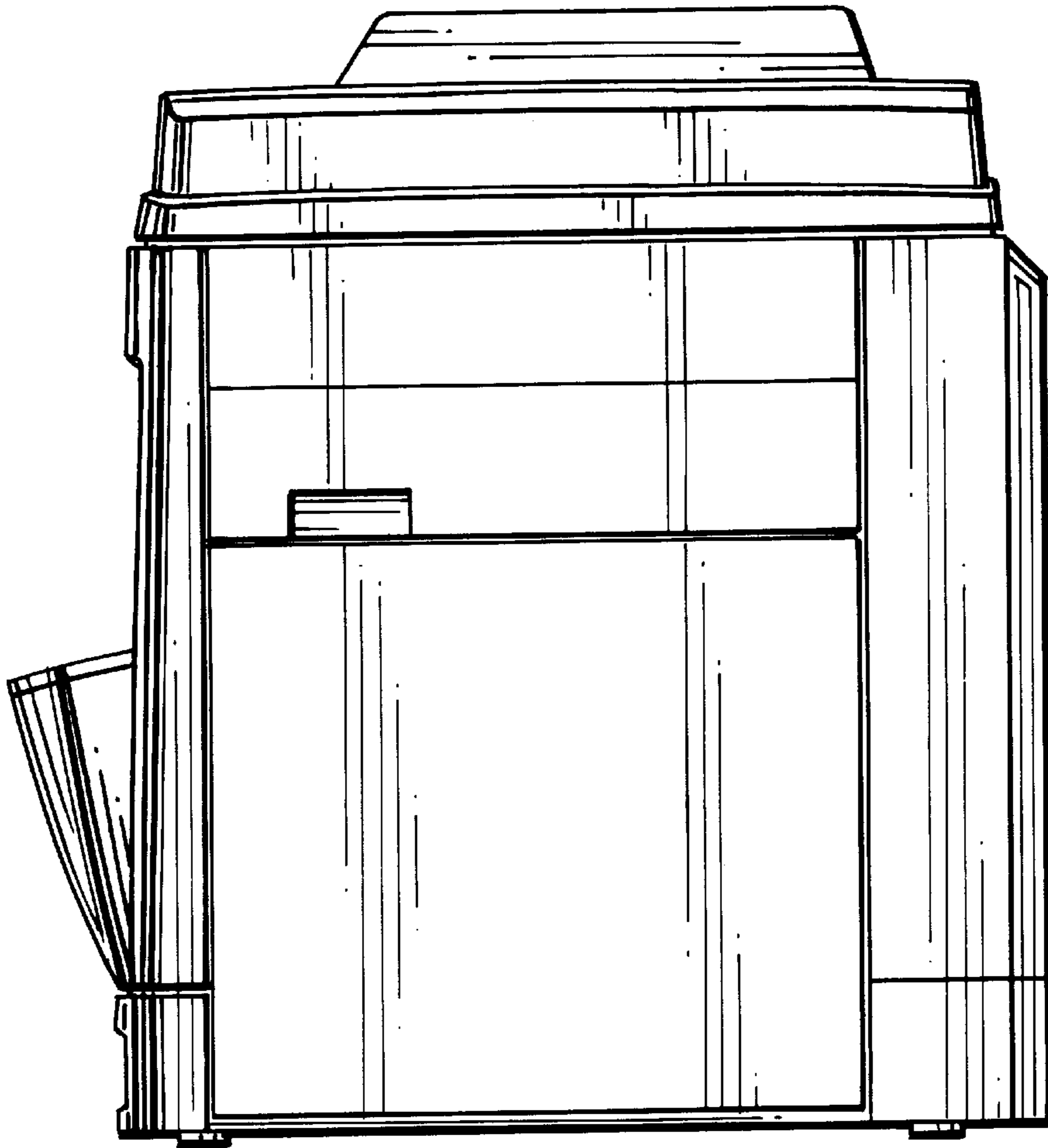

FIG. 5

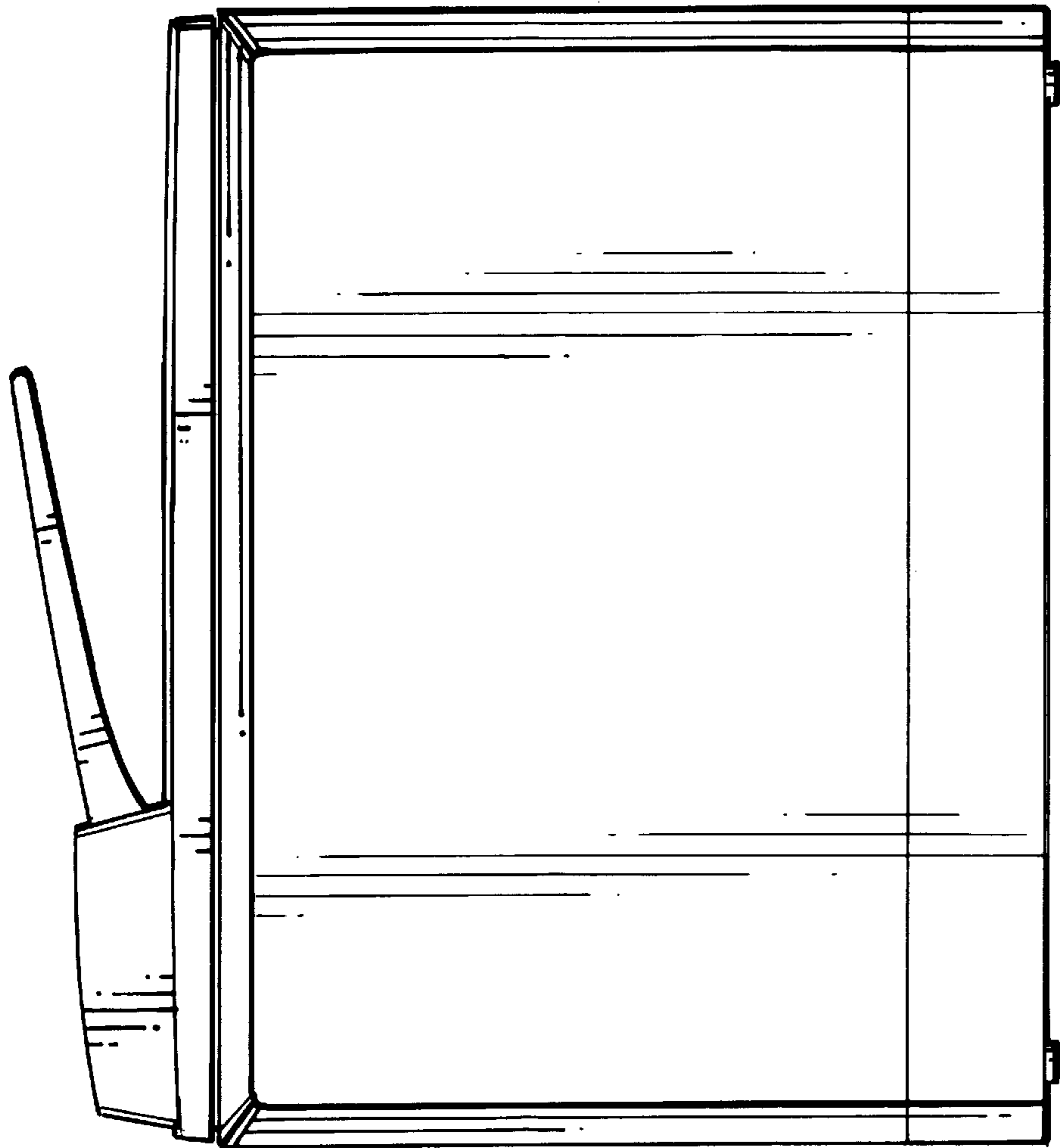

FIG. 6

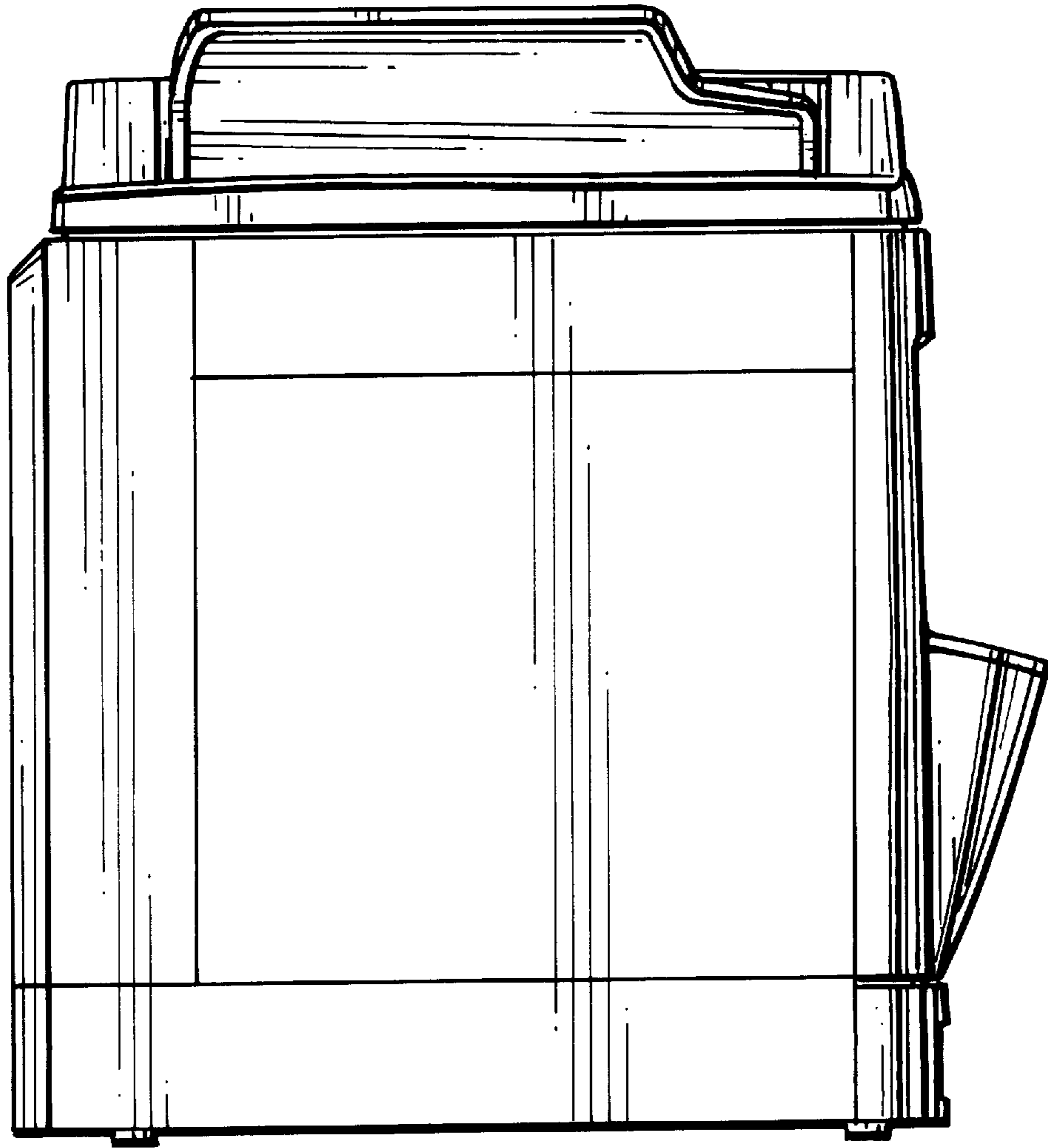

FIG. 7

