



US00D423007S

United States Patent [19] Shintani

[11] Patent Number: **Des. 423,007**

[45] Date of Patent: **** Apr. 18, 2000**

[54] **COMBINED DISC RECORDER AND PLAYER**

[75] Inventor: **Eiji Shintani**, Tokyo, Japan

[73] Assignee: **Sony Corporation**, Japan

[**] Term: **14 Years**

[21] Appl. No.: **29/098,526**

[22] Filed: **Dec. 30, 1998**

[51] **LOC (6) Cl.** **14-01**

[52] **U.S. Cl.** **D14/168; D14/156**

[58] **Field of Search** D14/135, 136,
D14/156, 160-168, 188, 197-198; 369/75.1,
75.2, 77.1, 77.2; 455/344, 347, 350, 351

[56] **References Cited**

U.S. PATENT DOCUMENTS

D. 310,837	9/1990	Takimoto	D14/156 X
D. 341,832	11/1993	Ito et al.	D14/198
D. 379,625	6/1997	Uchiyama	D14/156
5,177,730	1/1993	Utsugi	369/75.1

OTHER PUBLICATIONS

Catalog "83", p. 108, Sony (Jul. 1996).
Catalog "84", p. 119, Sony (Nov. 1996).
Catalog "86", p. 341, Sony (Jul. 1997).
Catalog "87", p. 125, Sony (Nov. 1997).

Primary Examiner—Nanda Bondade
Attorney, Agent, or Firm—Rader, Fishman & Grauer

[57] **CLAIM**

The ornamental design for a combined disc recorder and player, as shown and described.

DESCRIPTION

FIG. 1 is a perspective view of a combined disc recorder and player showing my new design;
FIG. 2 is a front elevational view thereof;
FIG. 3 is a rear elevational view thereof;
FIG. 4 is a top plan view thereof;
FIG. 5 is a bottom plan view thereof;
FIG. 6 is a left side elevational view thereof; and,
FIG. 7 is a right side elevational view thereof.

1 Claim, 4 Drawing Sheets

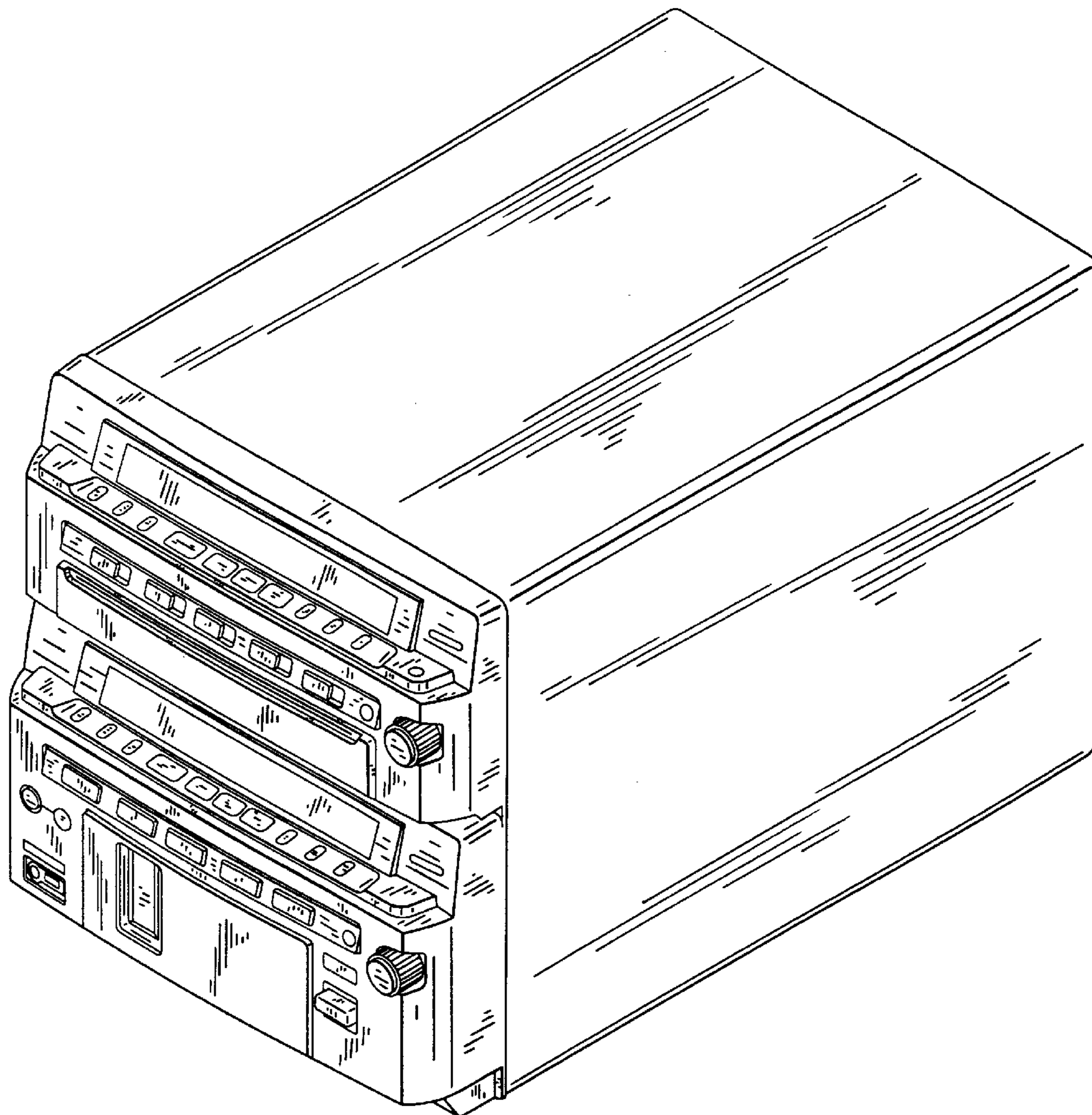

FIG. 1

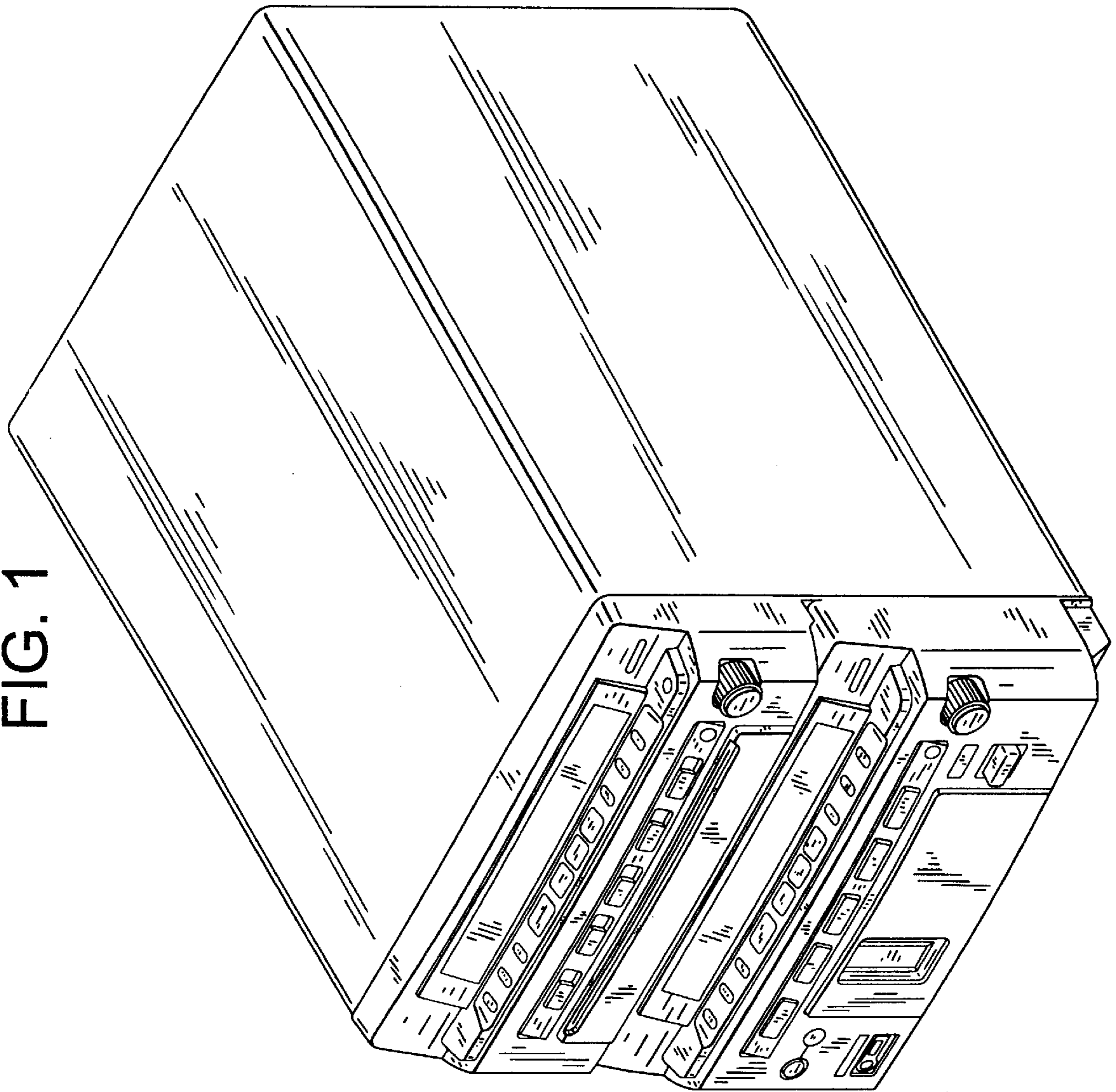

FIG. 3

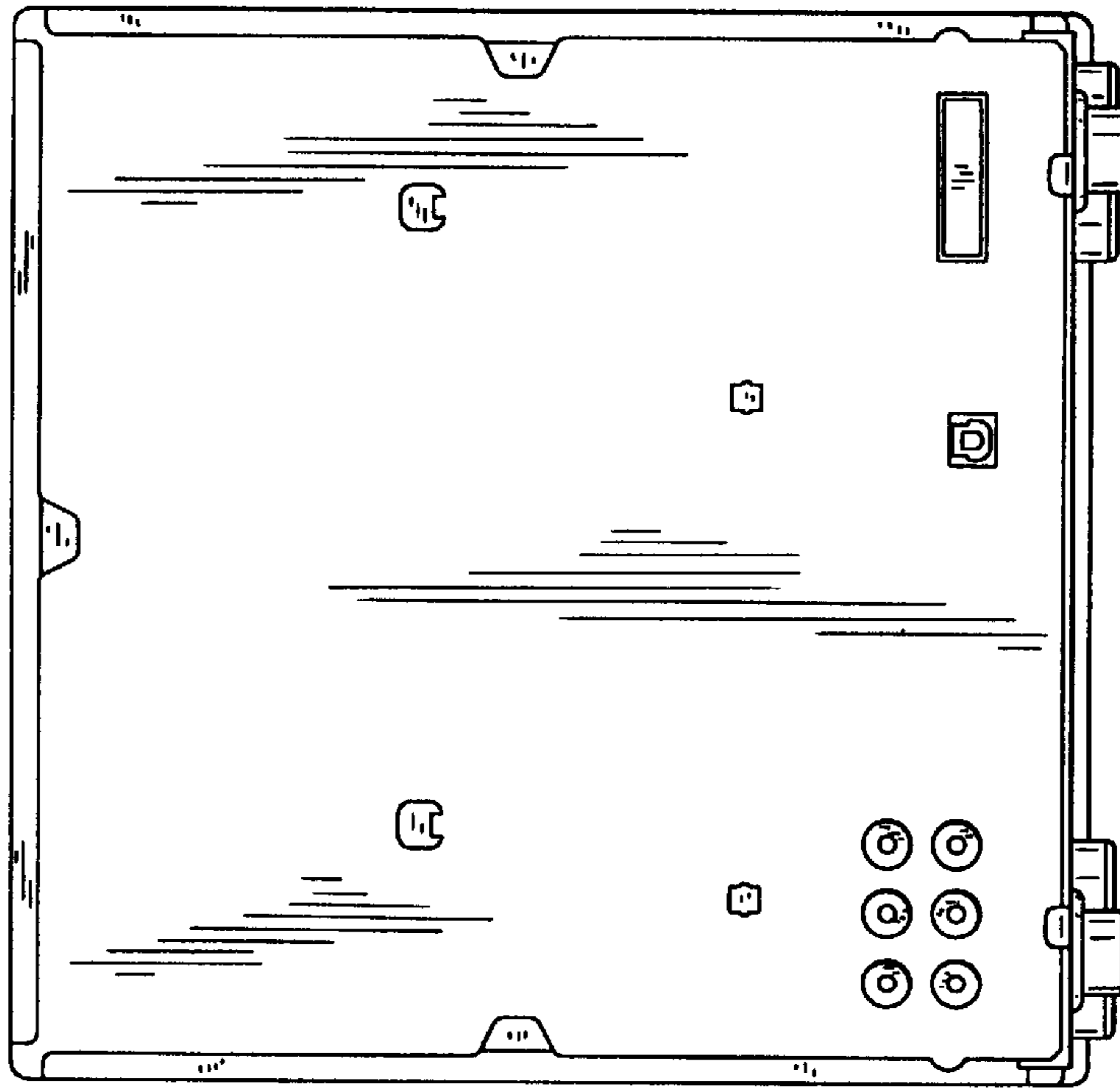

FIG. 2

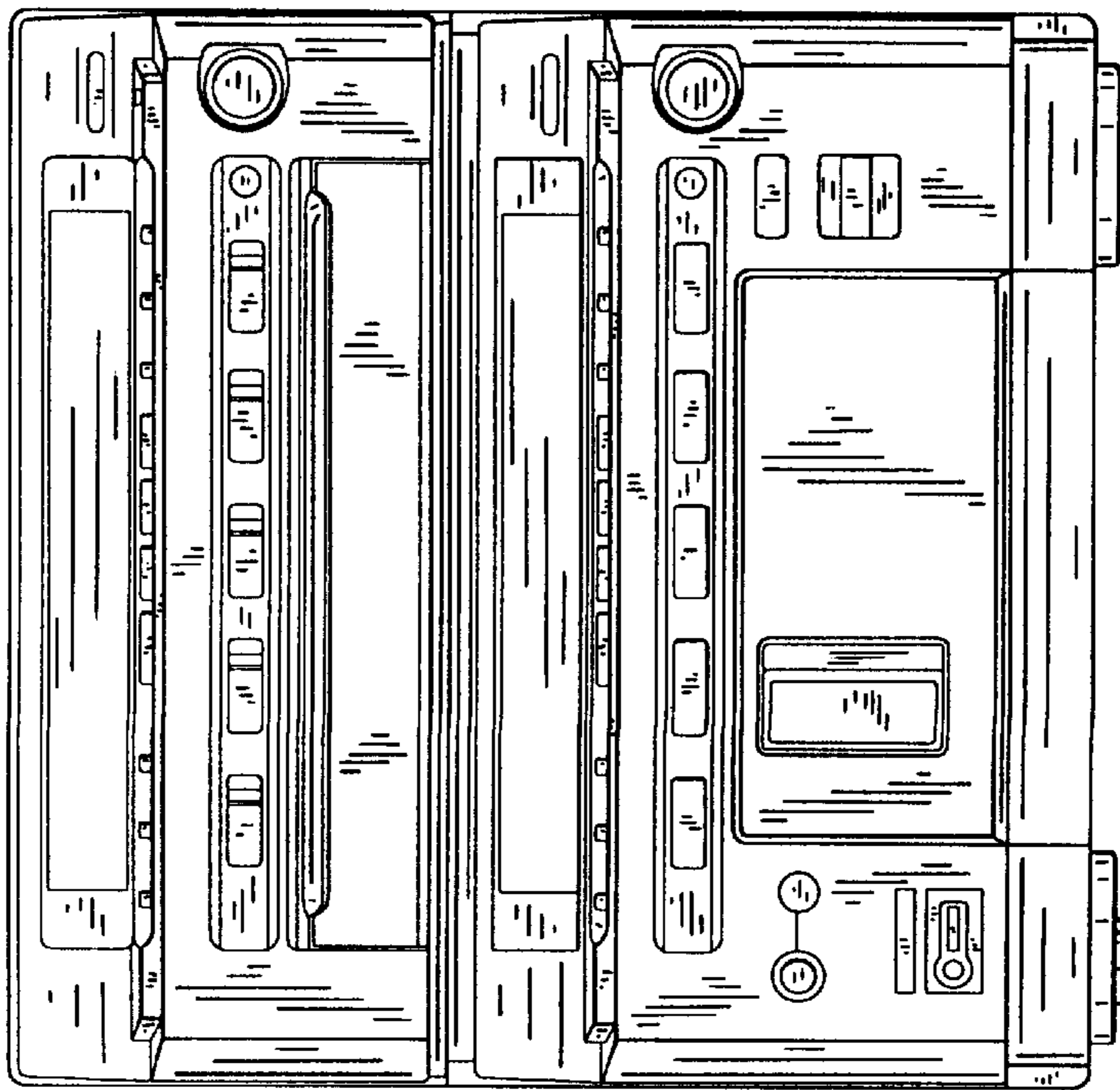

FIG. 5

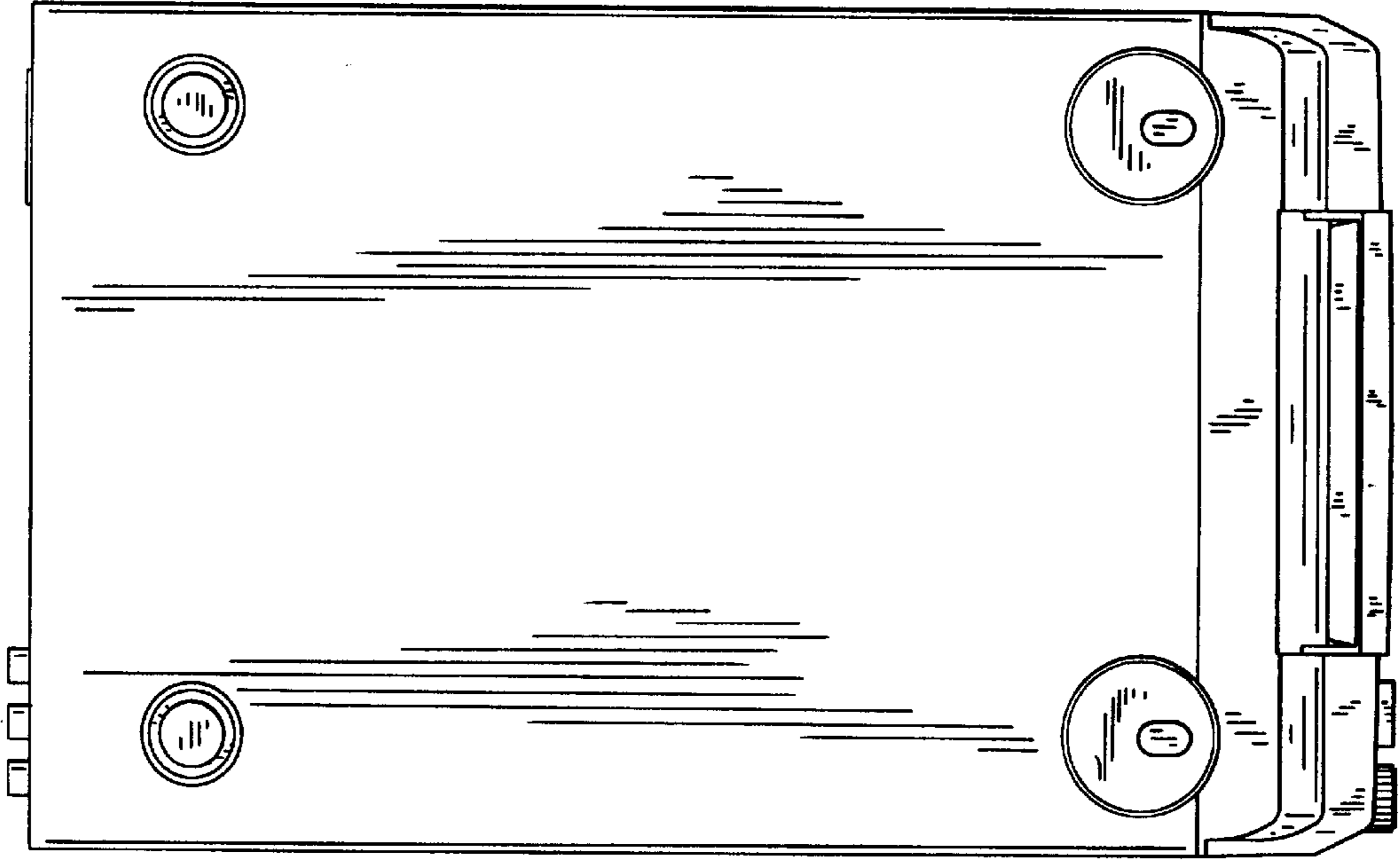

FIG. 4

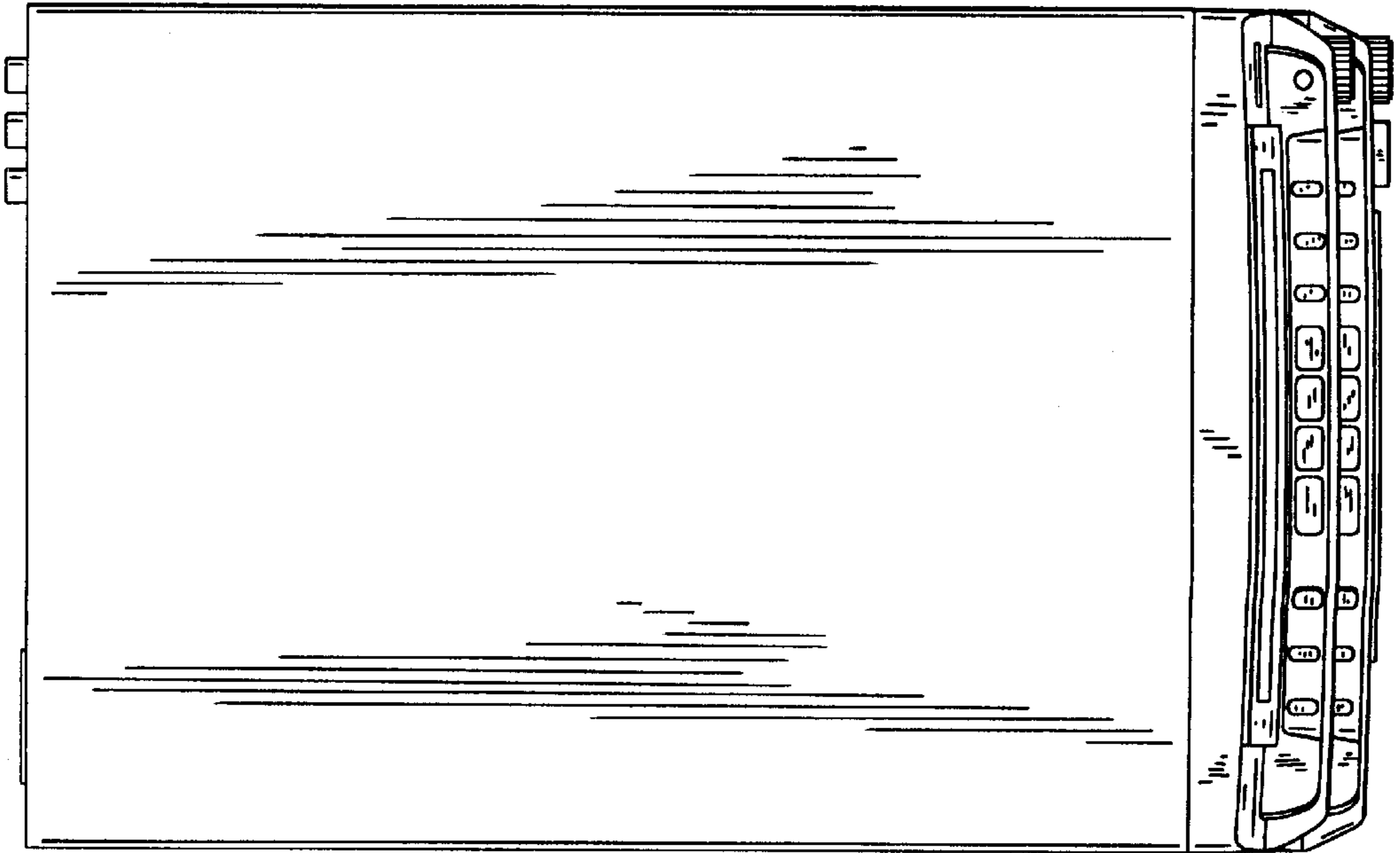

FIG. 6

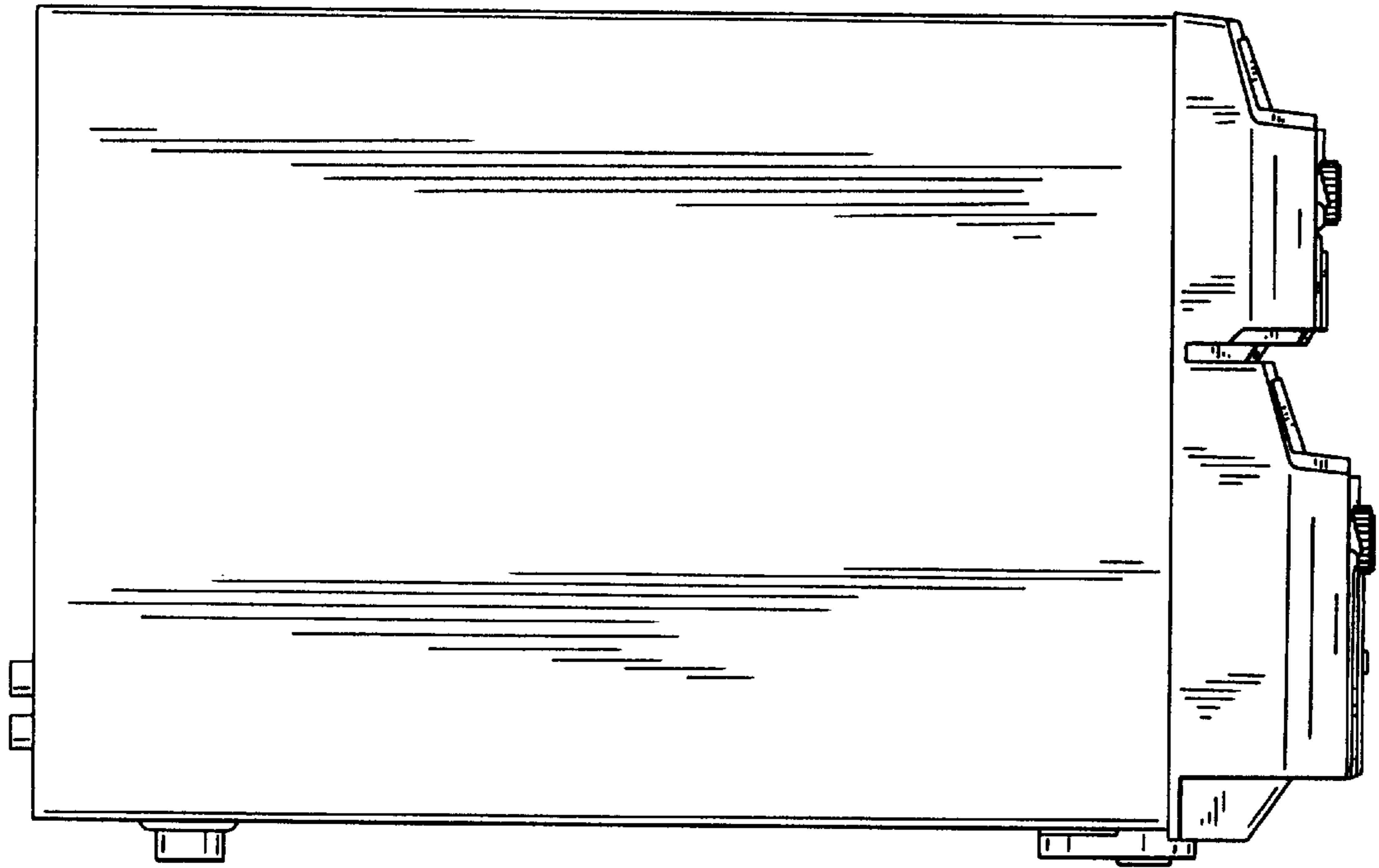

FIG. 7

