



US00D422788S

# United States Patent [19] Carr

[11] **Patent Number: Des. 422,788**

[45] **Date of Patent: \*\* Apr. 18, 2000**

[54] **MULTI-COMPARTMENTAL CONTAINER**

[76] Inventor: **Dennis Carr**, 5986 John Rd., Utica, N.Y. 13502

[\*\*] Term: **14 Years**

[21] Appl. No.: **29/089,960**

[22] Filed: **Jun. 26, 1998**

[51] **LOC (6) Cl. .... 03-01**

[52] **U.S. Cl. .... D3/309; D3/307; D3/308**

[58] **Field of Search .... D3/304, 307, 308, D3/309, 310, 311, 312, 313, 314; 206/203, 540; 220/234, 507, 516, 519**

[56] **References Cited**

**U.S. PATENT DOCUMENTS**

D. 298,079	10/1988	Chatham et al. ....	D3/308
3,625,393	12/1971	Mittel .....	206/203
3,887,103	6/1975	Spooner .....	206/203
4,328,902	5/1982	North .....	220/516
4,895,256	1/1990	Johnston .....	220/516

*Primary Examiner*—Louis S. Zarfes  
*Assistant Examiner*—Monica A. Weingart  
*Attorney, Agent, or Firm*—George R. McGuire

[57] **CLAIM**

The ornamental design for a multi-compartmental container, as shown and described.

**DESCRIPTION**

FIG. 1 is a perspective view of my present invention with dividing walls of the multi-compartmental container being shown in phantom for illustrative purposes only; FIG. 2 is a top plan view thereof; FIG. 3 is a front elevational view thereof, the rear elevation being a mirror image thereof; FIG. 4 is a side elevational view thereof the other side elevation being a mirror image thereof; FIG. 5 is a top plan view thereof, with the handle being shown in a folded position; FIG. 6 is a bottom plan view thereof; and, FIG. 7 is a perspective view thereof with the divider walls omitted therefrom.

**1 Claim, 6 Drawing Sheets**

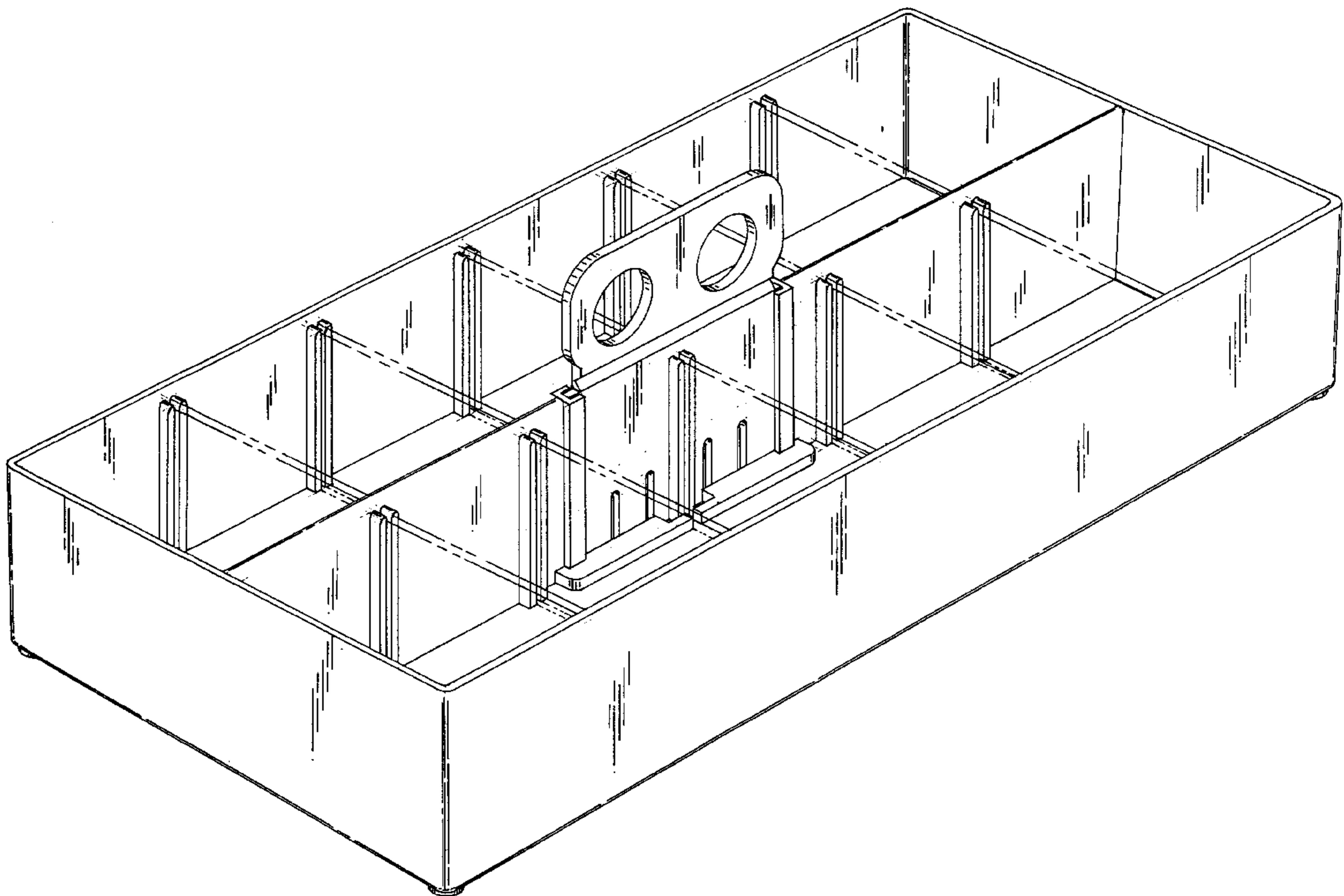

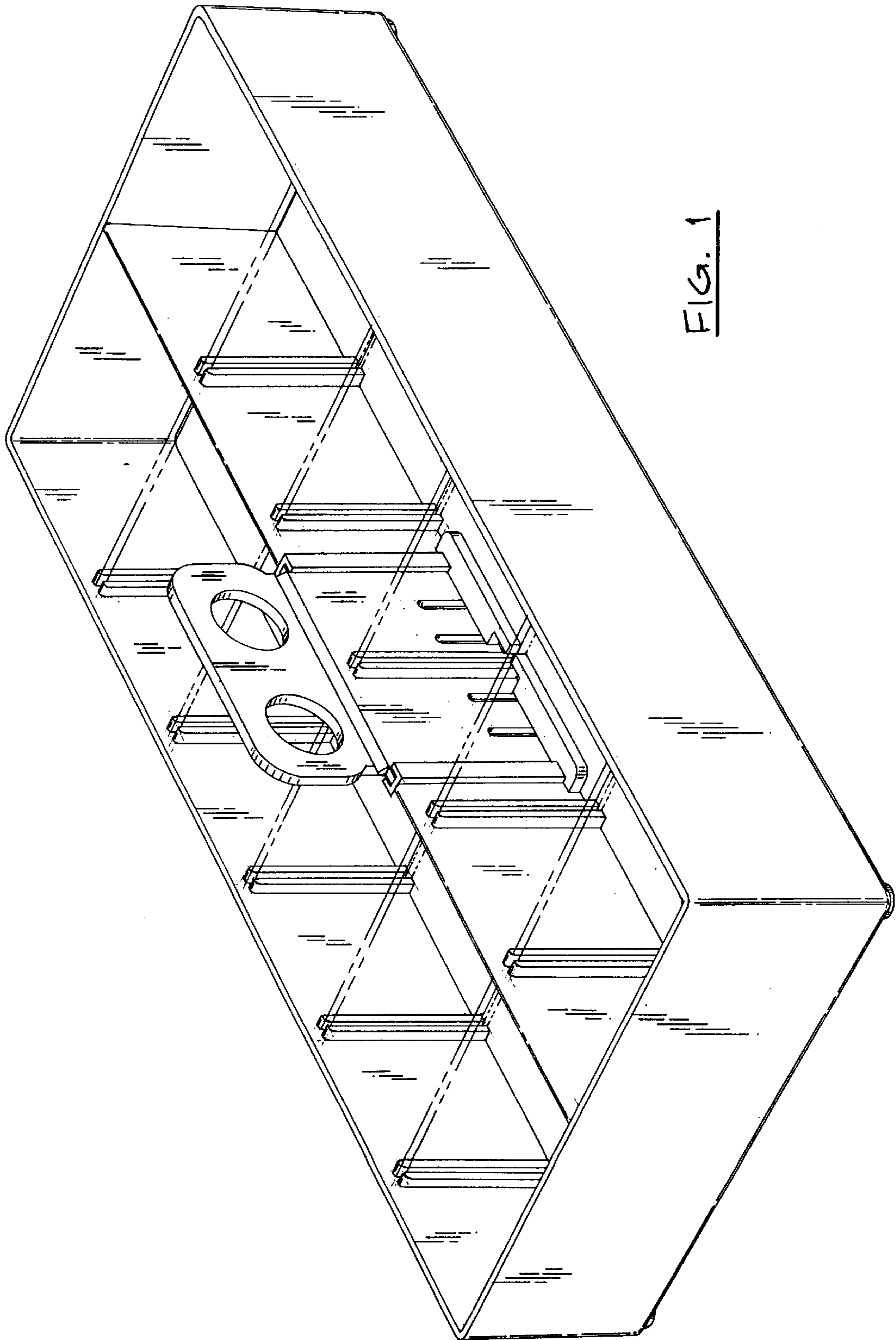

FIG. 1

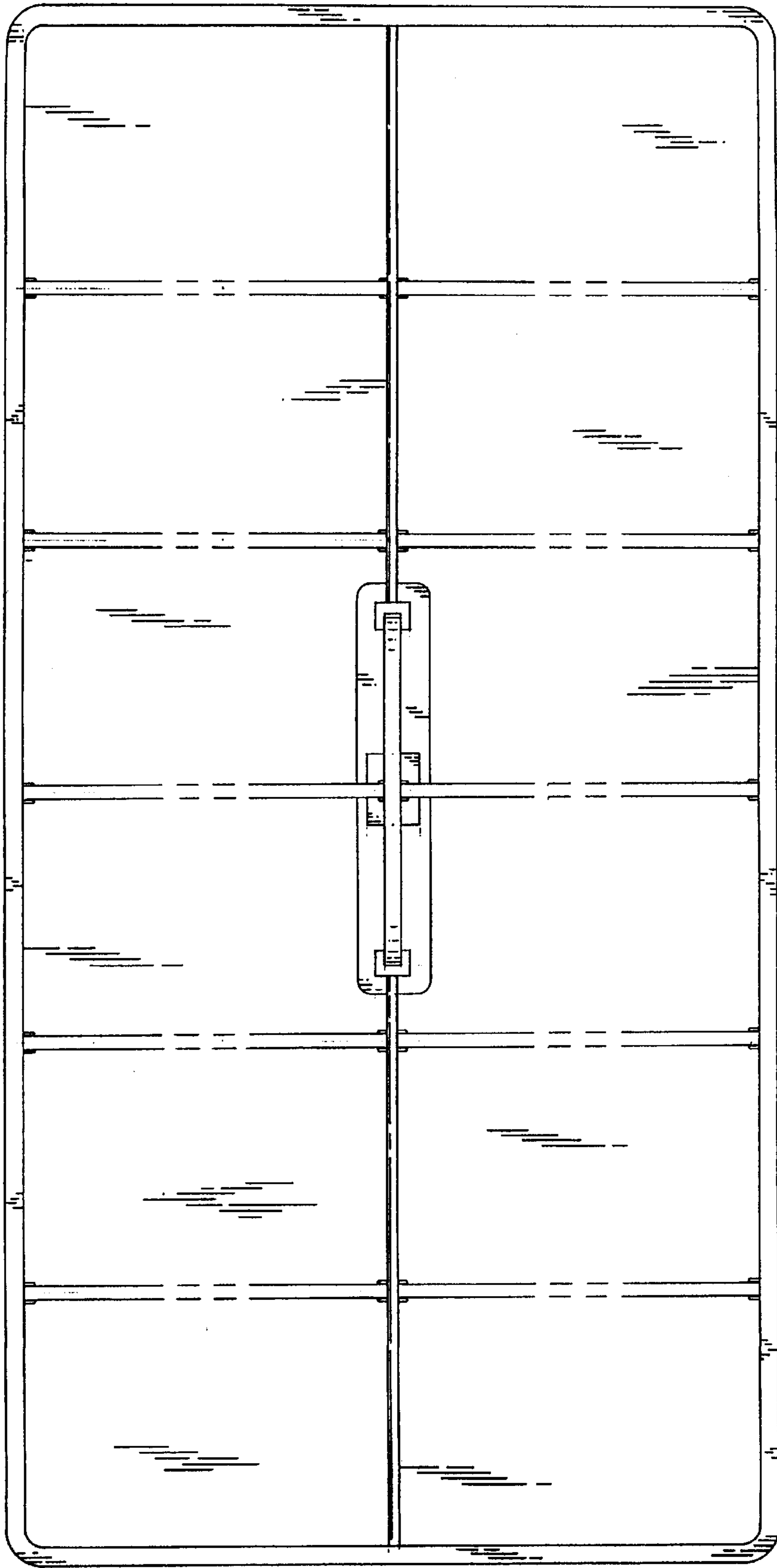

FIG. 2

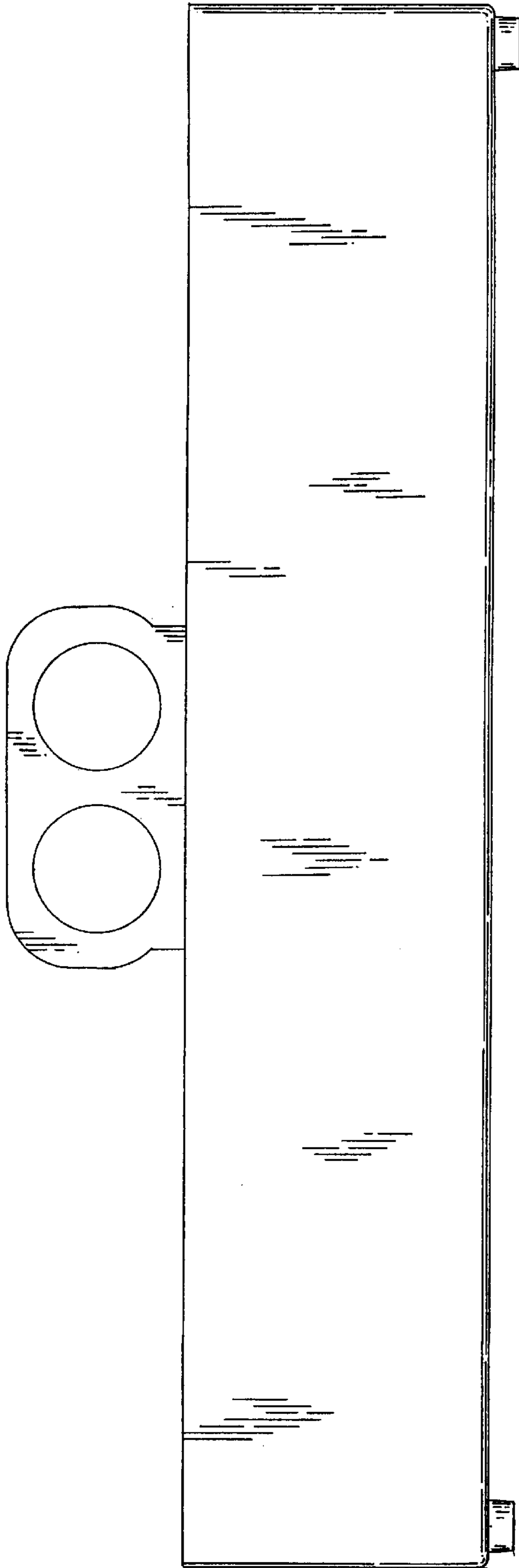

FIG. 3

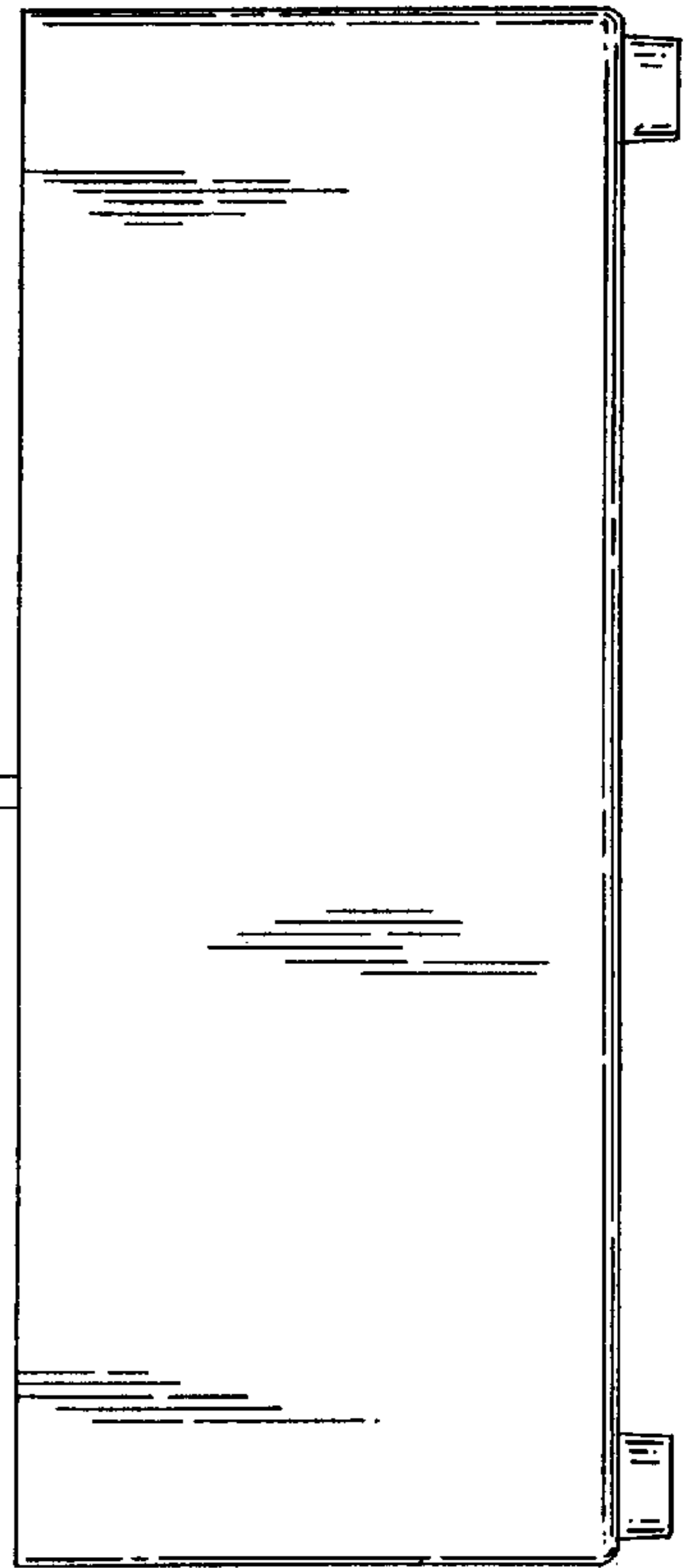

FIG. 4

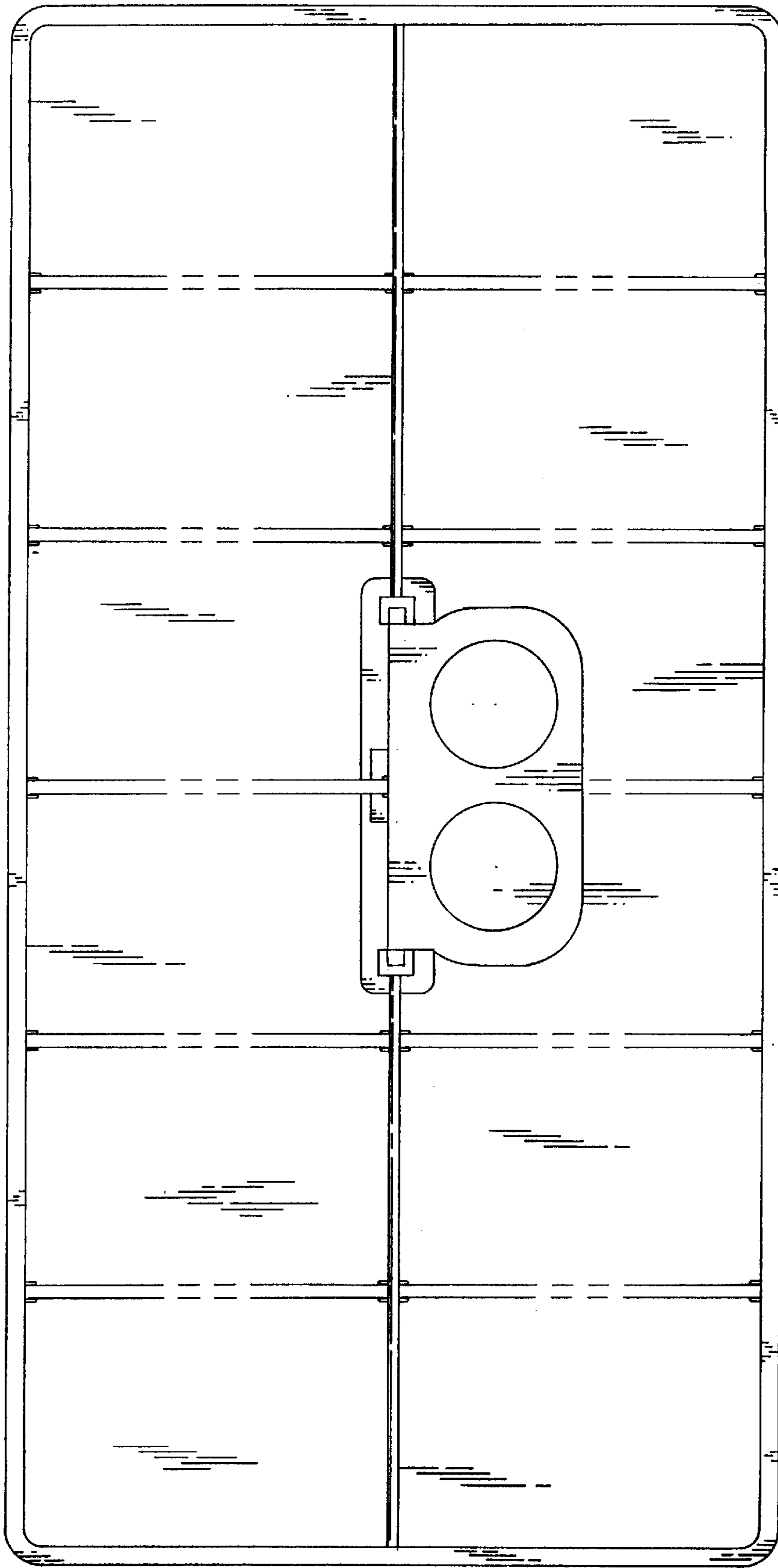

FIG. 5

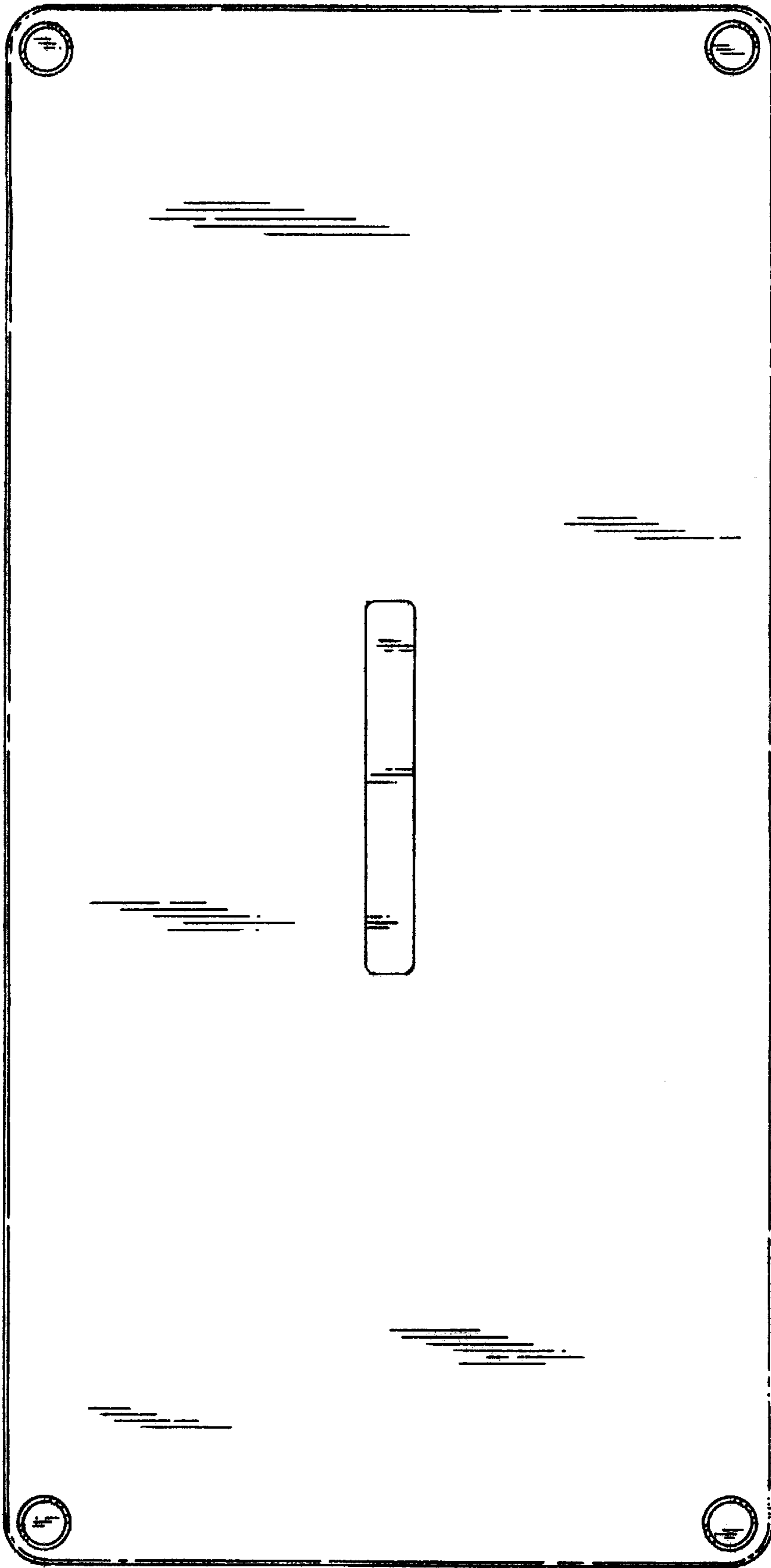

FIG. 6

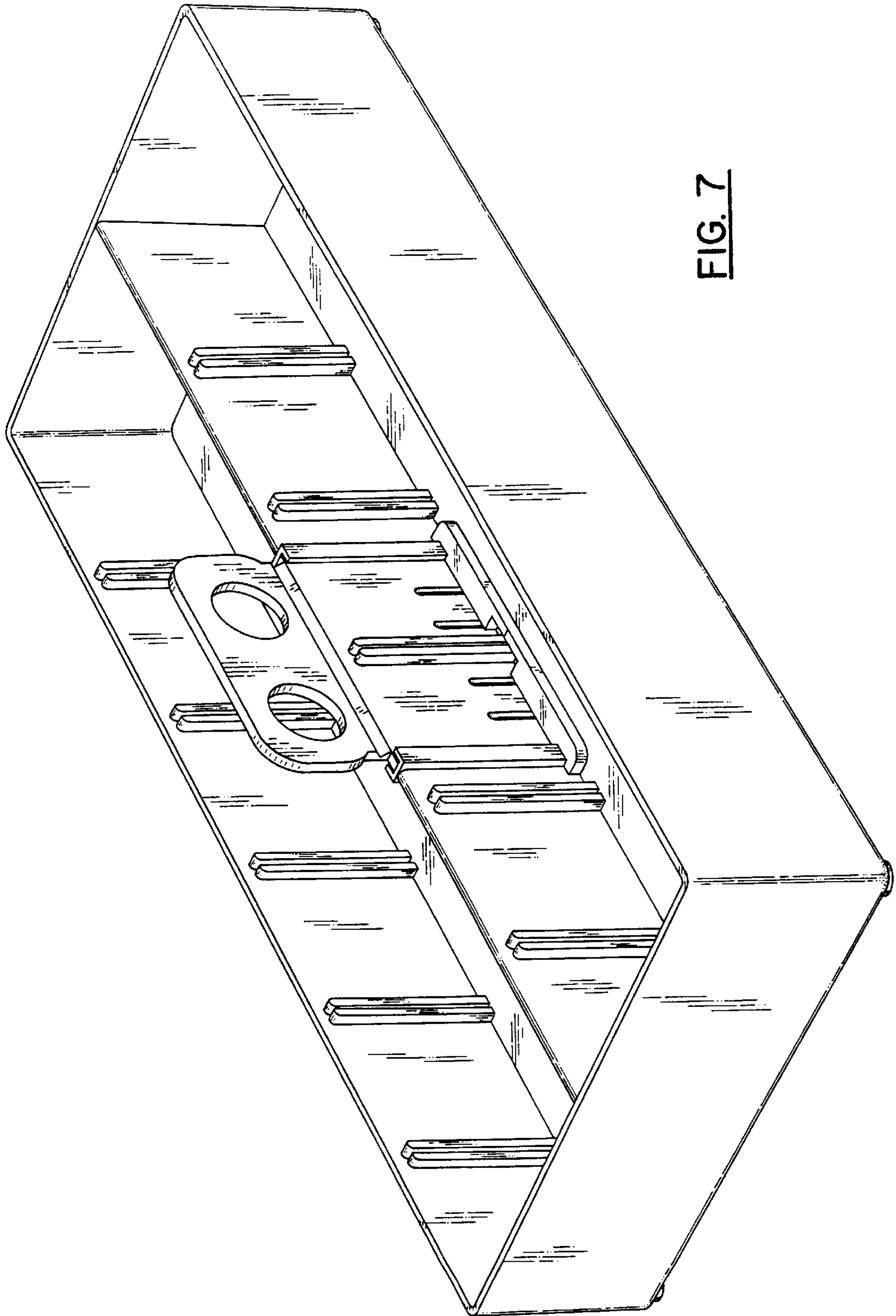

FIG. 7