



US00D422773S

United States Patent [19]
Klein

[11] **Patent Number: Des. 422,773**
[45] **Date of Patent: ** *Apr. 11, 2000**

[54] **MAILBOX**

[76] Inventor: **Theodore K. Klein**, 12310 Austin,
Palos Heights, Ill. 60463

[*] Notice: This patent is subject to a terminal disclaimer.

[**] Term: **14 Years**

[21] Appl. No.: **29/103,667**

[22] Filed: **Apr. 16, 1999**

[51] **LOC (6) Cl.** **99-00**

[52] **U.S. Cl.** **D99/30**

[58] **Field of Search** D99/29, 30; 232/17,
232/19, 20, 21, 22, 27; D25/233, 56; 52/518,
233; 446/106

[56] **References Cited**

U.S. PATENT DOCUMENTS

D. 158,292	4/1950	Keeler	D99/30
D. 166,749	5/1952	Heinz	D99/30
D. 256,287	8/1980	McConnell	D99/30
D. 291,937	9/1987	Fishor	D99/30
D. 296,602	7/1988	Klein	.	
D. 354,611	1/1995	Hazlett	D99/30
5,035,356	7/1991	Granger	232/17
5,143,284	9/1992	Socarras	232/21

OTHER PUBLICATIONS

- Smithsonian, Top Mailbox Shingle Roof p. 189, Nov. 1989.
- Home, Middle Right, Copper Top p. 22, Feb. 1996.
- Klein, Theodore K., AH 3 Plain Sides, Flat Roof, 1986, U.S.A.
- Klein, Theodore K., AH 5 Lattice Sides, Flat Roof, 1986, U.S.A.
- Klein, Theodore K., AH 12 Plain Sides, Shingled Roof, 1986, U.S.A.
- Klein, Theodore K., AH 14 Log Sides, Shingled Roof, 1986, U.S.A.
- Klein, Theodore K., AH 15 T111 Sides, Shingled Roof, 1986, U.S.A.
- Klein, Theodore K., AH 25 Shingled & Side Door For Paper, 1986, U.S.A.

- Klein, Theodore K., AH 12K Plain Sides, Kurfed Roof, 1986, U.S.A.
- Klein, Theodore K., AH 14K Log Sides, Kurfed Roof, 1986, U.S.A.
- Klein, Theodore K., AH 15K TK111 Sides, Kurfed Roof, 1986, U.S.A.
- Klein, Theodore K., CH 1 Plain Sides, Plain Roof, 1995, U.S.A.
- Klein, Theodore K., CH 2 Plain Sides, Plain Roof, 1995, U.S.A.
- Klein, Theodore K., CH 3 Grooved Sides, Shingled Roof, 1995, U.S.A.
- Klein, Theodore K., CH 4 Log Sides, Shingled Roof, 1995, U.S.A.
- Klein, Theodore K., CH 5 T111 Sides, Shingled Roof, 1995, U.S.A.
- Klein, Theodore K., CH 2K Plain Sides, Kurfed Roof, 1995, U.S.A.
- Klein, Theodore K., CH 3K Grooves Sides, Kurfed Roof, 1995, U.S.A.
- Klein, Theodore K., CH 4K Log Sides, Kurfed Roof, 1995, U.S.A.
- Klein, Theodore K., CH 5K T111 Sides, Kurfed Roof, 1995, U.S.A.

(List continued on next page.)

Primary Examiner—Paula A. Mortimer
Attorney, Agent, or Firm—Wildman, Harrold, Allen & Dixon; Thomas J. Ring

[57] **CLAIM**

The ornamental design for a mailbox, as shown and described.

DESCRIPTION

FIG. 1 is a perspective view of a mailbox;
FIG. 2 is a top plan view thereof;
FIG. 3 is a right side elevational view thereof;
FIG. 4 is a left side elevational view thereof;
FIG. 5 is a front elevational view thereof;
FIG. 6 is a rear elevational view thereof; and,
FIG. 7 is a bottom plan view thereof.

1 Claim, 2 Drawing Sheets

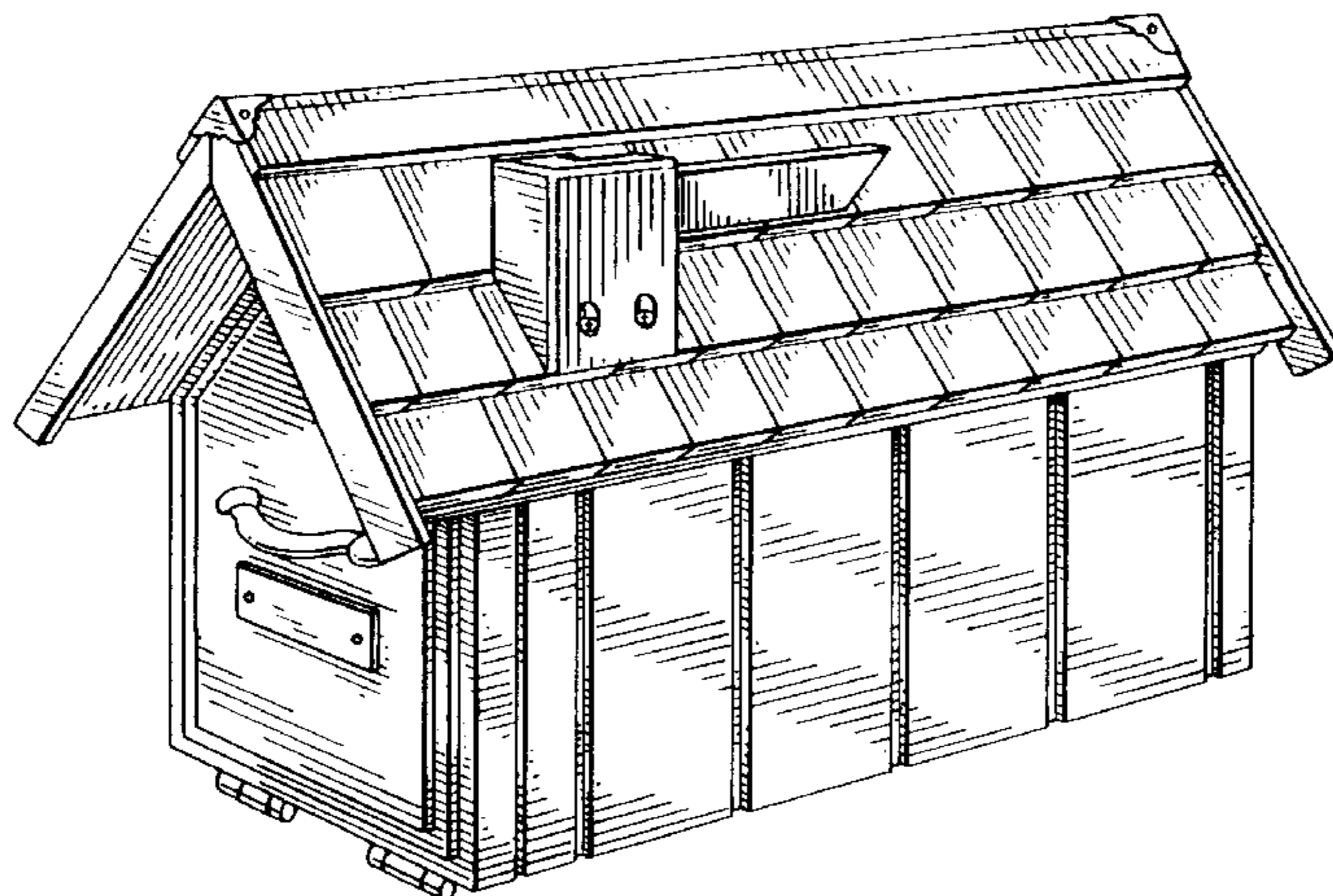

OTHER PUBLICATIONS

Klein, Theodore K., TK 101 Large Box, 4 Grooved Sides, 1984, U.S.A.

Klein, Theodore K., TK 102 Medium Box, 3 Grooved Sides, 1984, U.S.A.

Klein, Theodore K., TK 103 Small Box, 2 Grooved Sides, 19984, U.S.A.

Klein, Theodore K., CM 1 Plain Chimney, 1 Window, 1997, U.S.A.

Klein, Theodore K., CM 2 Plain Chimney, 2 Windows, 1997, U.S.A.

Klein, Theodore K., CM 3 Plain Chimney, 3 Windows, 1997, U.S.A.

Klein, Theodore K., CM 4 Stone Chimney, 4 Windows, 1997, U.S.A.

FIG. 1

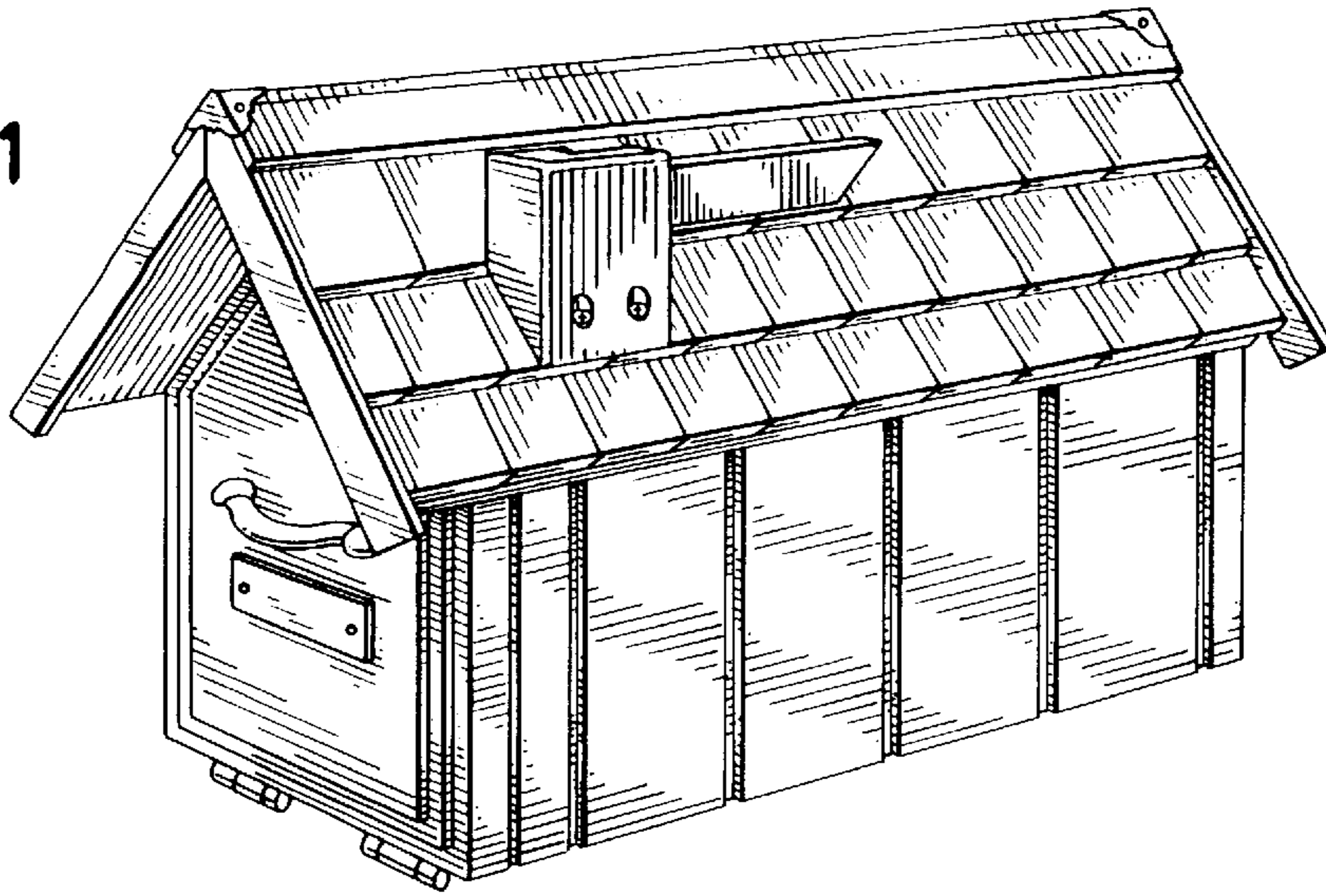

FIG. 2

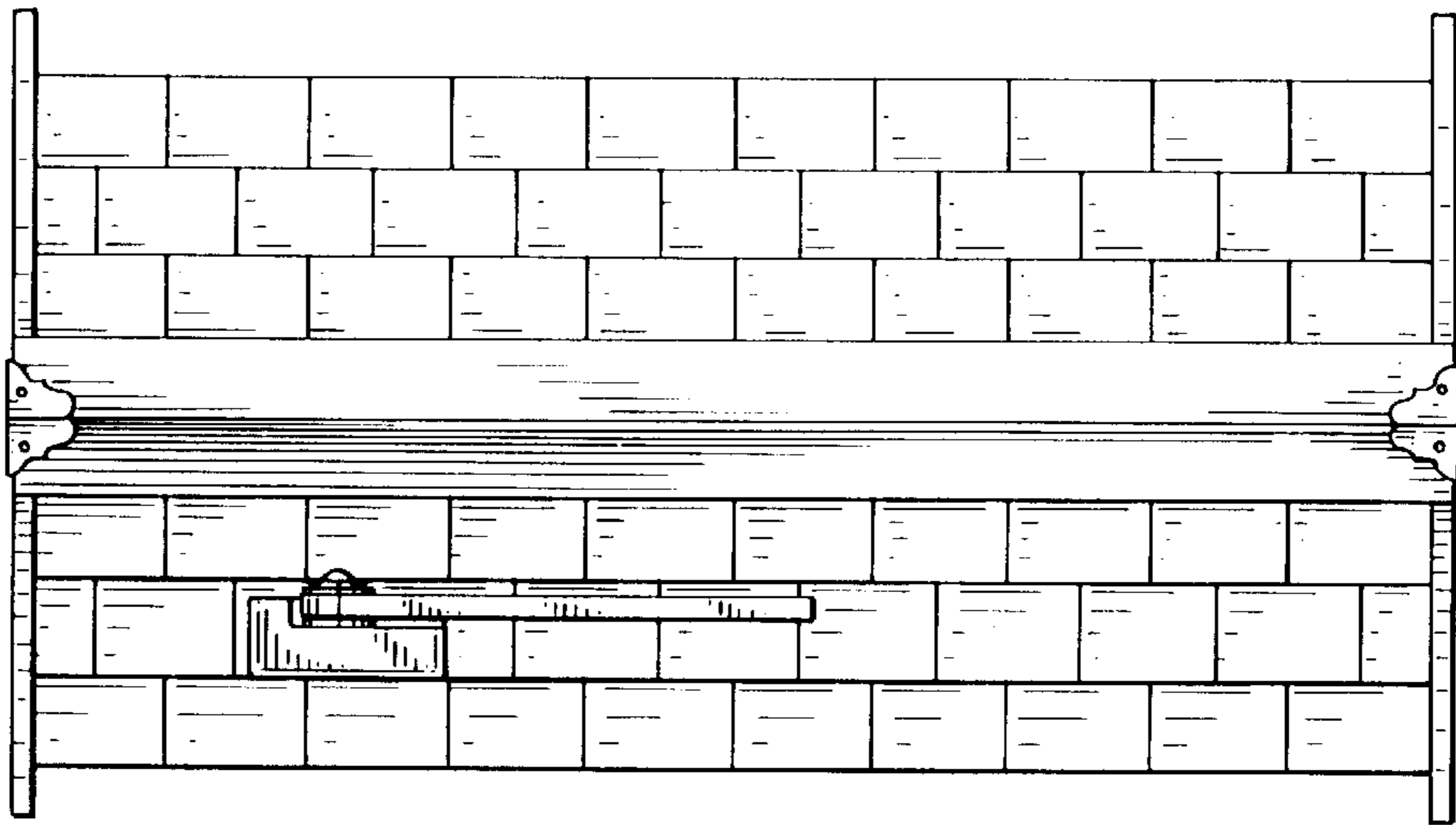

FIG. 3

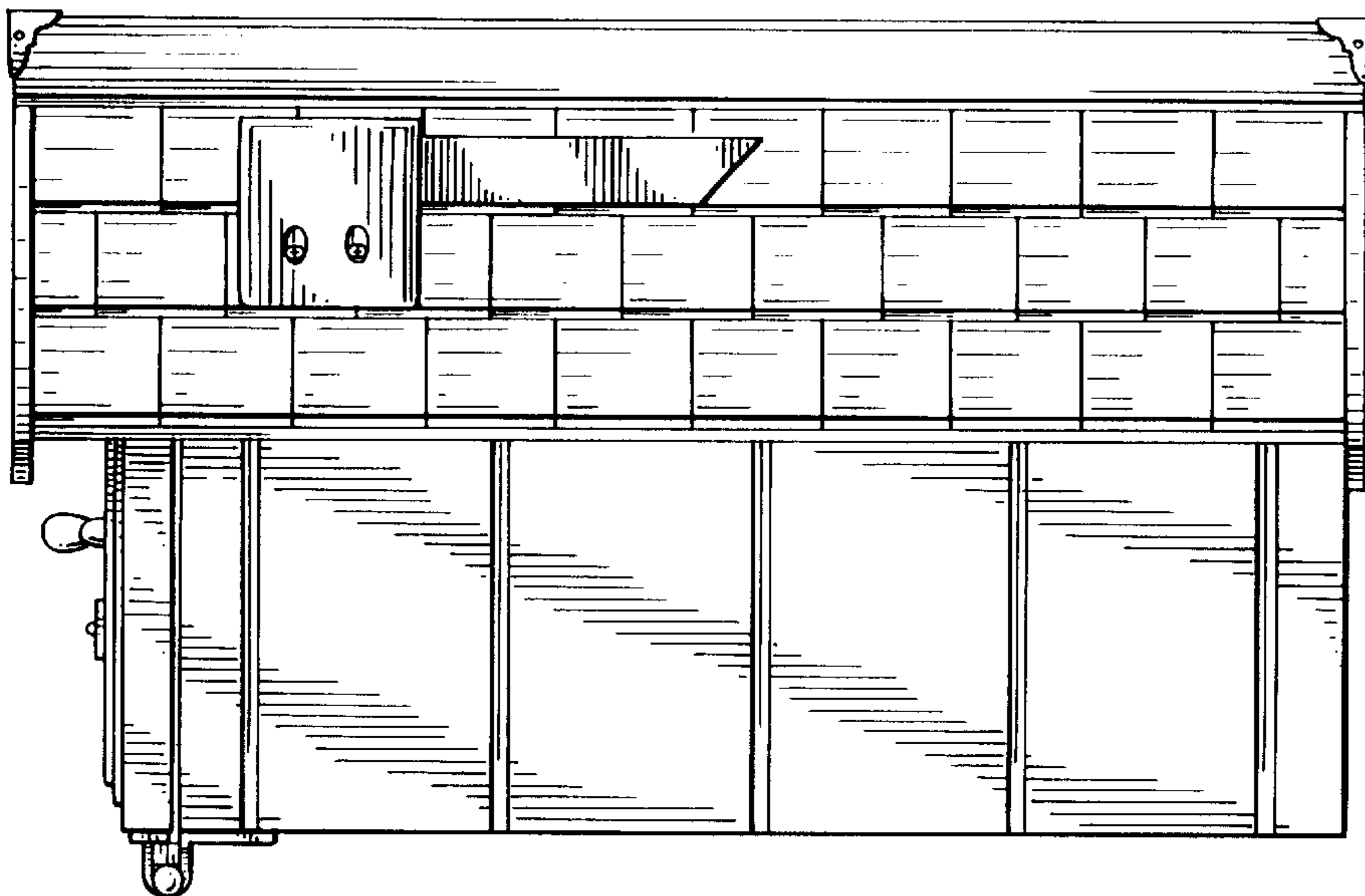

FIG. 4

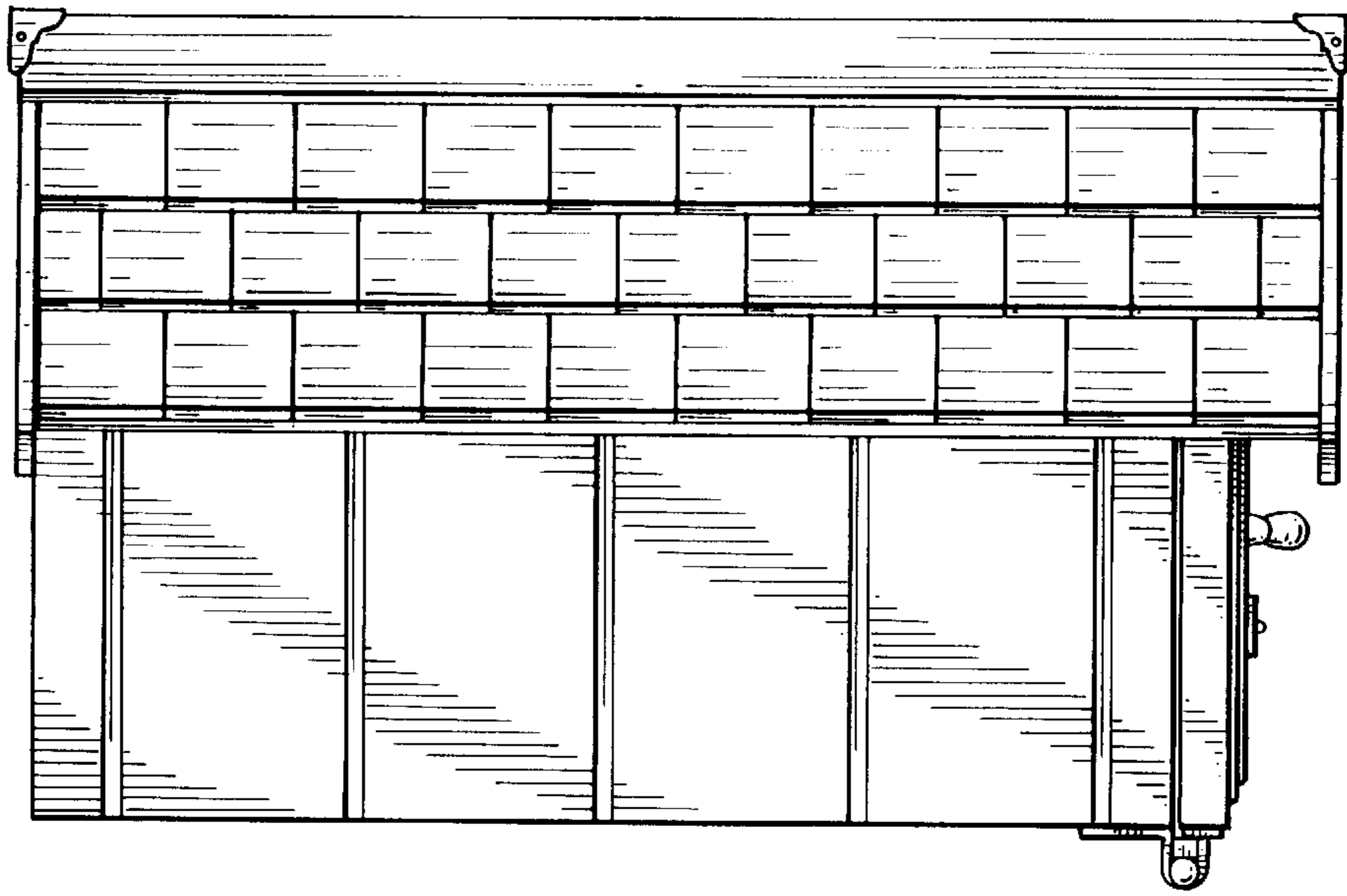

FIG. 5

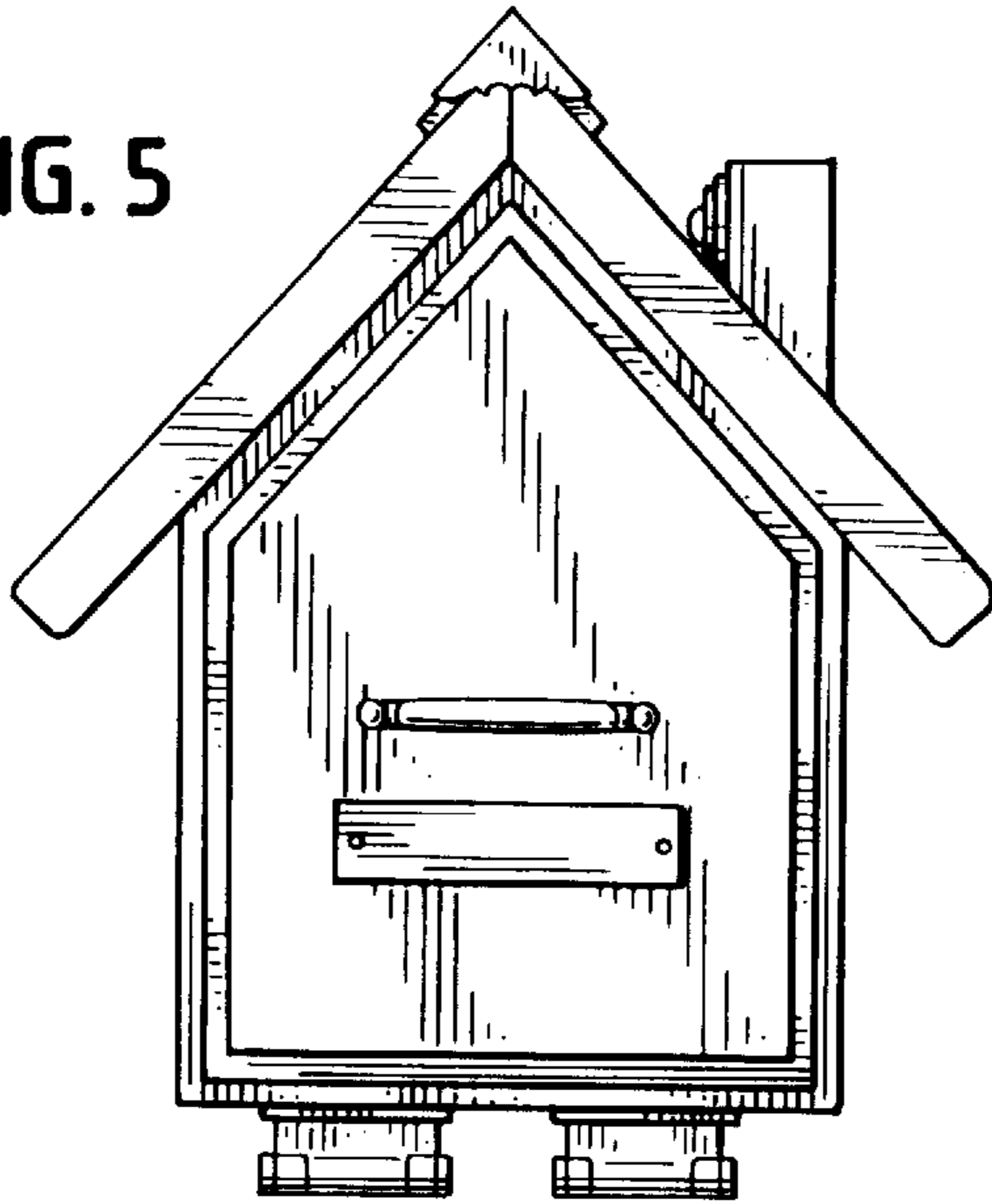

FIG. 6

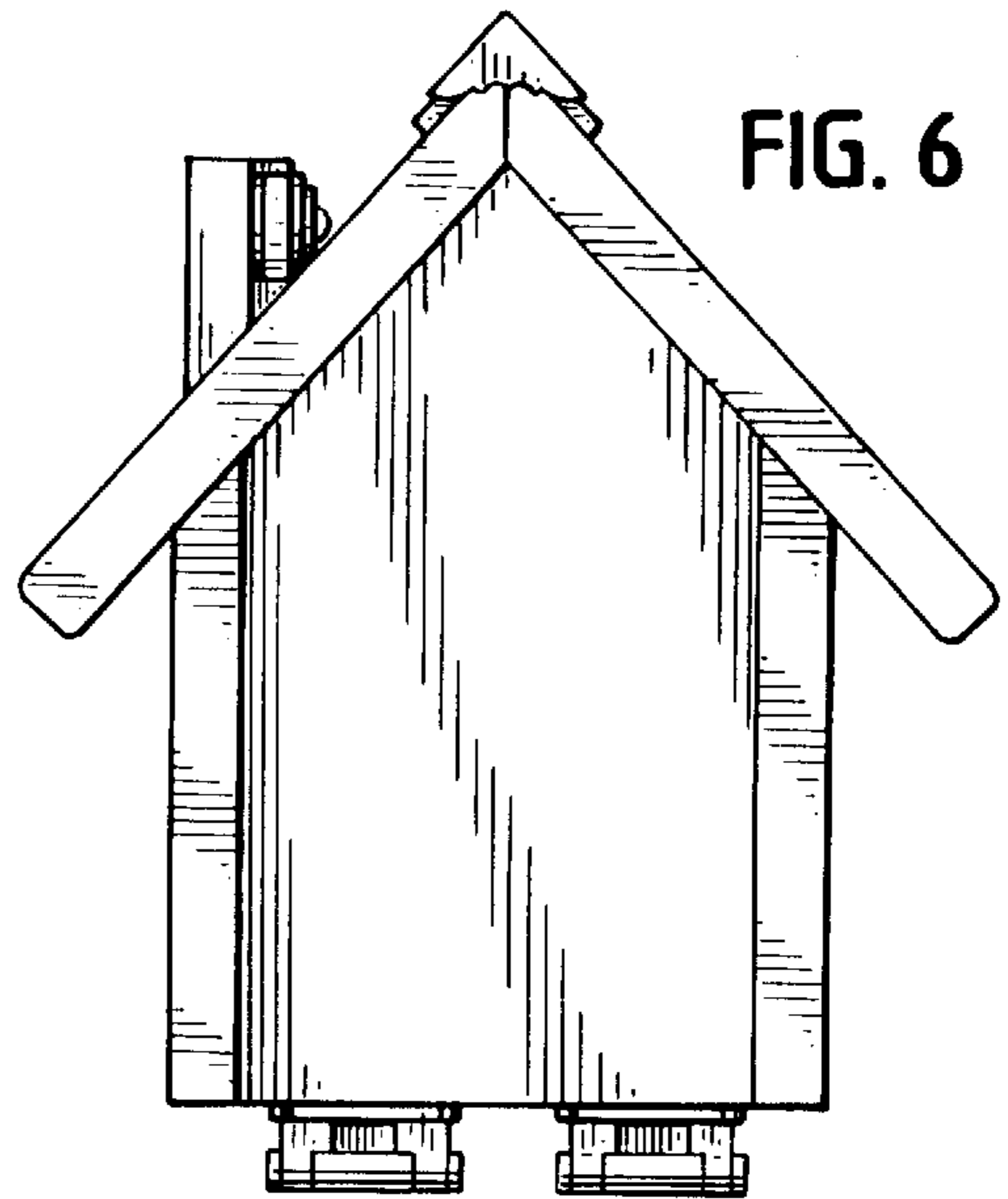

FIG. 7

