



US00D422637S

United States Patent [19]

[11] Patent Number: **Des. 422,637**

Harris et al.

[45] Date of Patent: **** Apr. 11, 2000**

[54] **VERTICAL CARD FILE**

Attorney, Agent, or Firm—Foley & Lardner

[75] Inventors: **David C. Harris**, Baraboo; **Mark S. Koehneke**, Milwaukee, both of Wis.; **John M. Fuller**, Vacaville, Calif.; **Jonathan P. Van Dore**, Minneapolis, Minn.; **Joshua Jung-hua Chang**, West Bloomfield, Mich.

[57] **CLAIM**

We claim the ornamental design for the vertical card file, as shown and described.

[73] Assignee: **Berol Corporation**, Freeport, Ill.

DESCRIPTION

[**] Term: **14 Years**

FIG. 1 is a perspective view of a vertical card file; FIG. 2 is a top plan view of the vertical card file shown in FIG. 1; FIG. 3 is a left side view of the vertical card file shown in FIG. 1; FIG. 4 is a right side view of the vertical card file shown in FIG. 1; FIG. 5 is a rear view of the vertical card file shown in FIG. 1; FIG. 6 is a bottom view of the vertical card file shown in FIG. 1; FIG. 7 is a front view of the vertical card file shown in FIG. 1; FIG. 8 is a perspective view of a second embodiment of a vertical card file; FIG. 9 is a top plan view of the vertical card file shown in FIG. 8; FIG. 10 is a left side view of the vertical card file shown in FIG. 8; FIG. 11 is a right side view of the vertical card file shown in FIG. 8; FIG. 12 is a bottom view of the vertical card file shown in FIG. 8; FIG. 13 is a top view of the vertical card file shown in FIG. 8; and, FIG. 14 is a front view of the vertical card file shown in FIG. 8.

[21] Appl. No.: **29/096,563**

[22] Filed: **Nov. 13, 1998**

[51] **LOC (6) Cl.** **19-02**

[52] **U.S. Cl.** **D19/75; D19/76; D19/90; D6/634**

[58] **Field of Search** **D19/65, 75, 76, D19/86, 78, 90, 91, 95, 99, 100; D6/632, 634; D34/7; 211/10, 11, 50, 55; 206/425, 449, 307, 308.1**

The broken lines showing portions of the vertical card file are for illustrative purposes only and form no part of the claimed invention.

[56] **References Cited**

U.S. PATENT DOCUMENTS

D. 203,630	2/1966	Wright	D34/7
D. 270,549	9/1983	Burton et al.	.	
D. 280,423	9/1985	Burton et al.	.	
D. 283,902	5/1986	Goertz	.	
D. 285,215	8/1986	Roskvisf	D19/76
D. 304,345	10/1989	Foran	D19/75
D. 318,758	8/1991	Mervar et al.	D19/75 X
D. 323,675	2/1992	Klodt	D19/75
4,035,938	7/1977	Neilsen	.	
4,165,575	8/1979	Neilsen	.	
4,231,624	11/1980	Neilsen	.	
4,848,574	7/1989	Murphy et al.	211/50 X
4,906,057	3/1990	Davi et al.	.	
5,205,625	4/1993	Koch	312/9.54

Primary Examiner—Martie K. Holtje

1 Claim, 4 Drawing Sheets

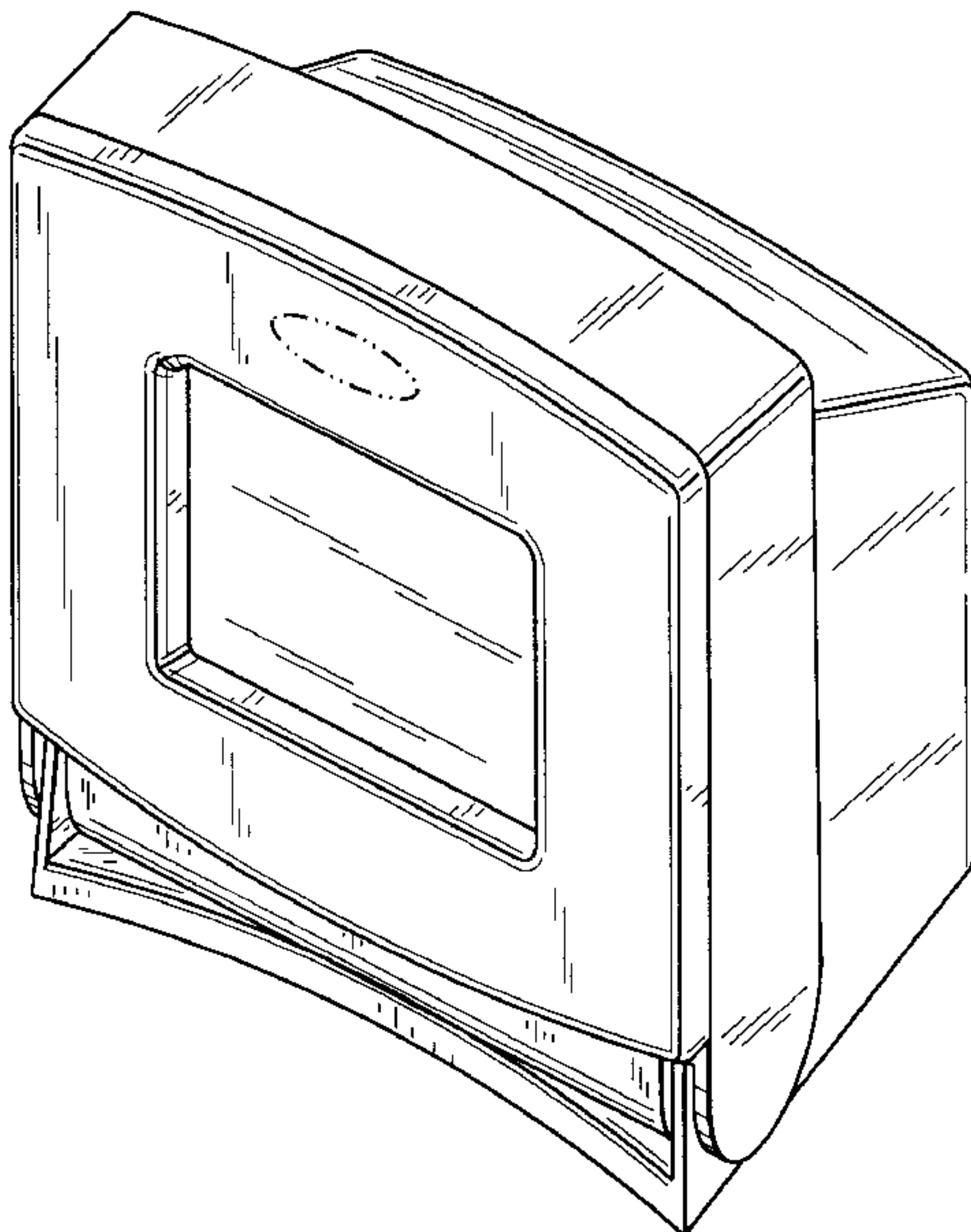

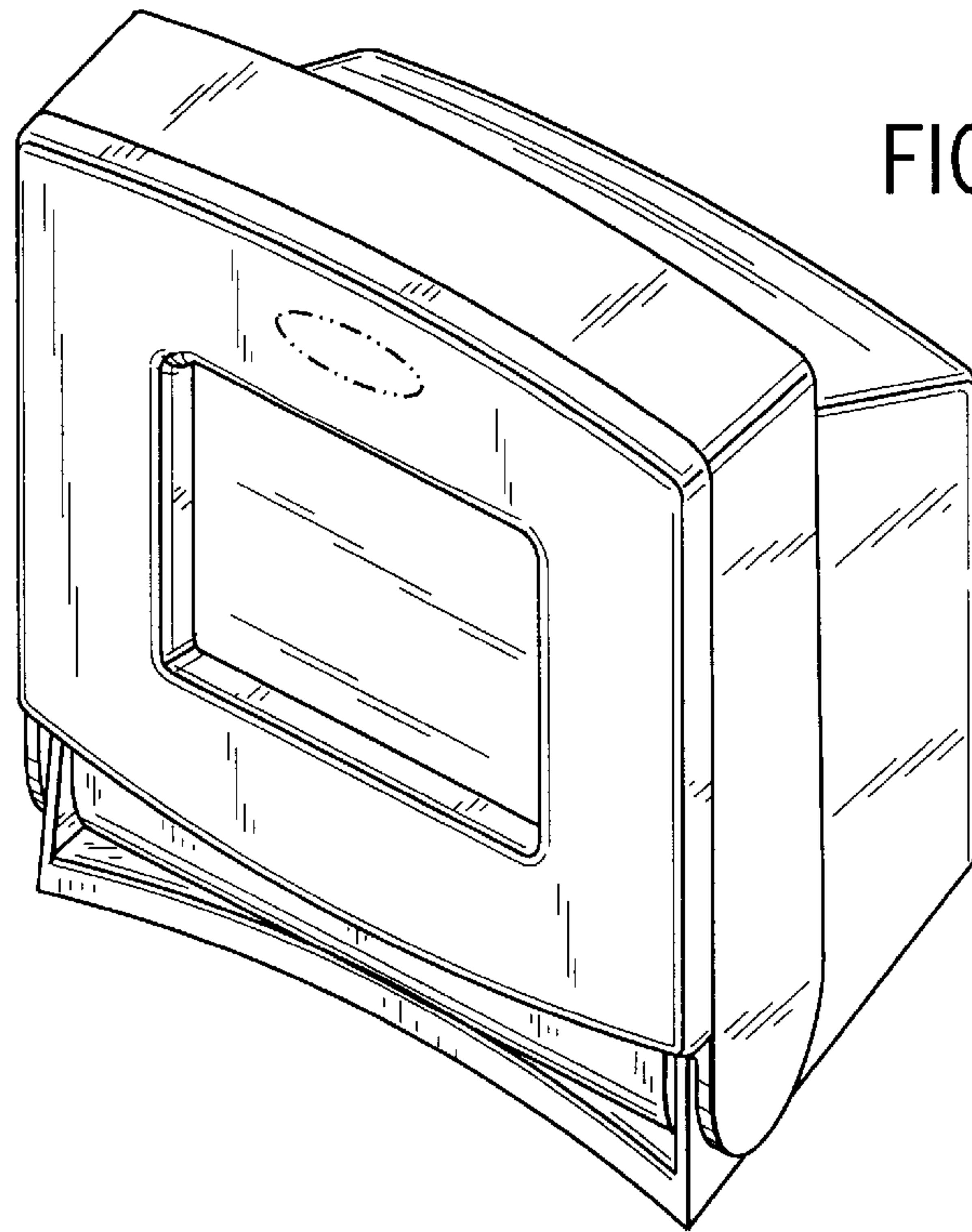

FIG. 1

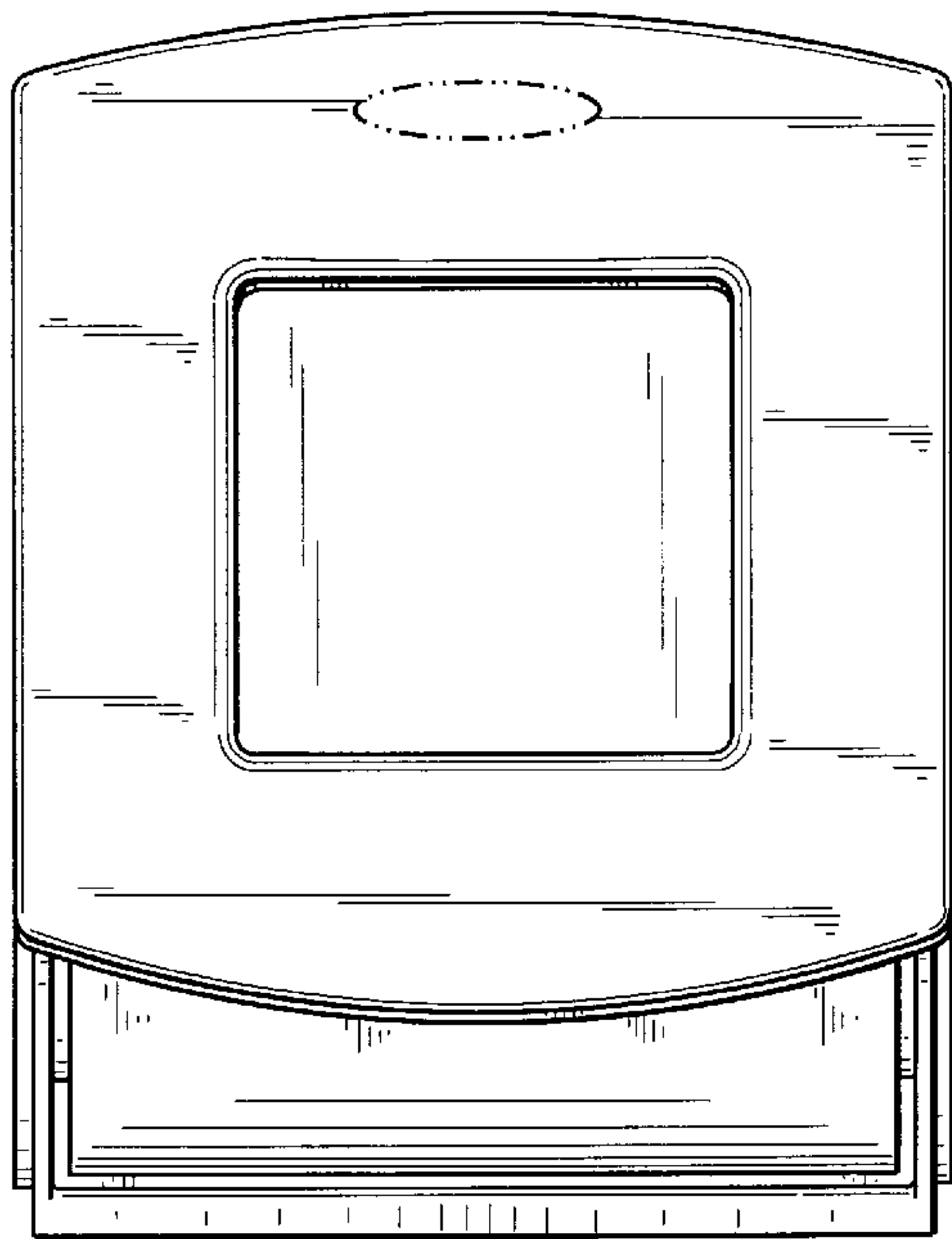

FIG. 2

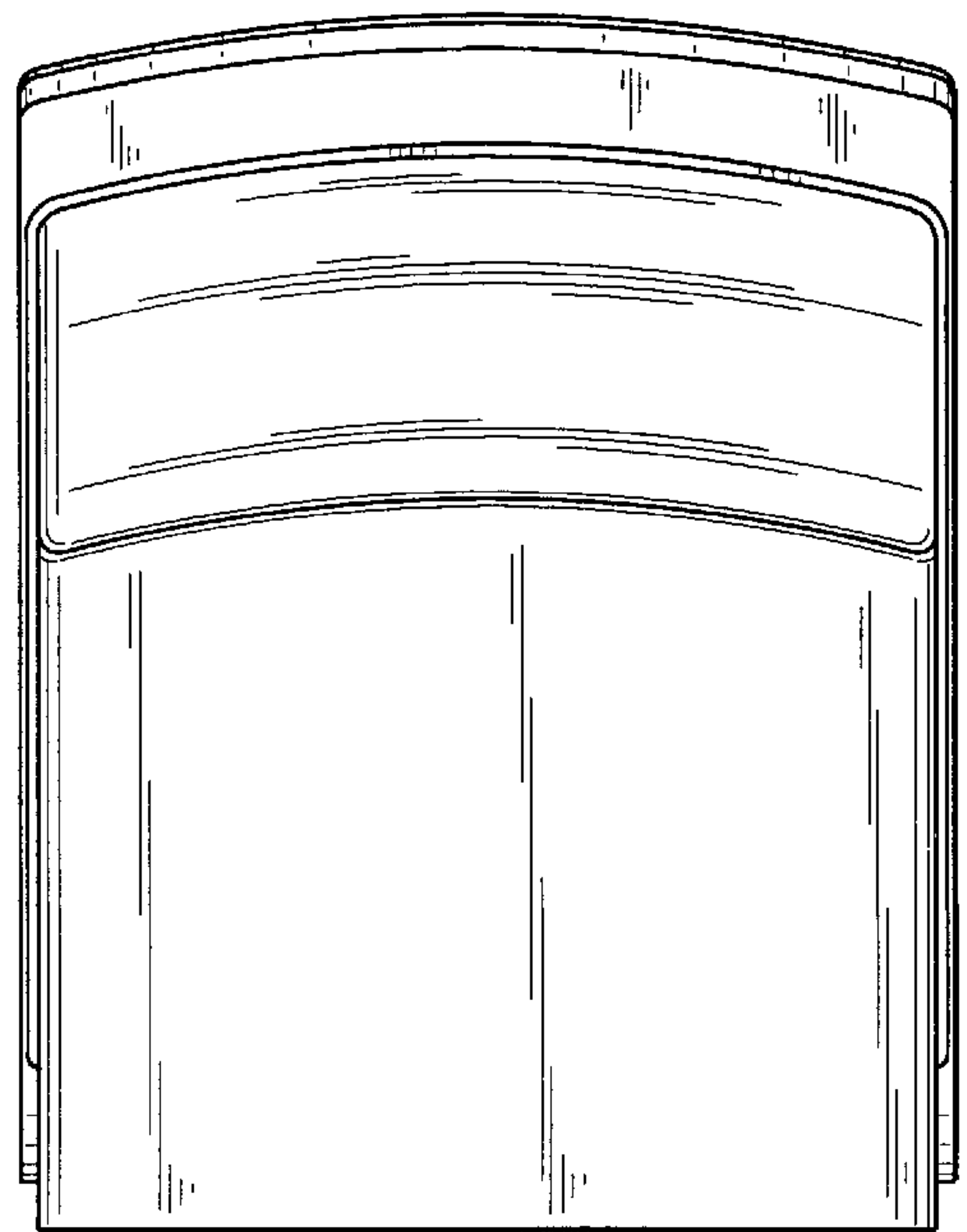

FIG. 5

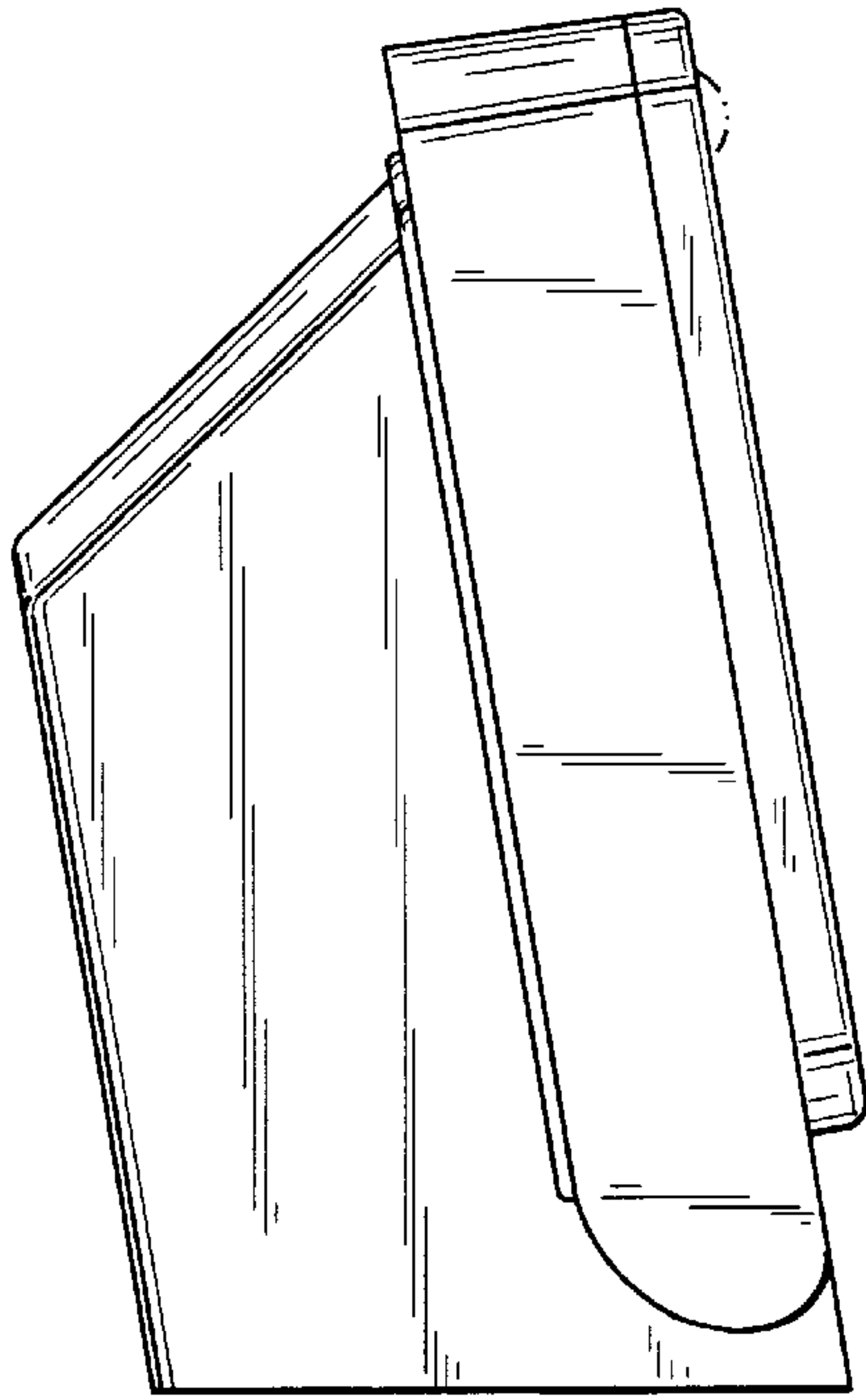

FIG. 3

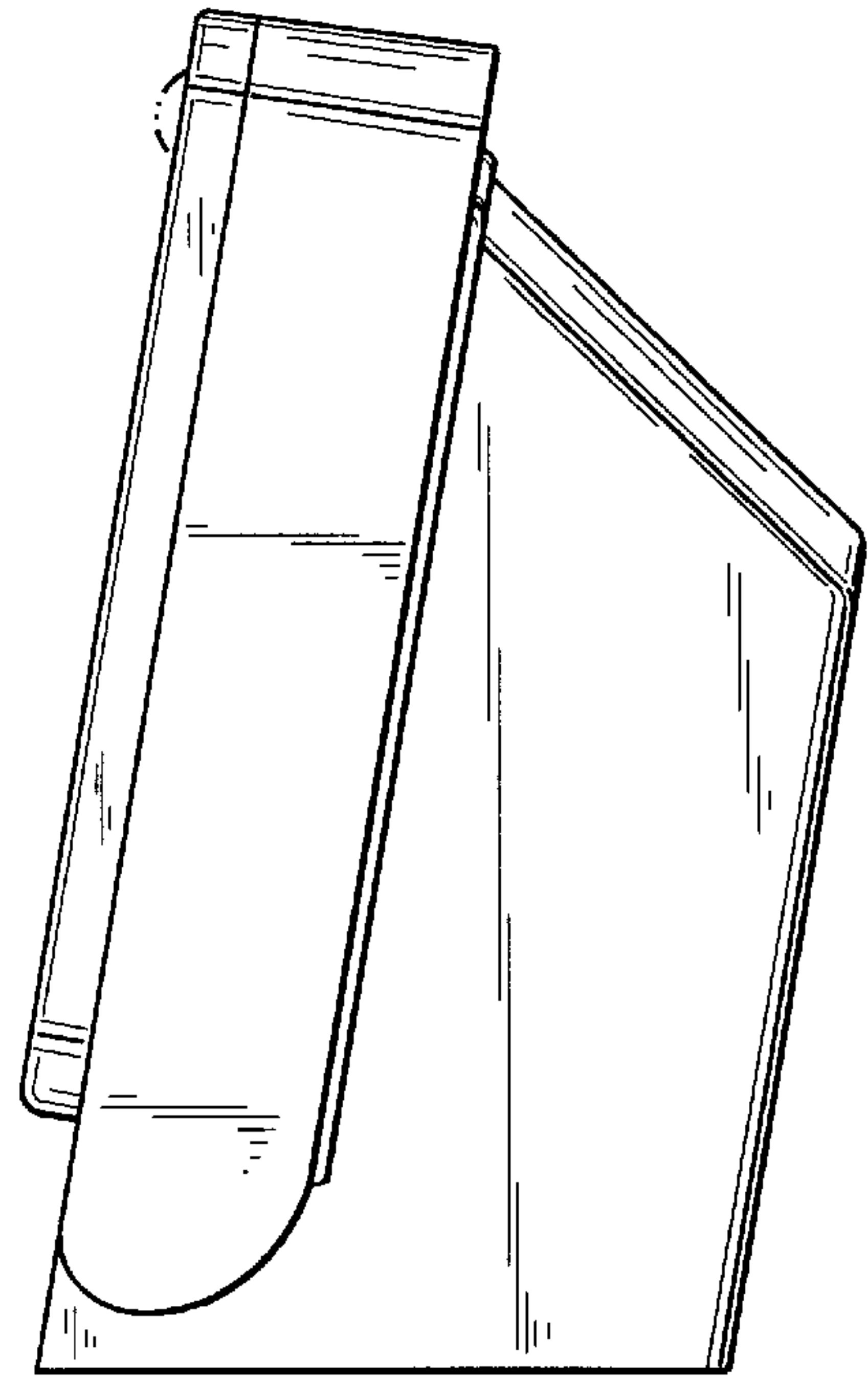

FIG. 4

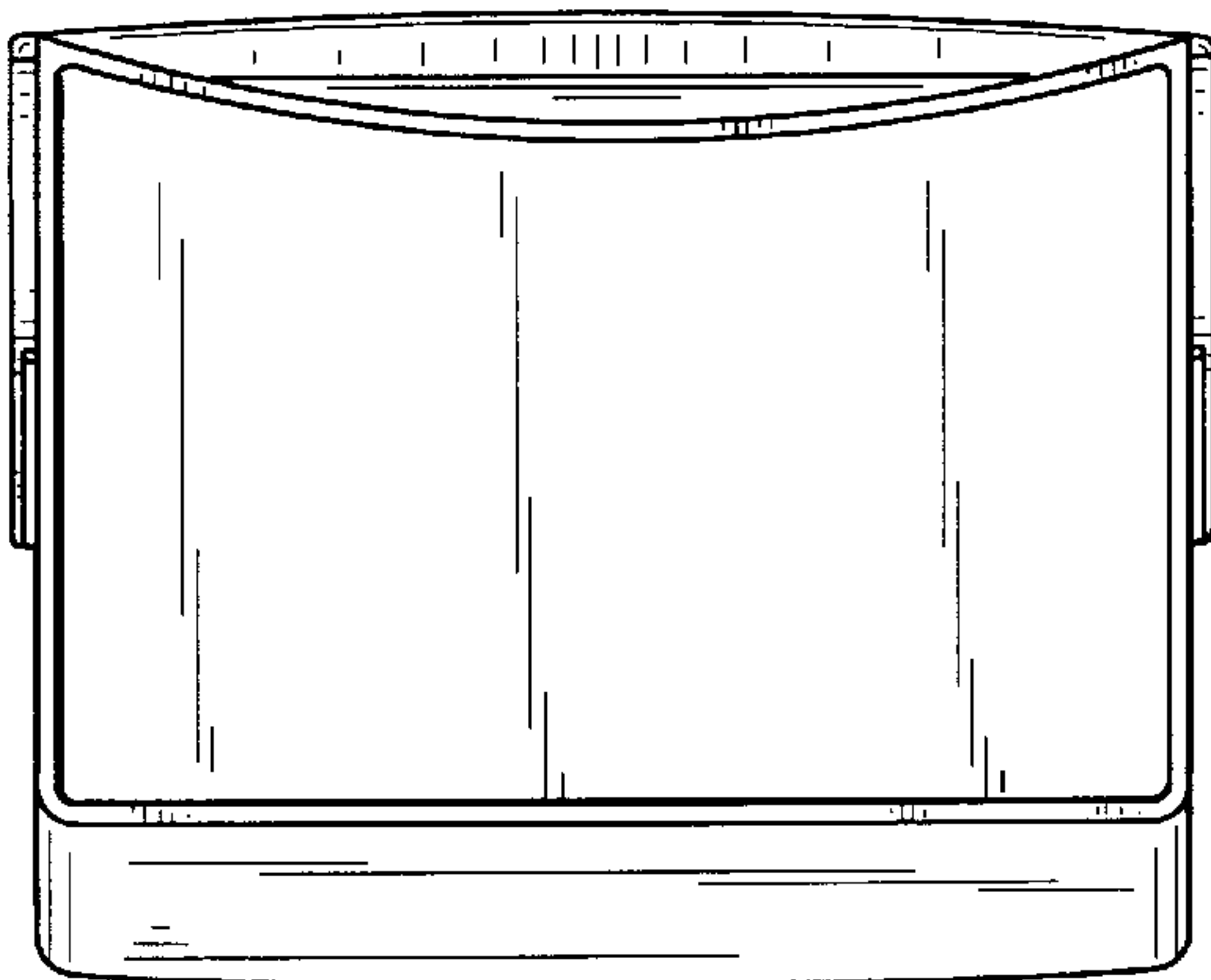

FIG. 6

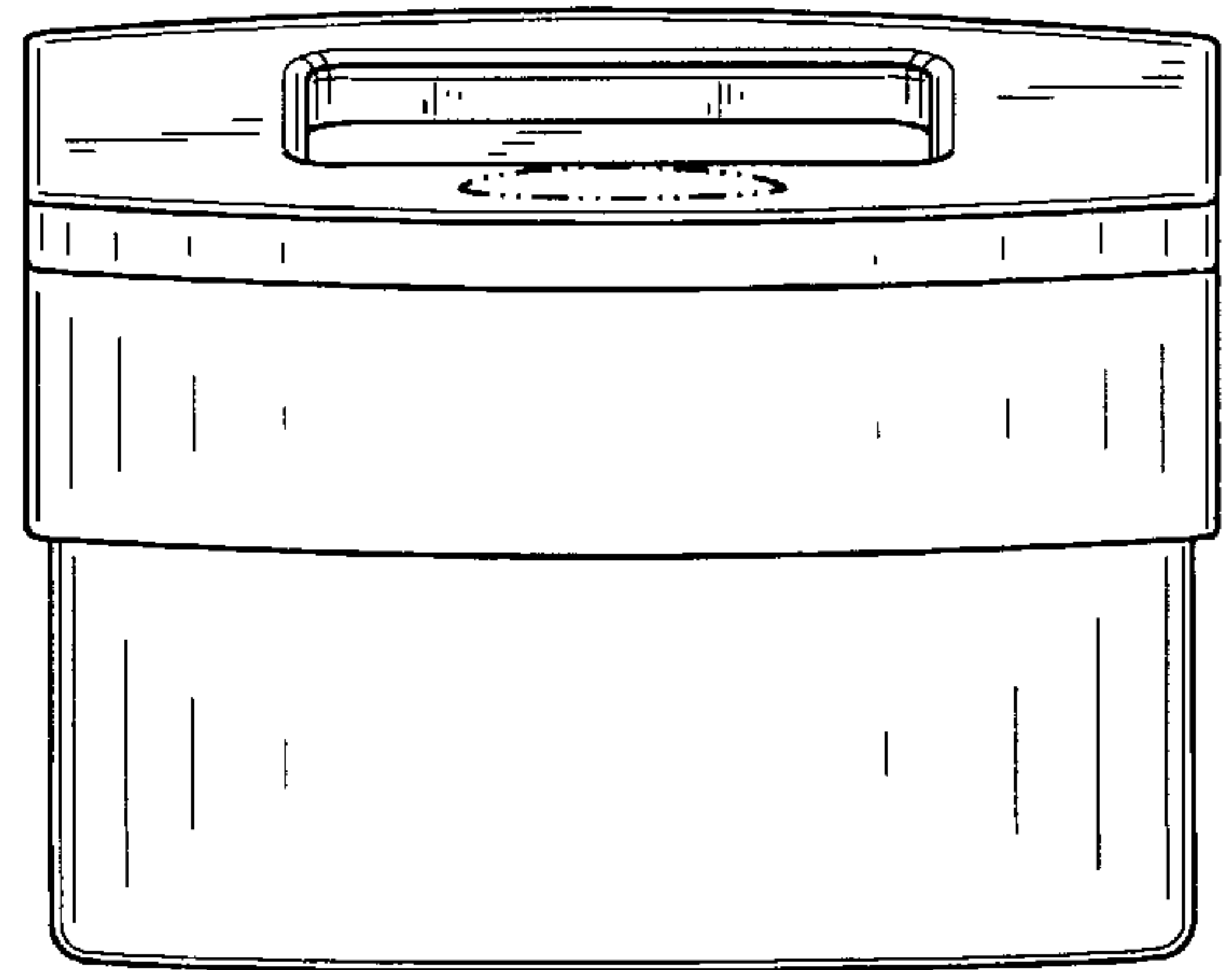

FIG. 7

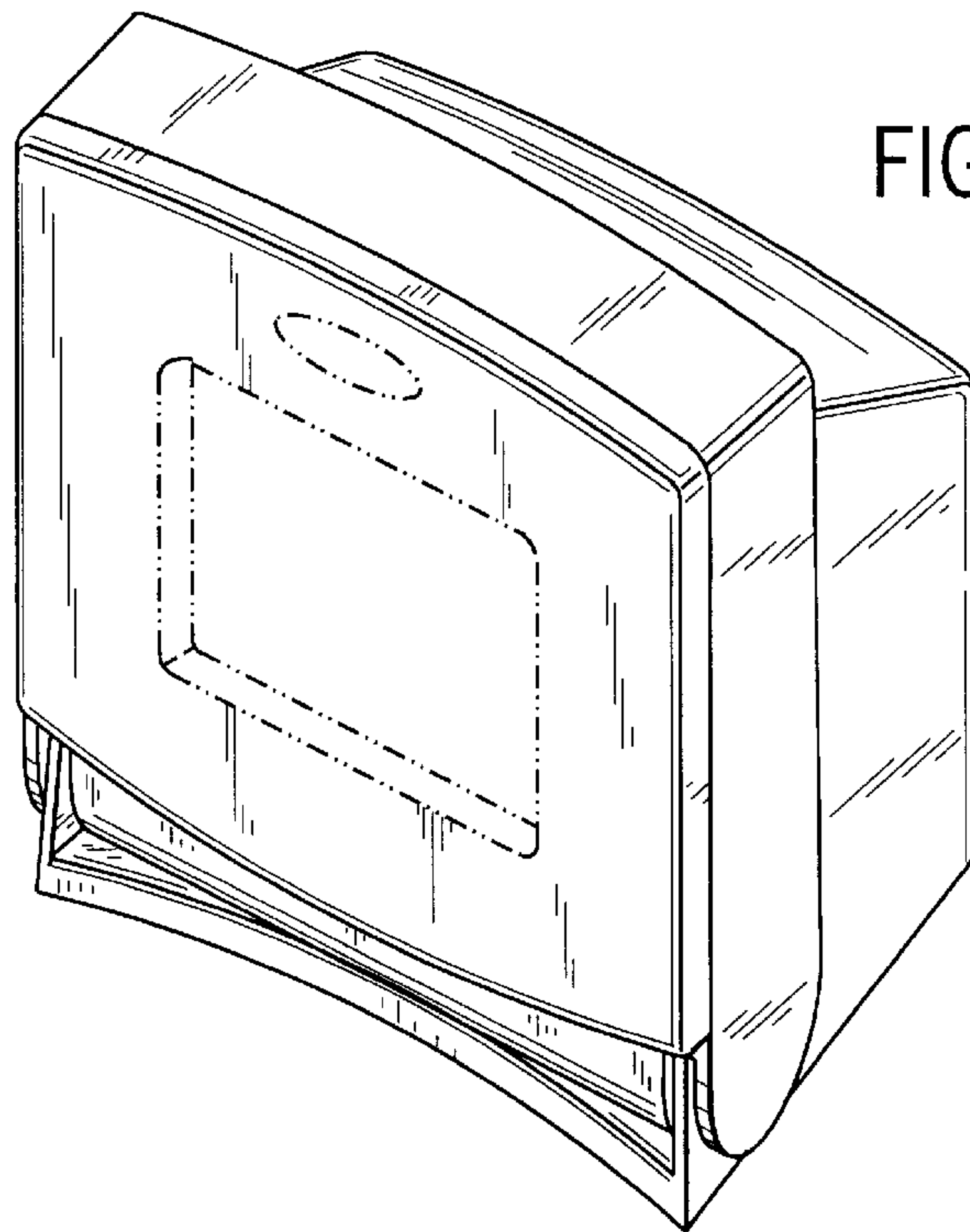

FIG. 8

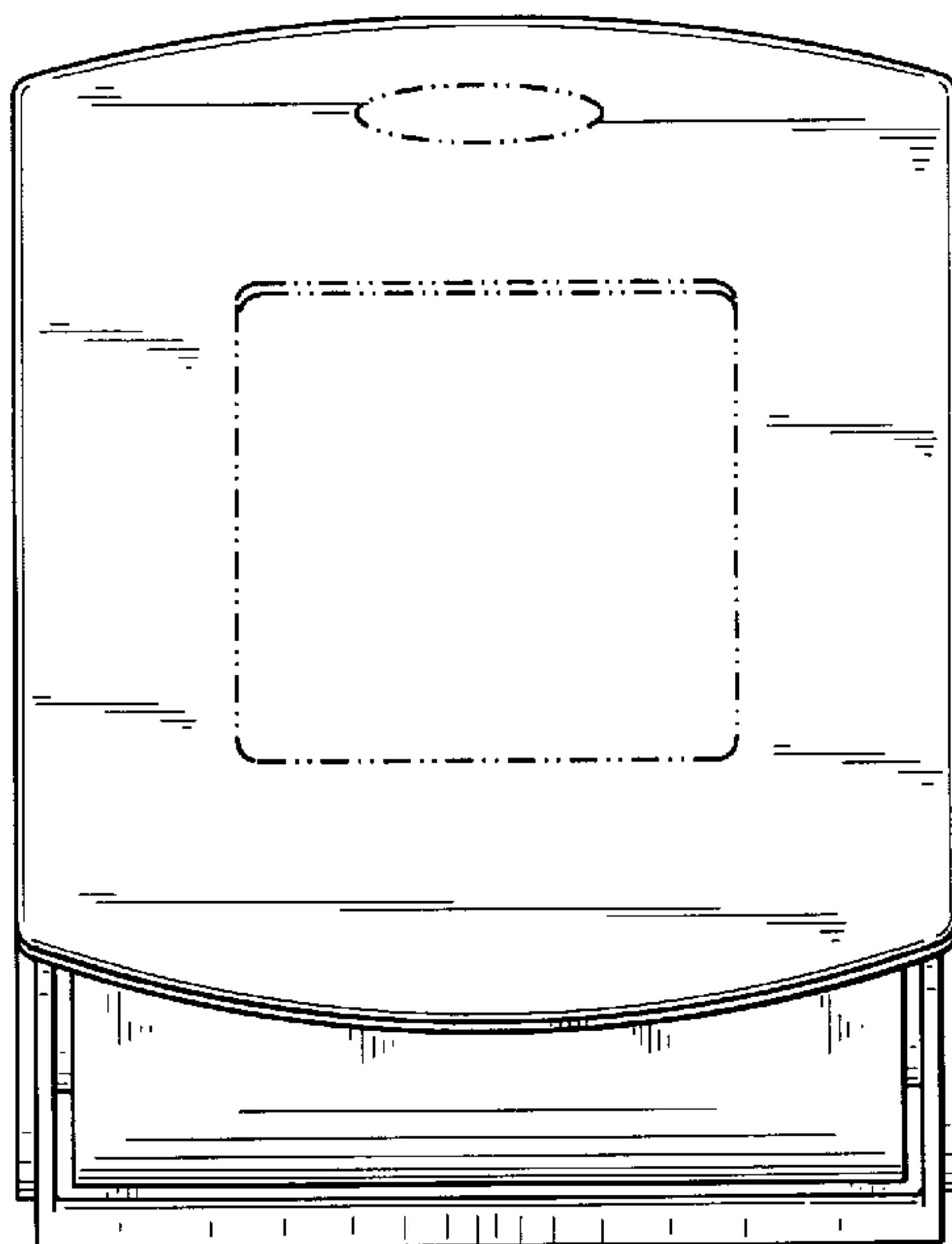

FIG. 9

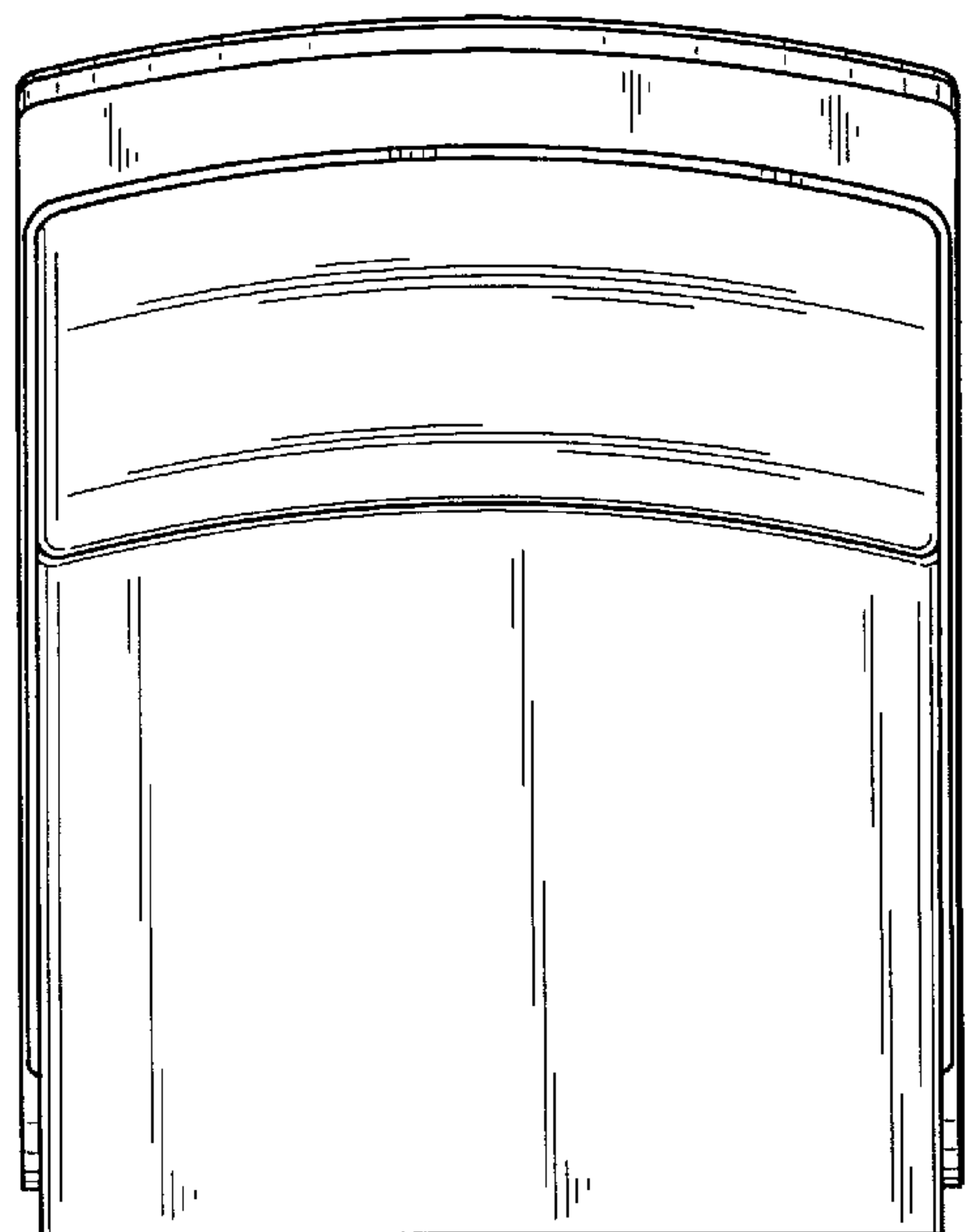

FIG. 12

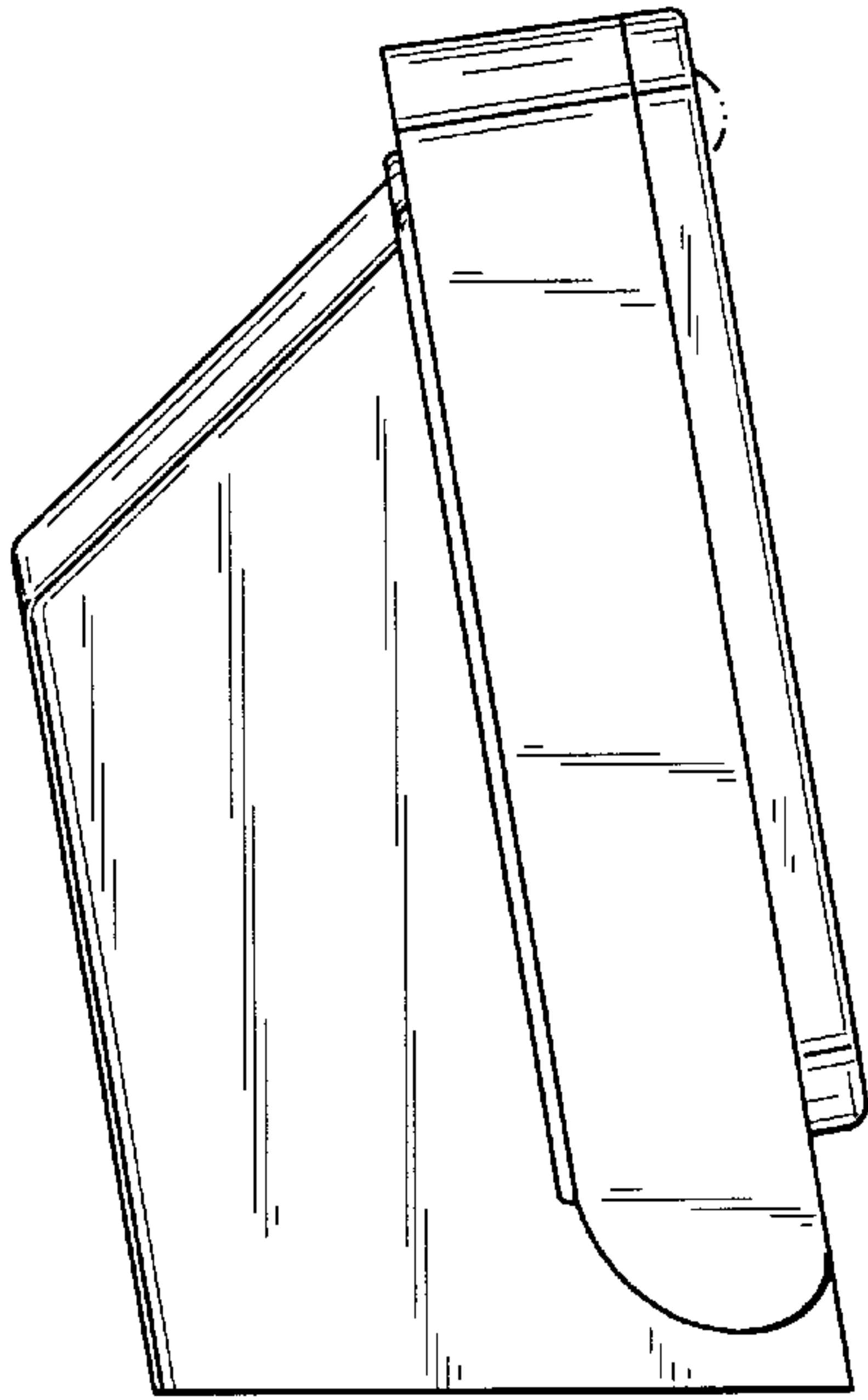

FIG. 10

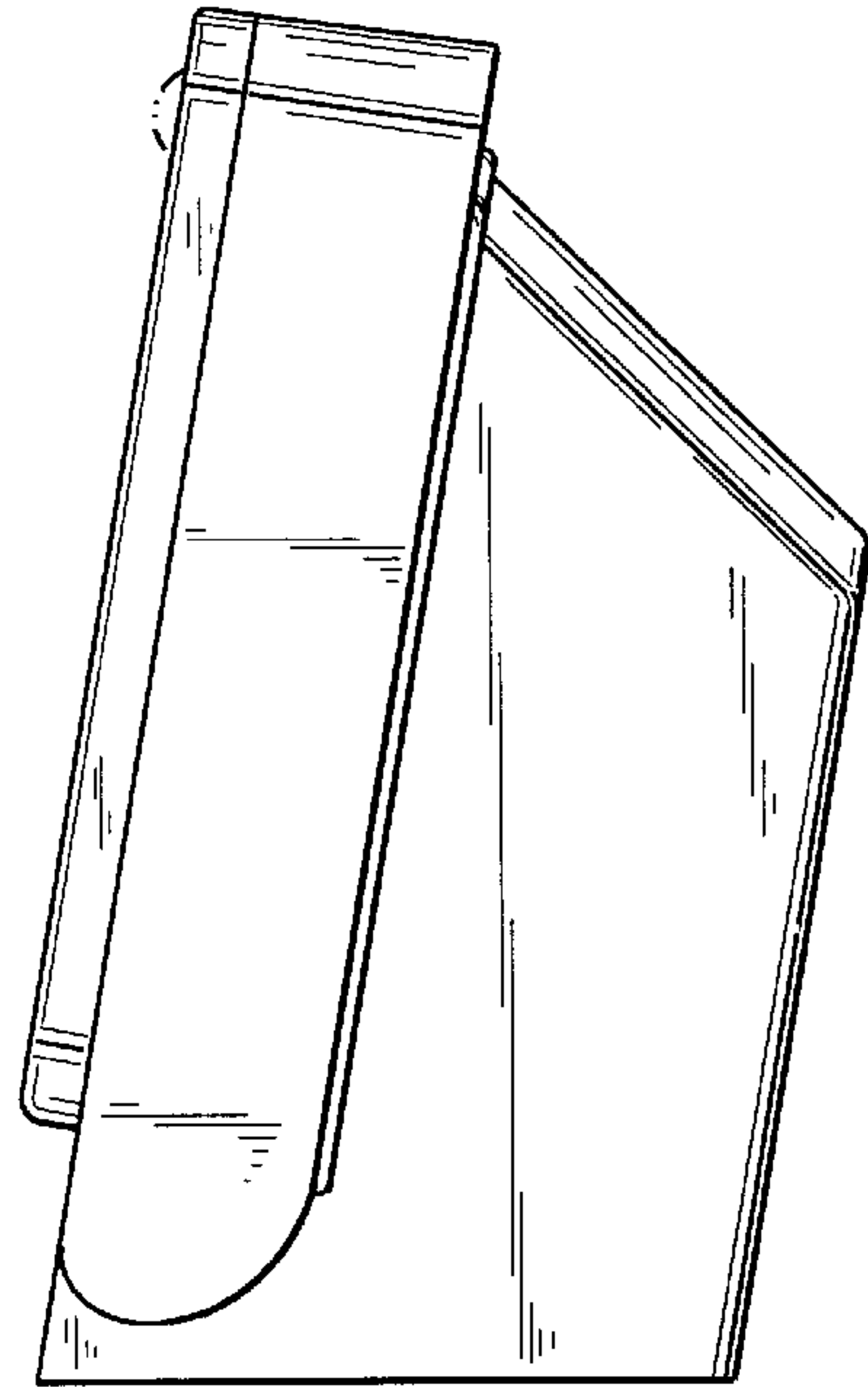

FIG. 11

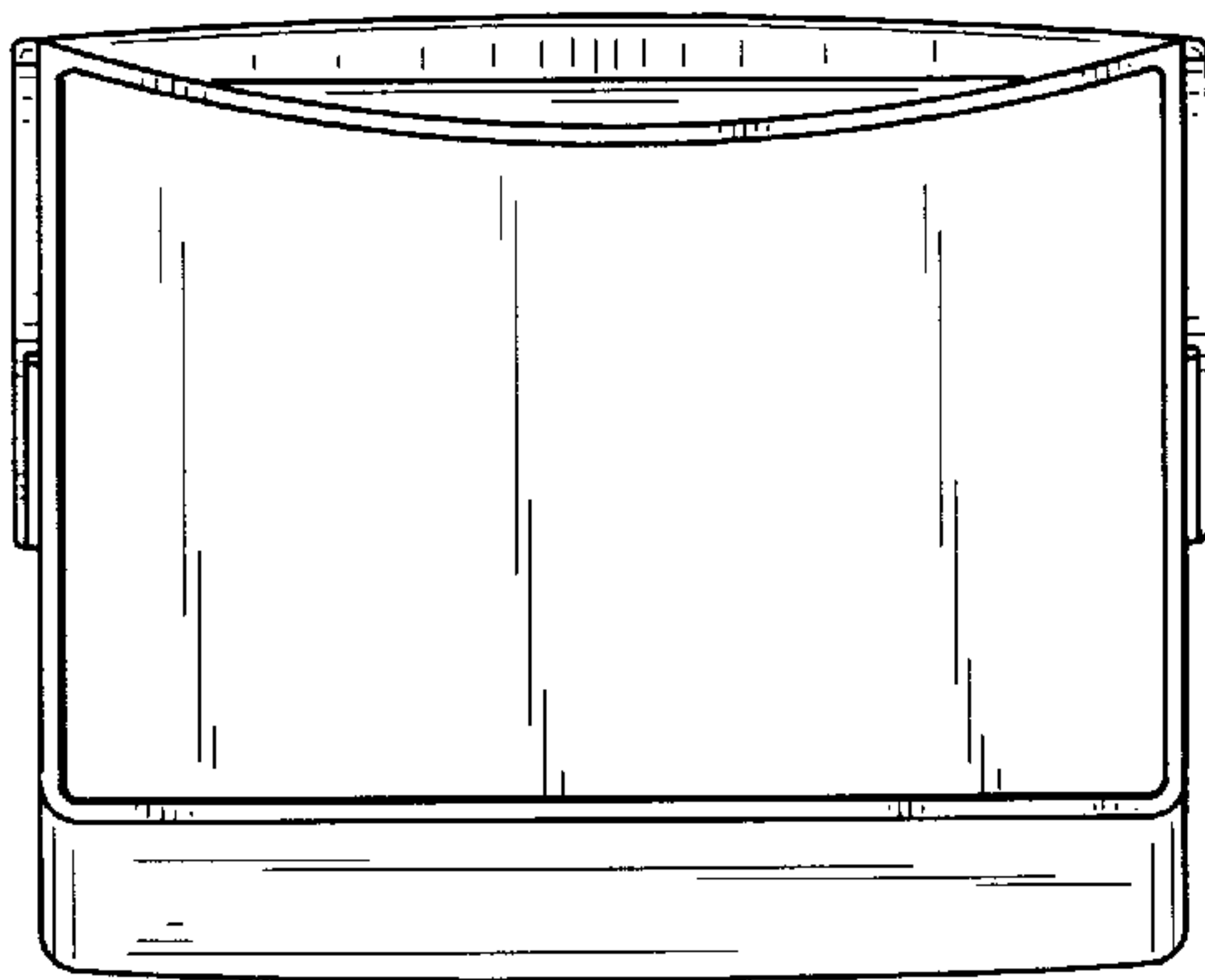

FIG. 13

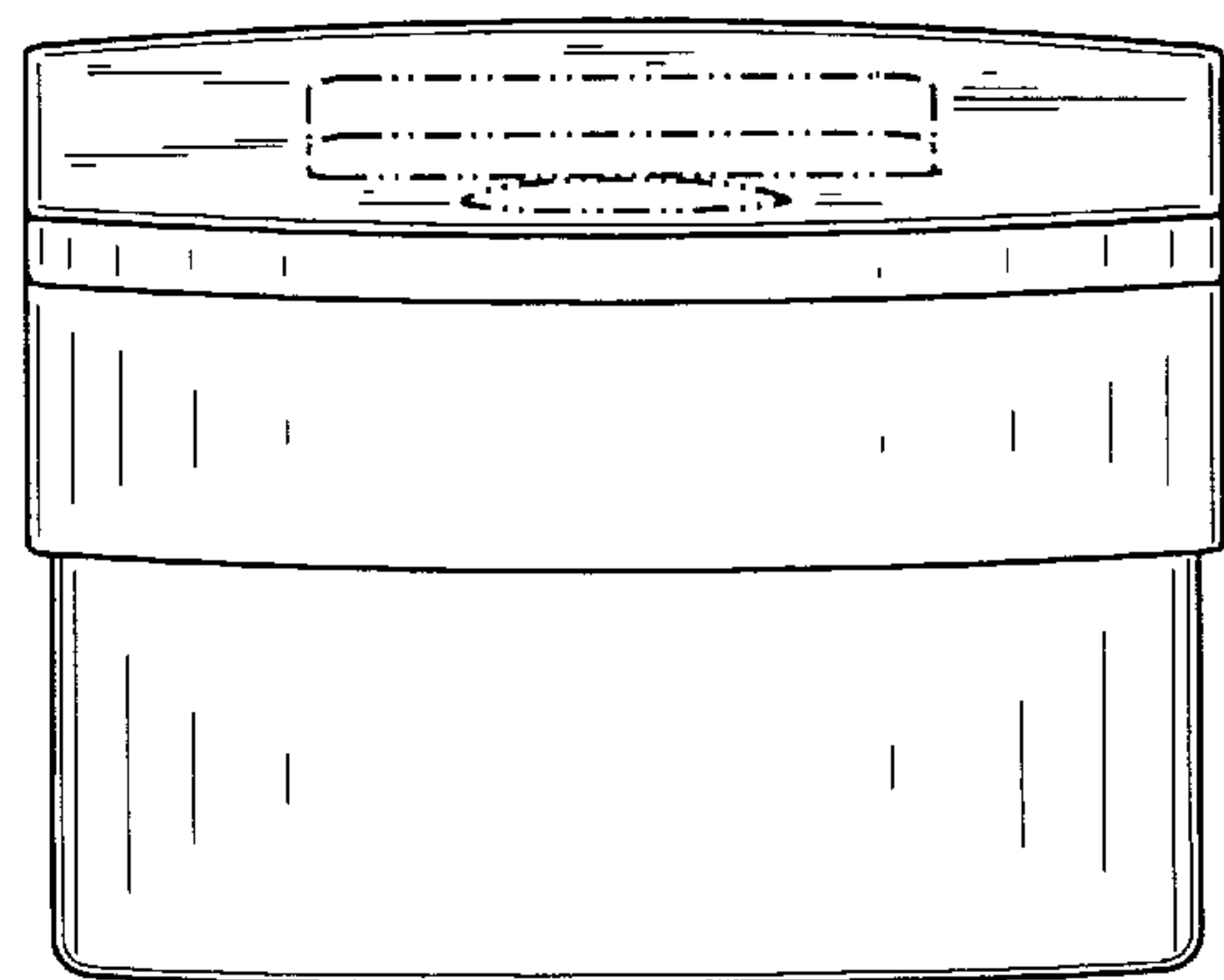

FIG. 14