



US00D422592S

United States Patent [19] Deguchi

[11] Patent Number: **Des. 422,592**

[45] Date of Patent: **** Apr. 11, 2000**

[54] **HEADPHONE**

[75] Inventor: **Michio Deguchi**, Tokyo, Japan

[73] Assignee: **Sony Corporation**, Tokyo, Japan

[**] Term: **14 Years**

[21] Appl. No.: **29/098,525**

[22] Filed: **Dec. 30, 1998**

[51] **LOC (6) Cl.** **14-01**

[52] **U.S. Cl.** **D14/205**

[58] **Field of Search** D14/192, 205,
D14/206, 223; 181/129, 130; 379/430,
431; 381/309, 370

[56] **References Cited**

U.S. PATENT DOCUMENTS

D. 254,183	2/1980	Doodson	D14/205
D. 353,818	12/1994	Makamura	D14/205
D. 358,390	5/1995	Hayashi	D14/205
D. 358,391	5/1995	Isono	D14/205

OTHER PUBLICATIONS

Catalog, "89", pp. 235, 236, 244 & 245, Sony, (Jul. 1998).
Catalog, "Sony inside No. 8 Spring/Summer 98", p. 61,
Sony, (Spring/Summer 1998).

Primary Examiner—Nanda Bondade
Attorney, Agent, or Firm—Foley & Lardner

[57] **CLAIM**

The ornamental design for a headphone, as shown and described.

DESCRIPTION

FIG. 1 is a perspective view of a headphone showing my new design;
FIG. 2 is a top plan view thereof;
FIG. 3 is a front elevational view thereof;
FIG. 4 is a left side elevational view thereof;
FIG. 5 is a right side elevational view thereof;
FIG. 6 is a bottom plan view thereof; and,
FIG. 7 is a rear elevational view thereof.

1 Claim, 4 Drawing Sheets

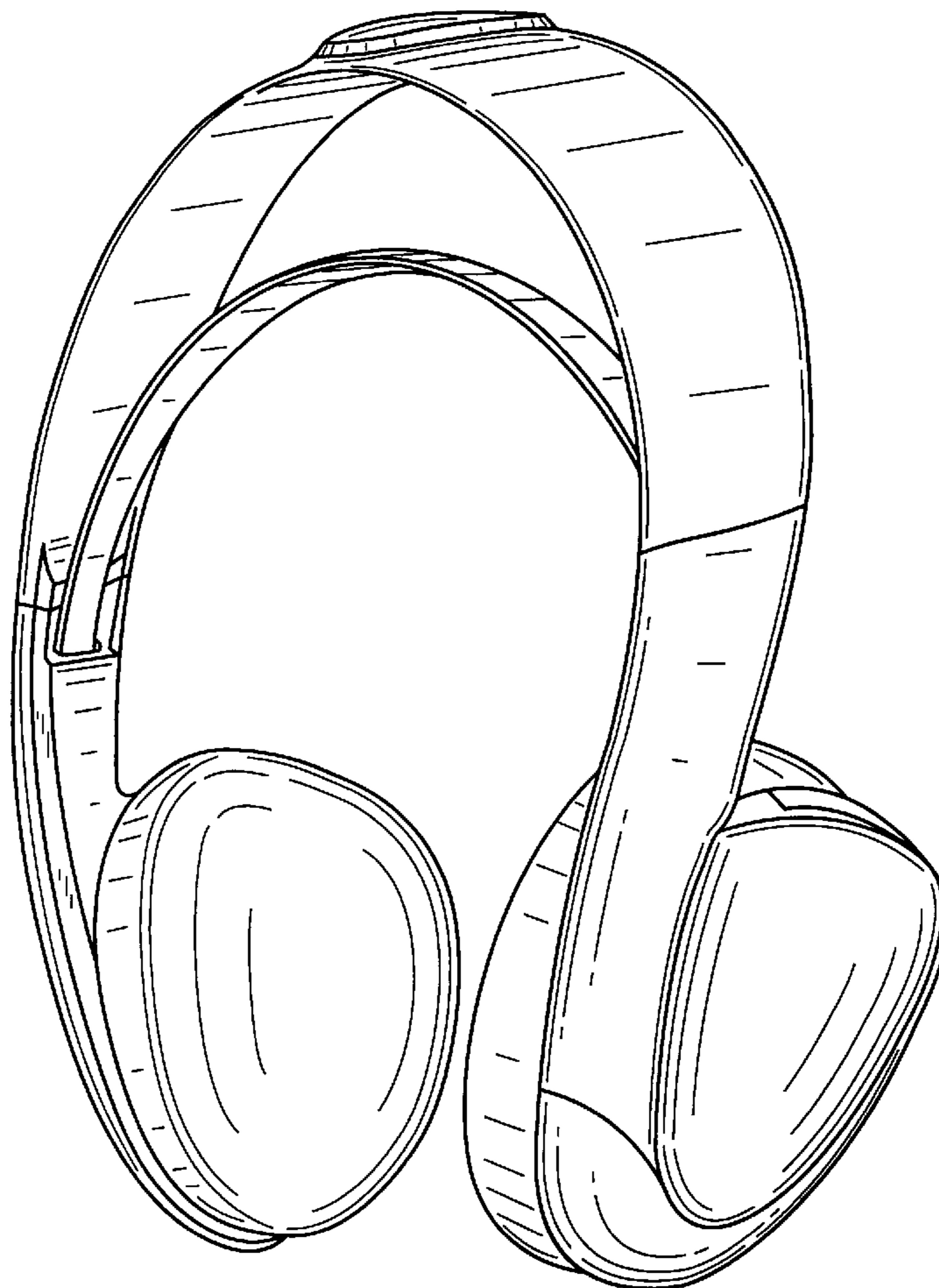

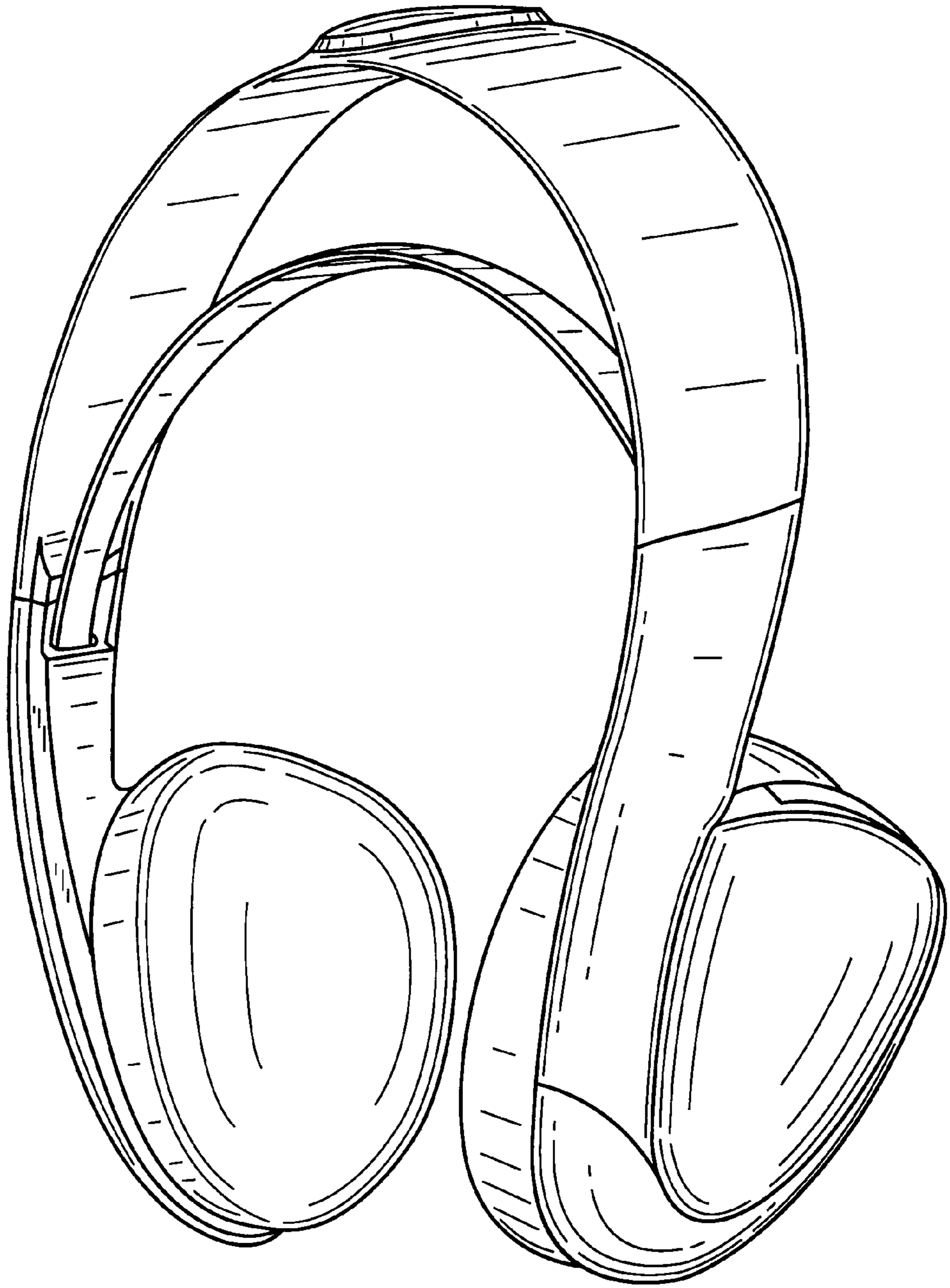

FIG. 1

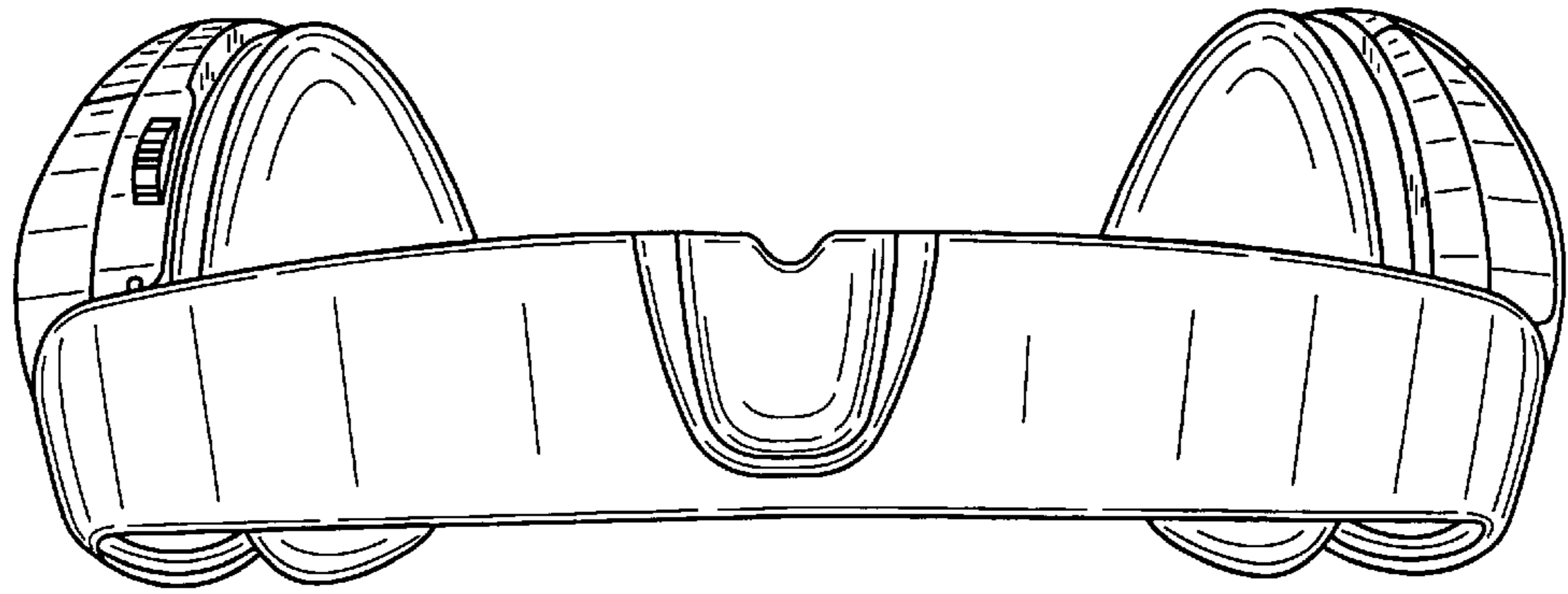

FIG. 2

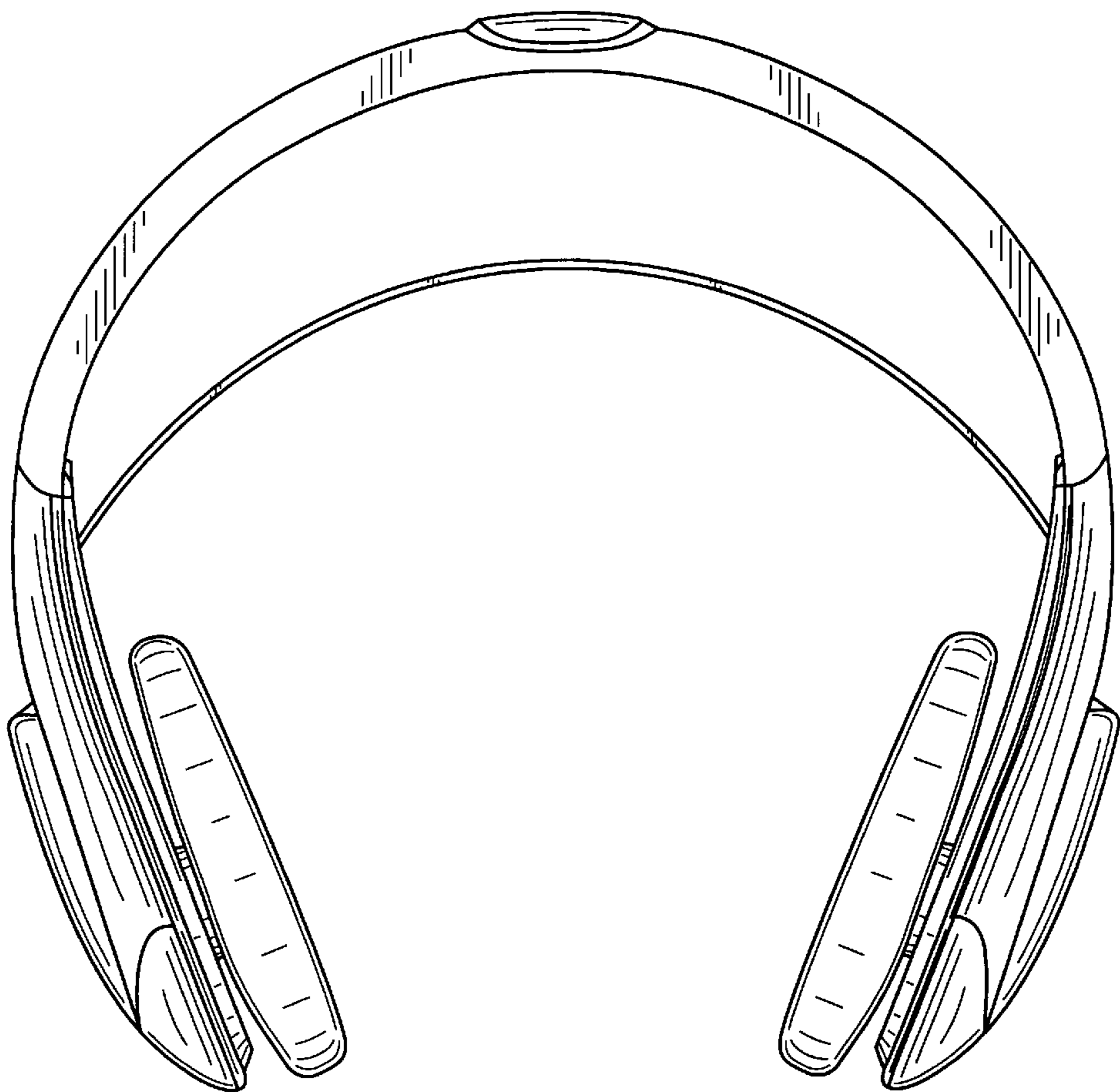

FIG. 3

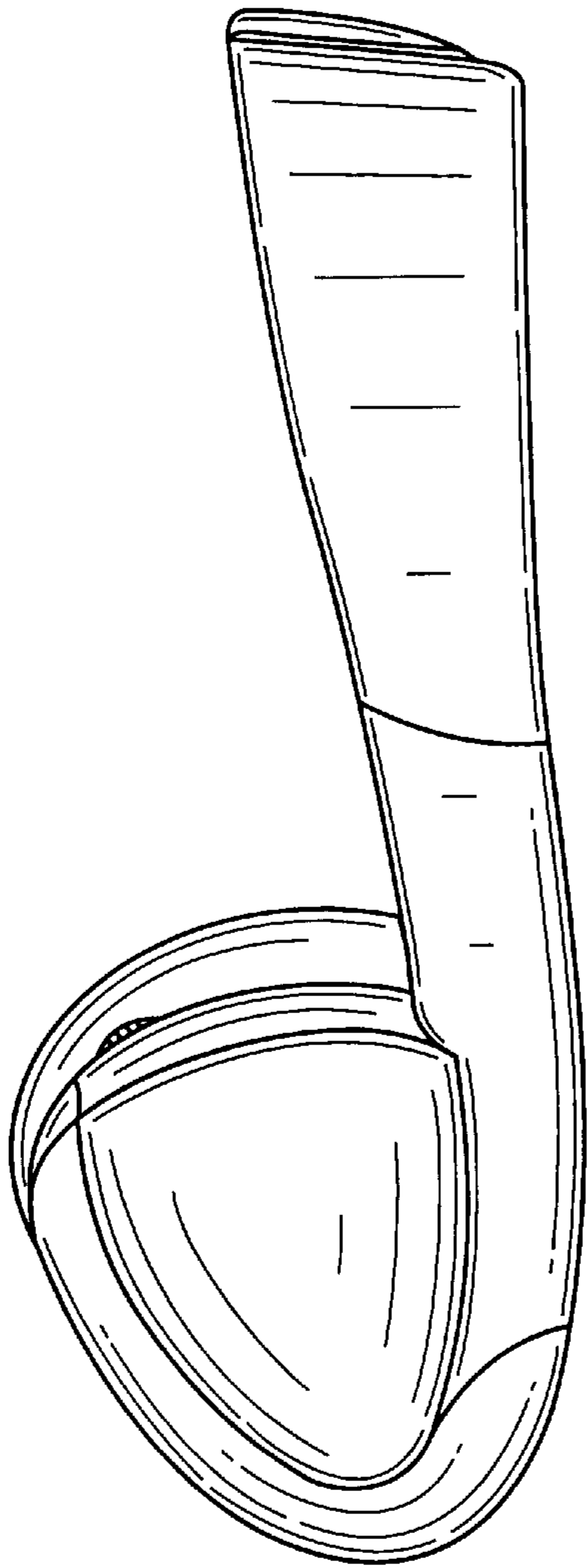

FIG. 4

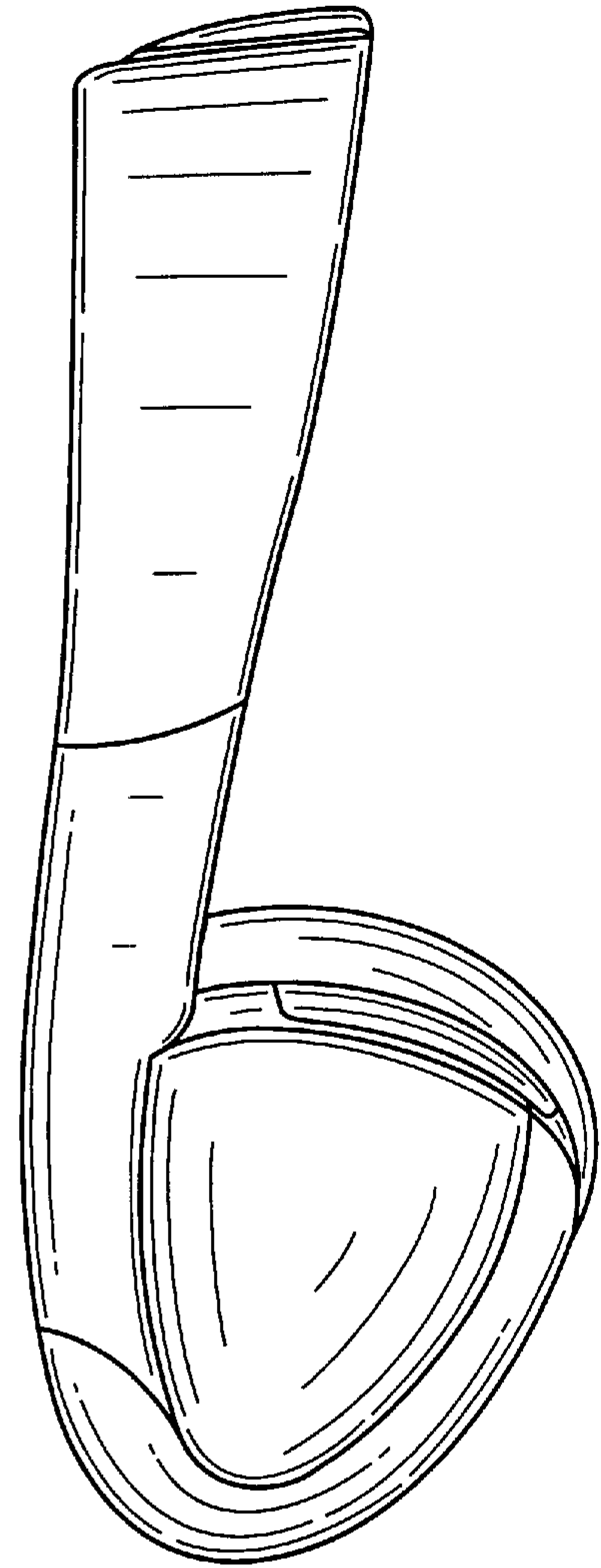

FIG. 5

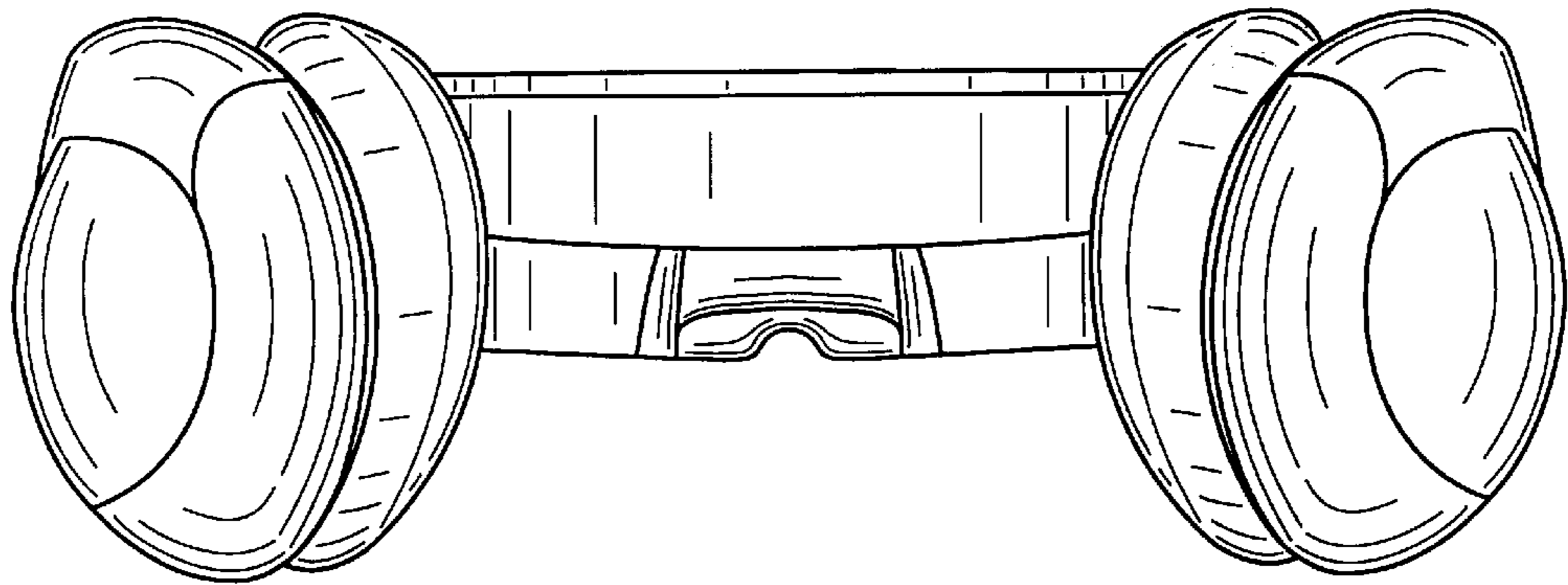

FIG. 6



FIG. 7