



US00D422579S

United States Patent [19]
McBride

[11] **Patent Number: Des. 422,579**

[45] **Date of Patent: ** Apr. 11, 2000**

[54] **VIDEO MONITOR HOOD**

[76] Inventor: **Richard L. McBride**, P.O. Box 67330,
St. Pete Beach, Fla. 36736-7330

[**] Term: **14 Years**

[21] Appl. No.: **29/104,699**

[22] Filed: **May 10, 1999**

[51] **LOC (6) Cl.** **14-02**

[52] **U.S. Cl.** **D14/114**

[58] **Field of Search** D14/114, 113,
D14/239; 359/599-614; 348/832-5; 150/154-168

[56] **References Cited**

U.S. PATENT DOCUMENTS

D. 382,260	8/1997	Smith	D14/114
4,314,280	2/1982	Rose	.	
4,865,420	9/1989	Schmidt	.	
5,069,529	12/1991	Takahashi	.	
5,534,951	7/1996	He	.	
5,717,566	2/1998	Tao	.	

Primary Examiner—M. H. Tung
Attorney, Agent, or Firm—Larson & Larson, P.A.; James E. Larson

[57] **CLAIM**

The ornamental design for a video monitor hood, as shown and described.

DESCRIPTION

FIG. 1 is a perspective view of a video monitor hood showing my new design, on a reduced scale, a portion of the hood is shown broken away for clarity of understanding; FIG. 2 is a top plan view thereof; FIG. 3 is a bottom plan view thereof; FIG. 4 is a right side view thereof; FIG. 5 is a left side view thereof; FIG. 6 is a front side view thereof; and, FIG. 7 is a back side view thereof.

The broken away portion of FIG. 1, that which is a video camera shown separated from the video monitor hood, is for illustrative purposes only and forms no part of the overall claimed design.

1 Claim, 3 Drawing Sheets

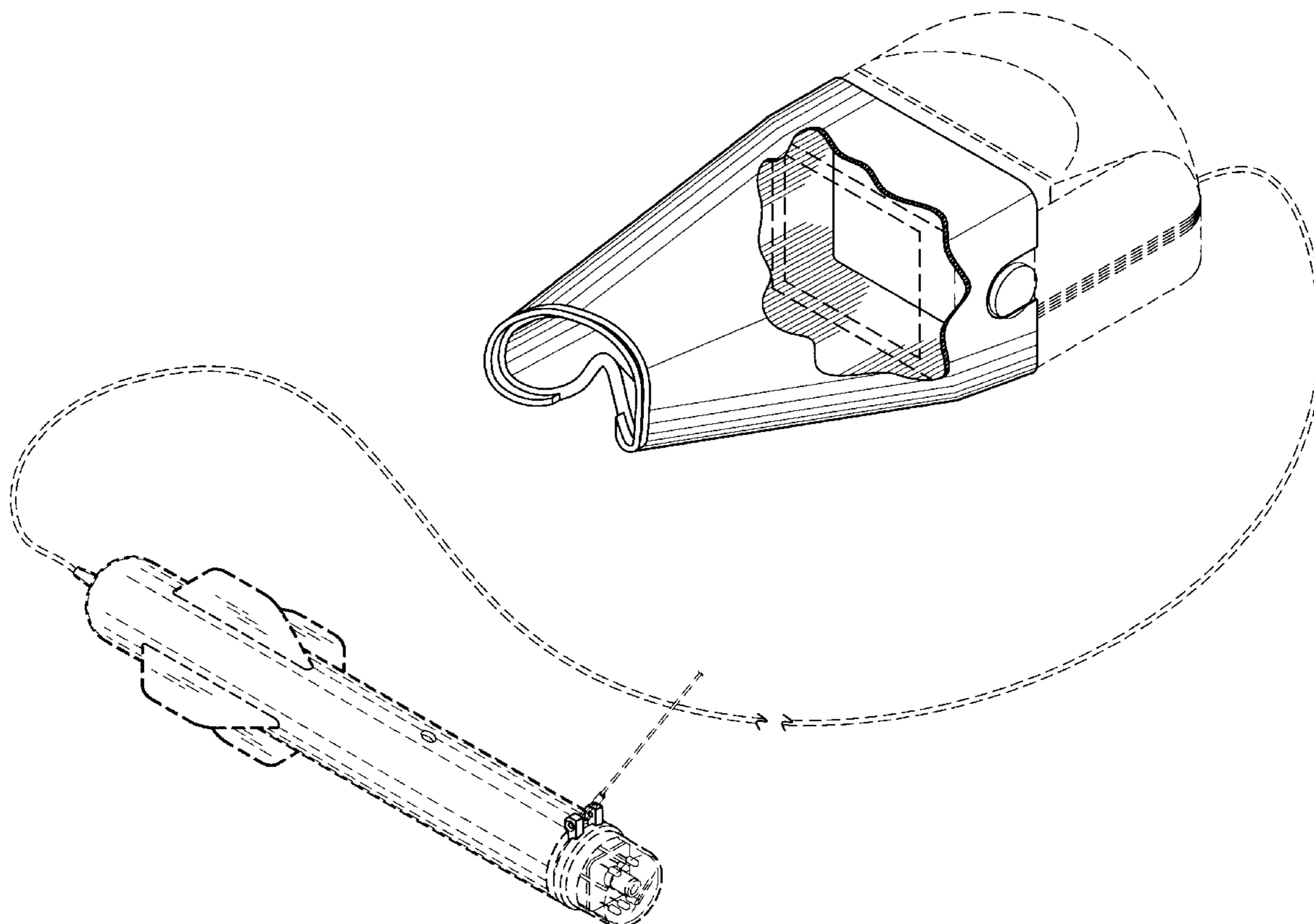

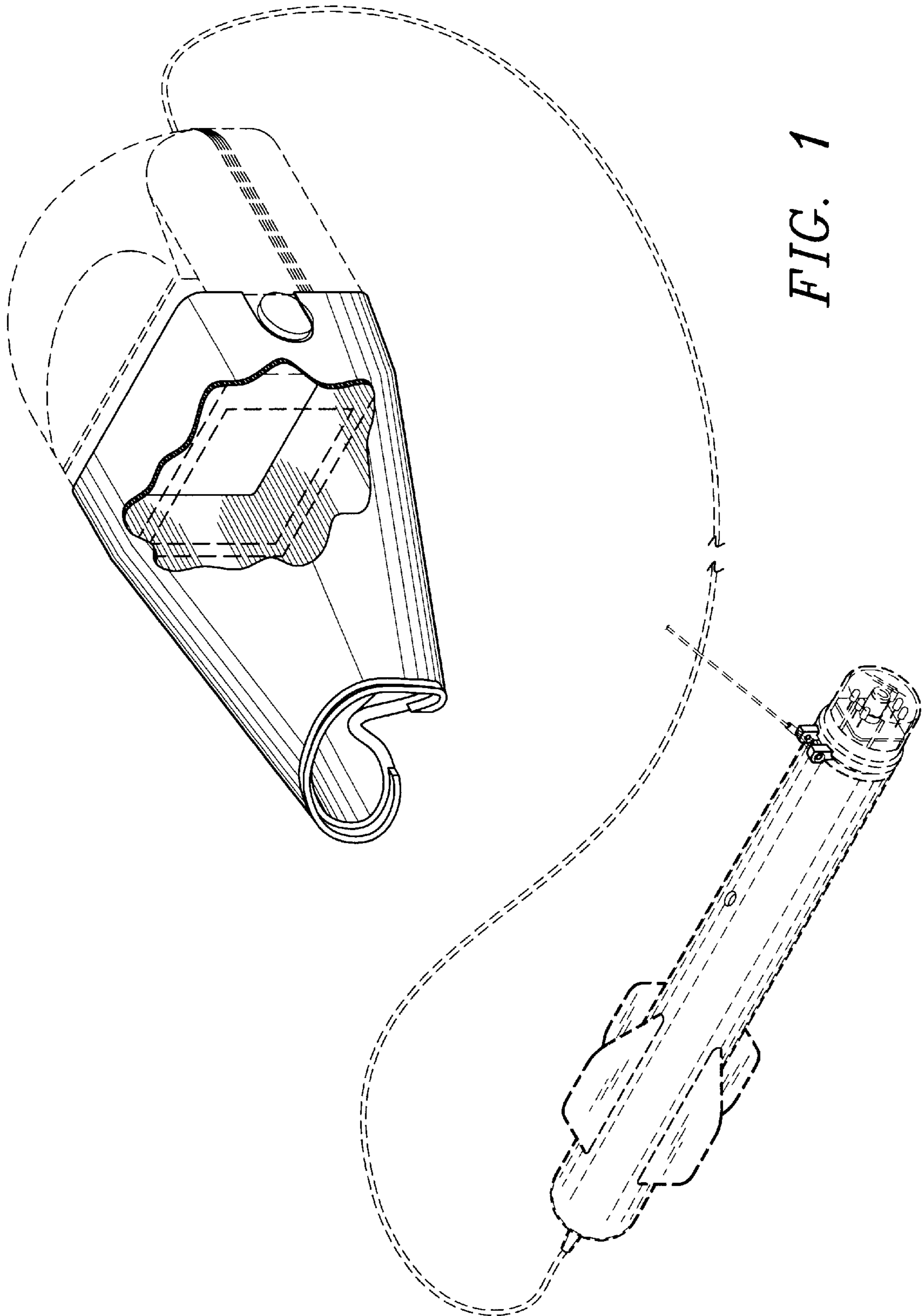

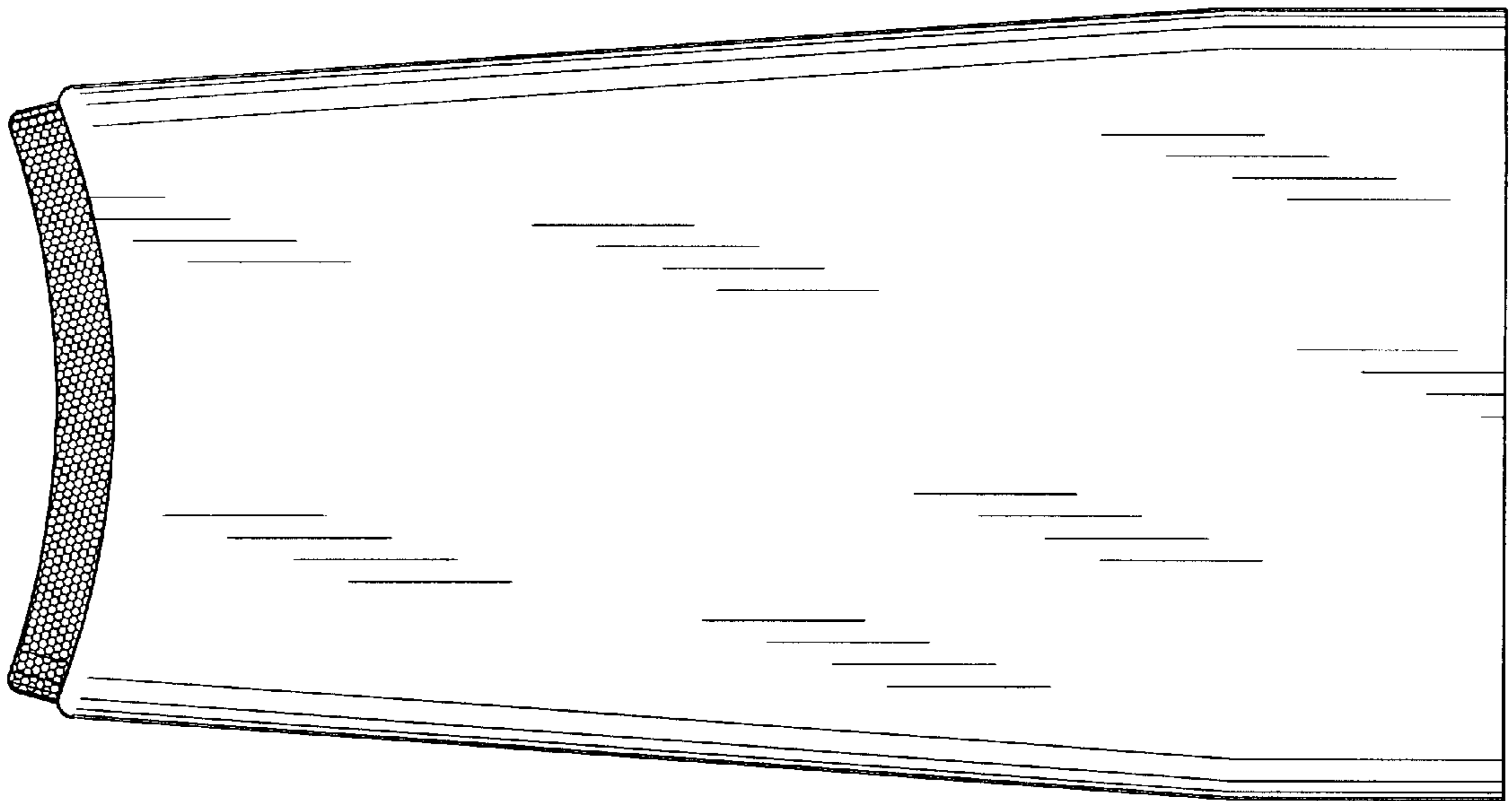

FIG. 2

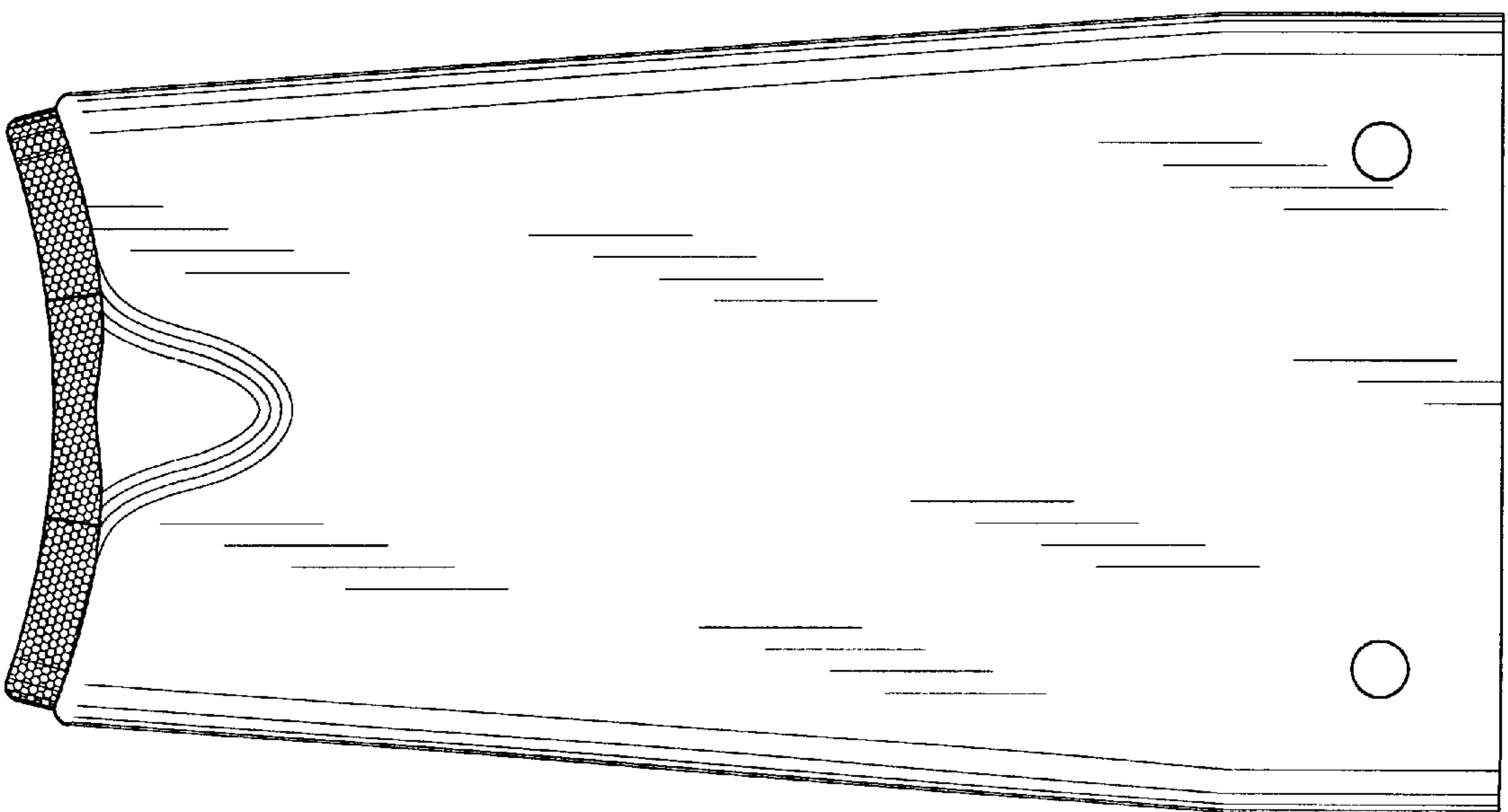

FIG. 3

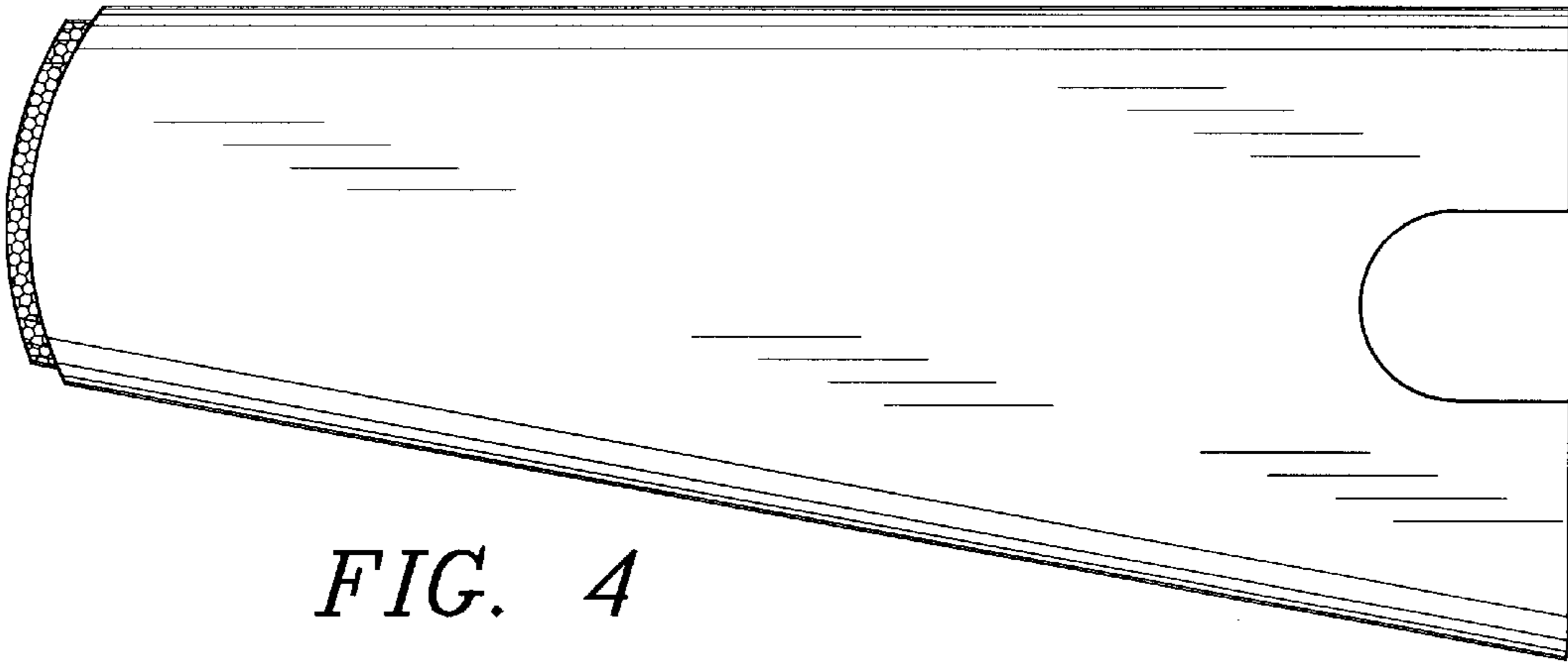

FIG. 4

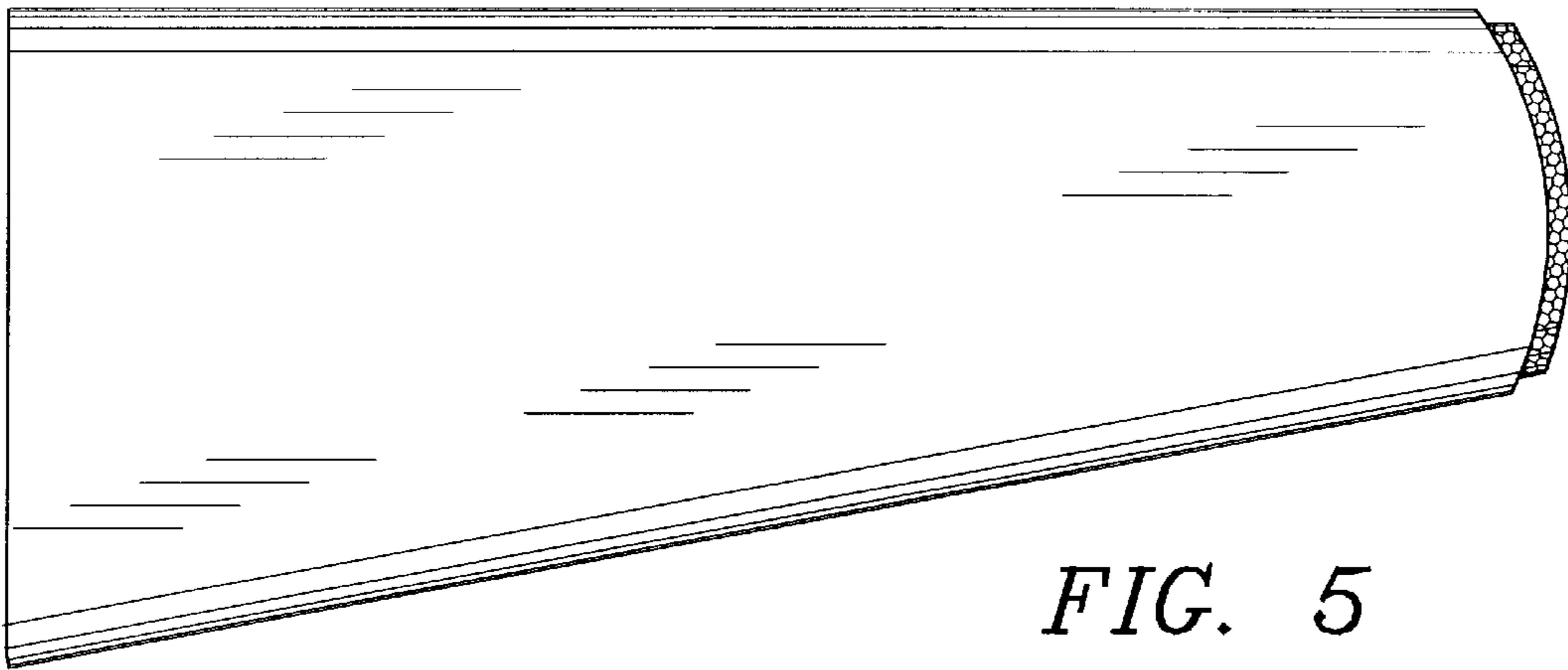

FIG. 5

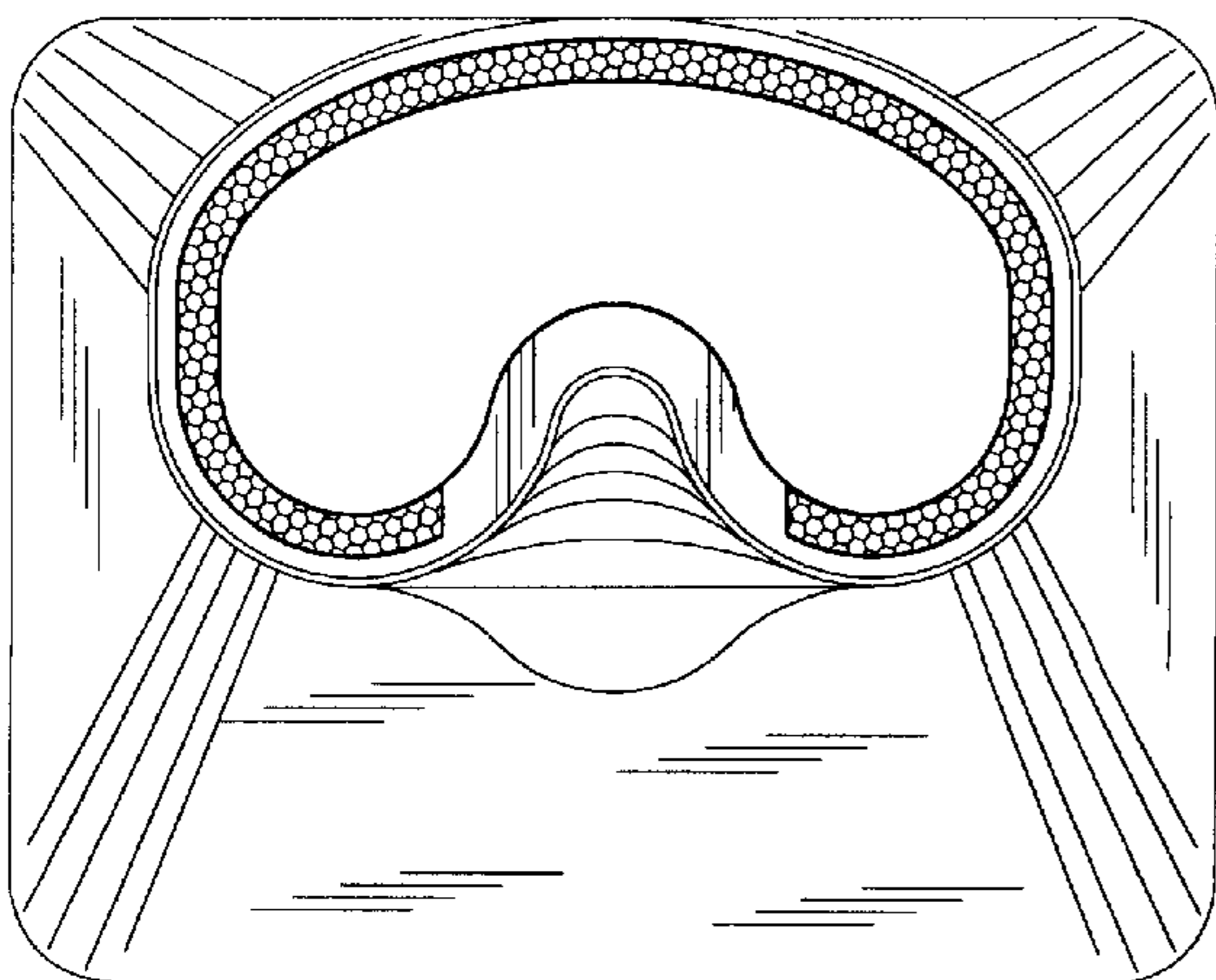

FIG. 6

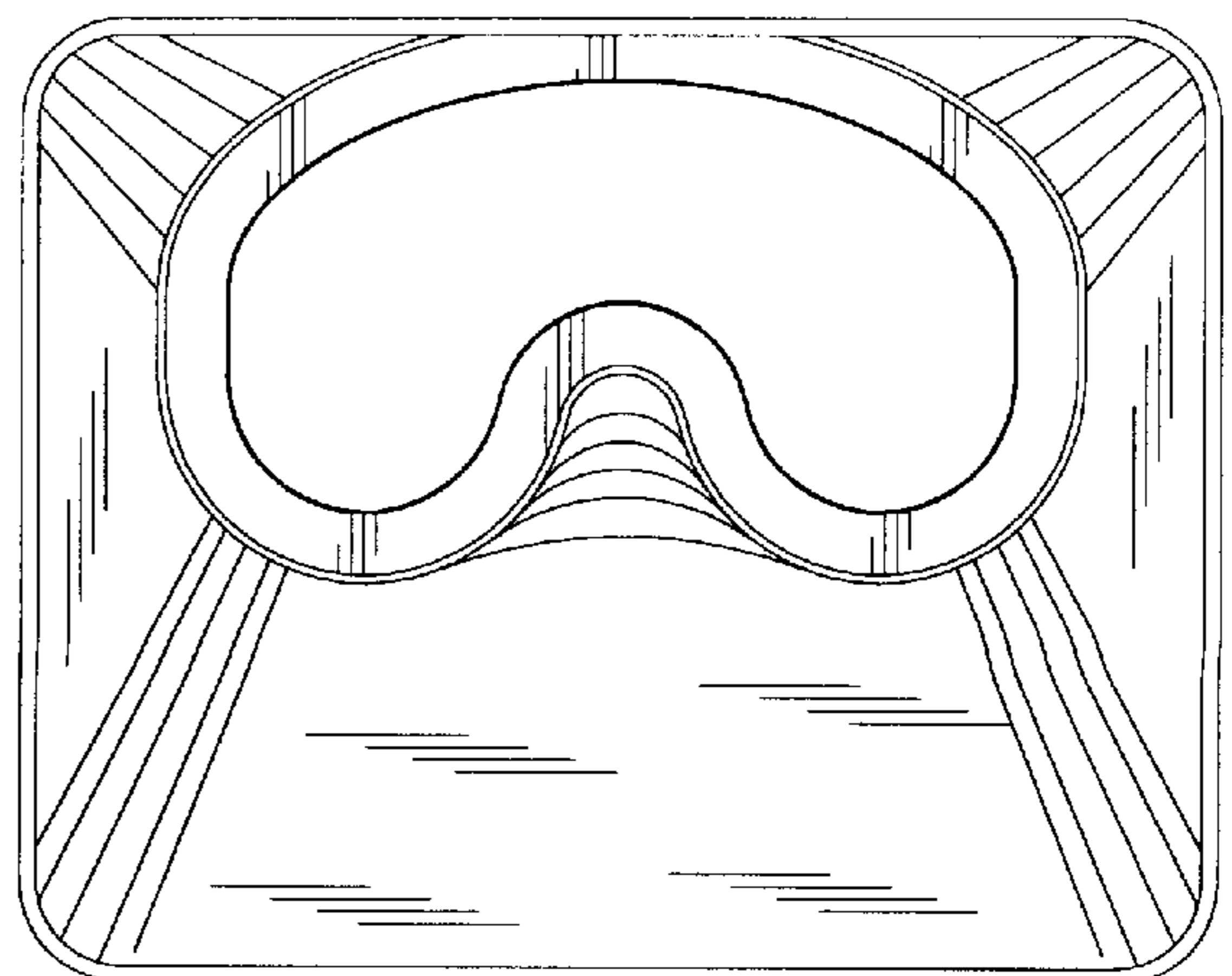

FIG. 7