



US00D422458S

United States Patent [19]
Tate

[11] **Patent Number: Des. 422,458**

[45] **Date of Patent: ** Apr. 11, 2000**

[54] **GOLF BALL AND PUTTER/WINE BOTTLE MOUNT**

[76] Inventor: **John R. Tate**, 11621 Markon Dr., Garden Grove, Calif. 92841

[**] Term: **14 Years**

[21] Appl. No.: **29/101,459**

[22] Filed: **Mar. 2, 1999**

[51] **LOC (6) Cl.** **07-06**

[52] **U.S. Cl.** **D7/619; D21/796**

[58] **Field of Search** **D7/619; D6/469; D21/796; 211/74, 13.1; 248/146, 148, 133, 152, 312**

[56] **References Cited**

U.S. PATENT DOCUMENTS

| | | | | |
|------------|--------|---------|-------|---------|
| D. 329,781 | 9/1992 | Ito | | D7/619 |
| D. 377,885 | 2/1997 | Knapton | | D7/619 |
| 4,496,124 | 1/1985 | Cole | | 248/146 |

Primary Examiner—Terry A. Wallace
Attorney, Agent, or Firm—Charles H. Thomas

[57] **CLAIM**

The ornamental design for a golf ball and putter/wine bottle mount, as shown and described.

DESCRIPTION

FIG. 1 is a perspective view of a golf ball and putter/wine bottle mount showing my new design, the ball marker that is insertable in the disc-shaped recess being shown for purposes of reference of position and in phantom and forming no part of this new design;

FIG. 2 is a right-side elevational view showing my new design, the golf putter and golf ball inserted therein being shown for purposes of reference of position and in phantom and forming no part of this new design;

FIG. 3 is a top plan view thereof;

FIG. 4 is a left-side elevational view showing my new design, the wine bottle and golf ball inserted therein being shown for purposes of reference of position and in phantom and forming no part of this new design;

FIG. 5 is a front elevational view thereof;

FIG. 6 is a rear elevational view thereof; and,

FIG. 7 is a bottom plan view thereof.

1 Claim, 5 Drawing Sheets

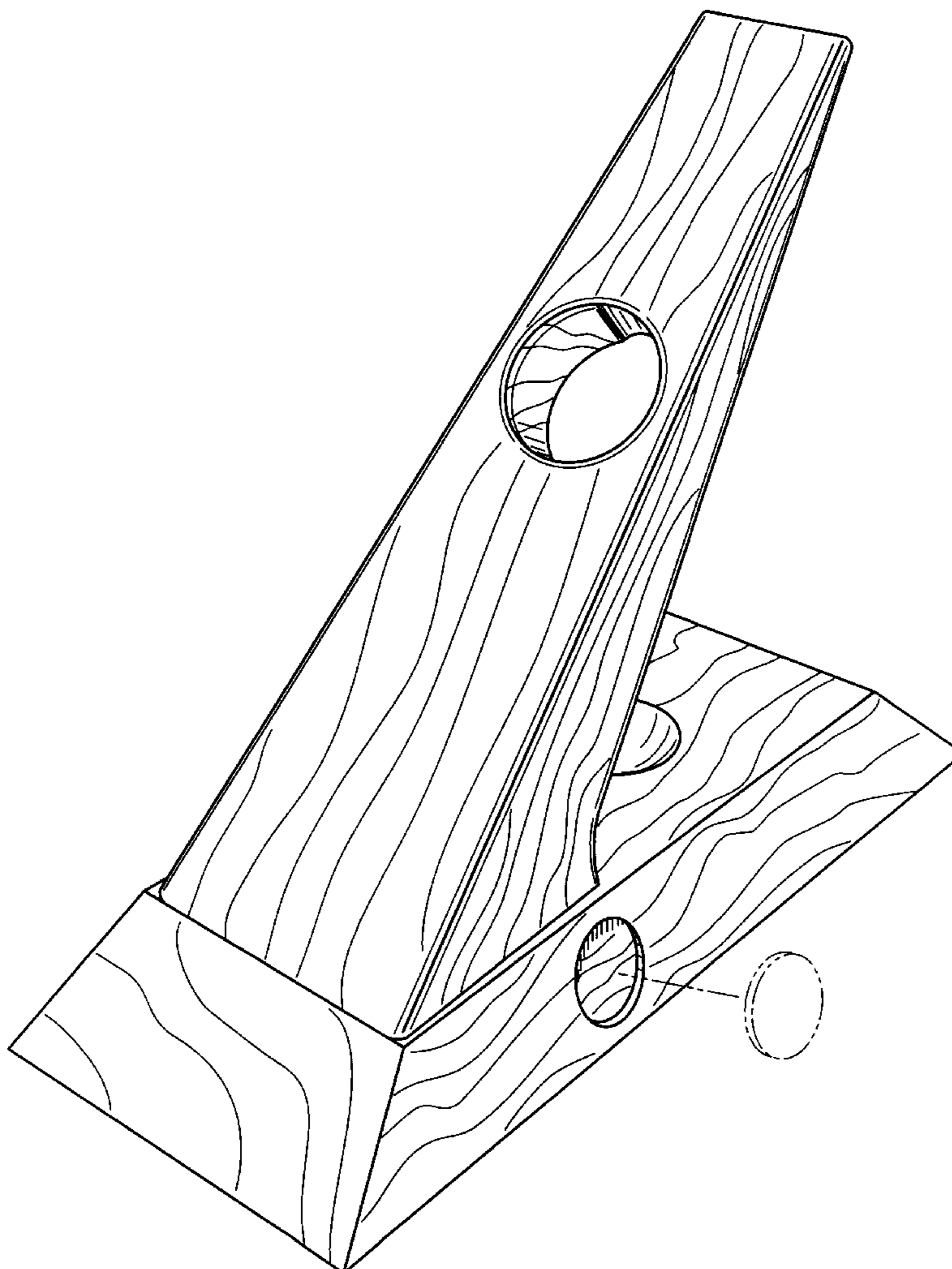

FIG. 1

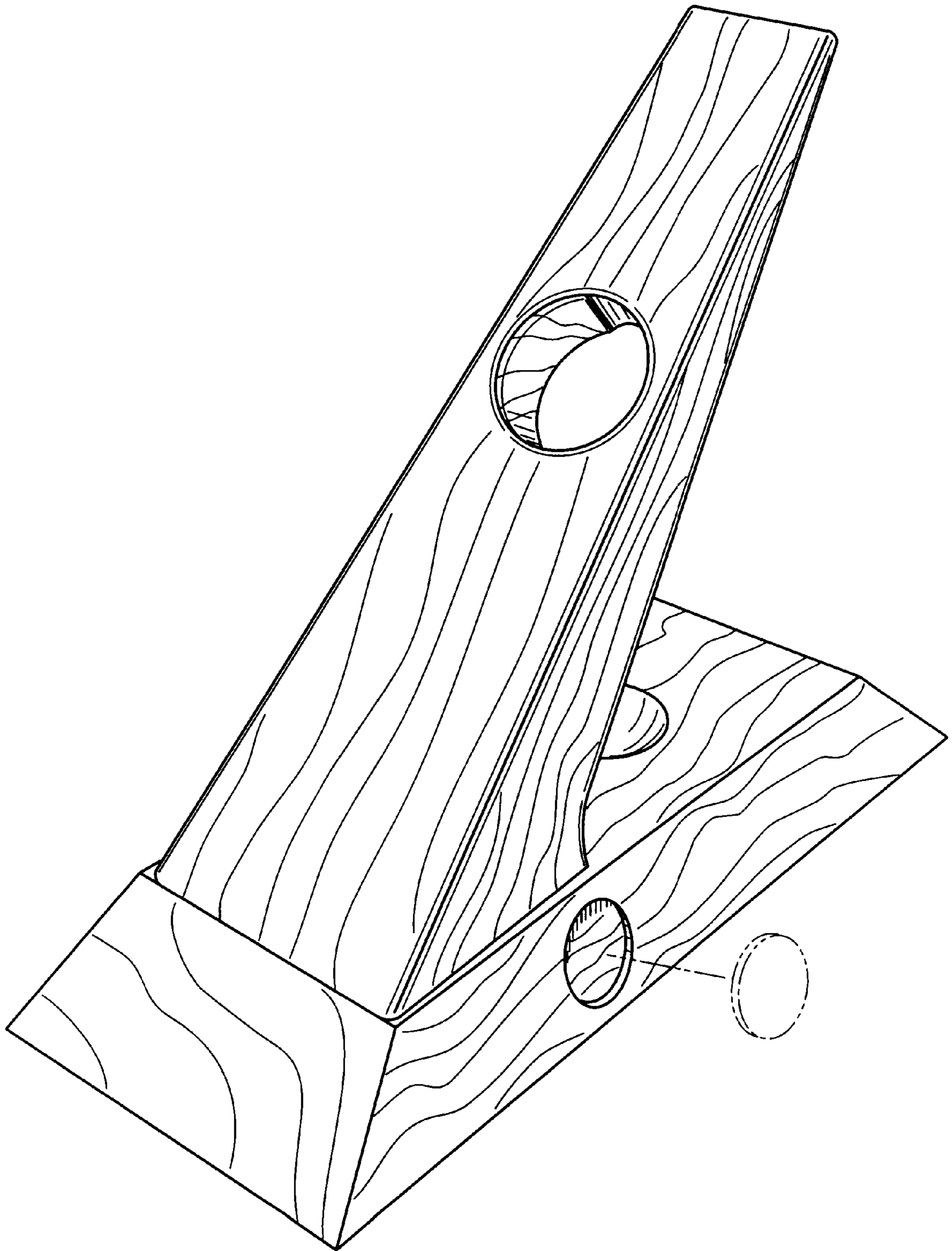

FIG. 2

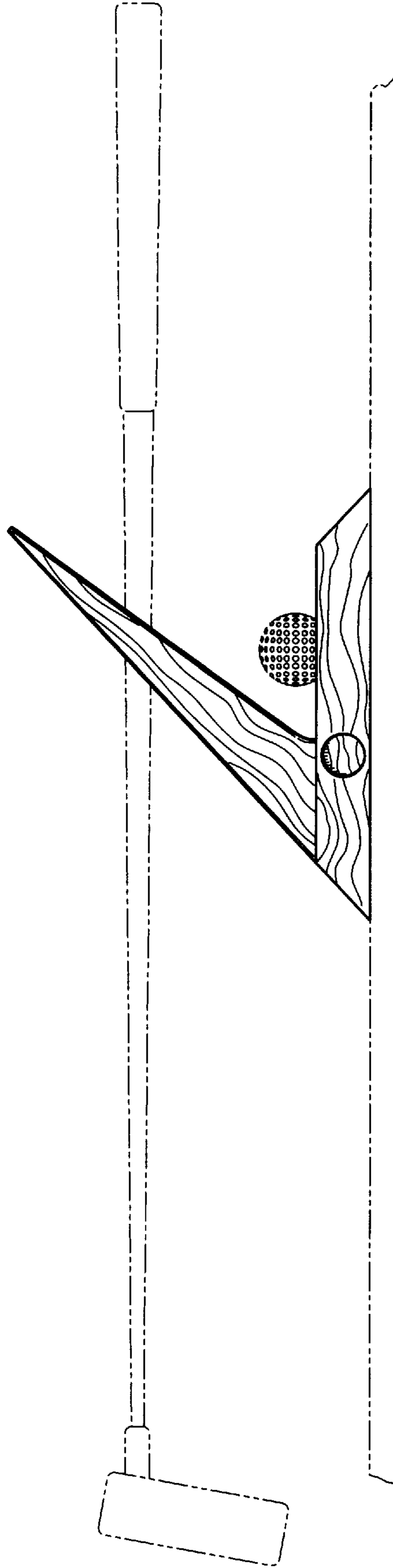

FIG. 3

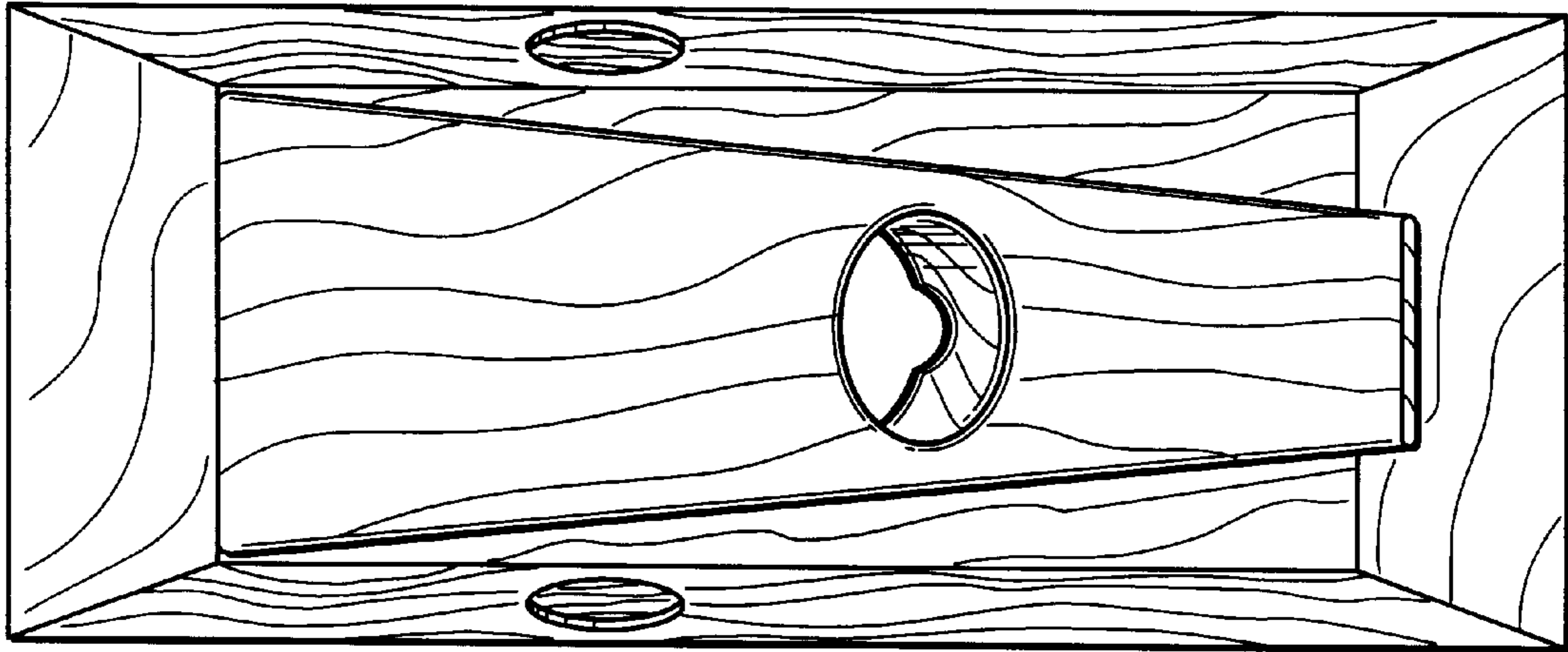
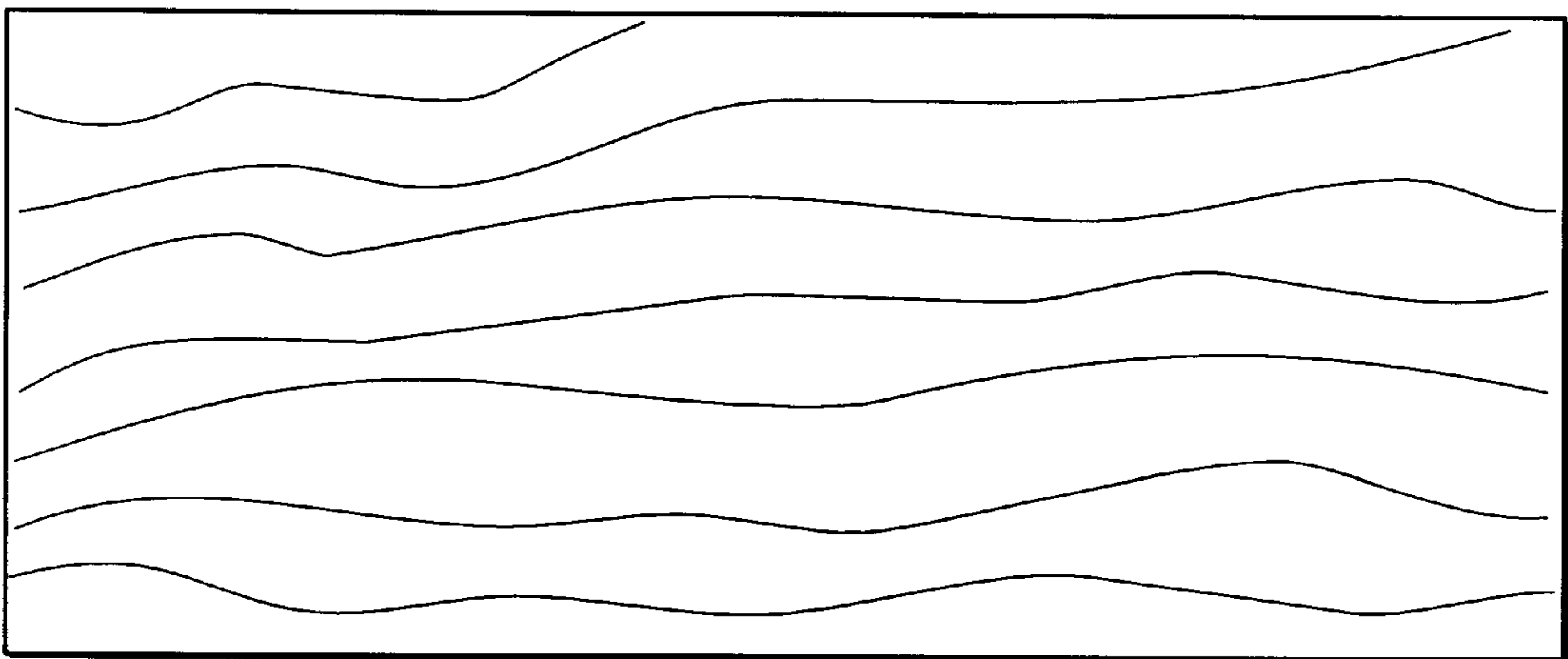

FIG. 7



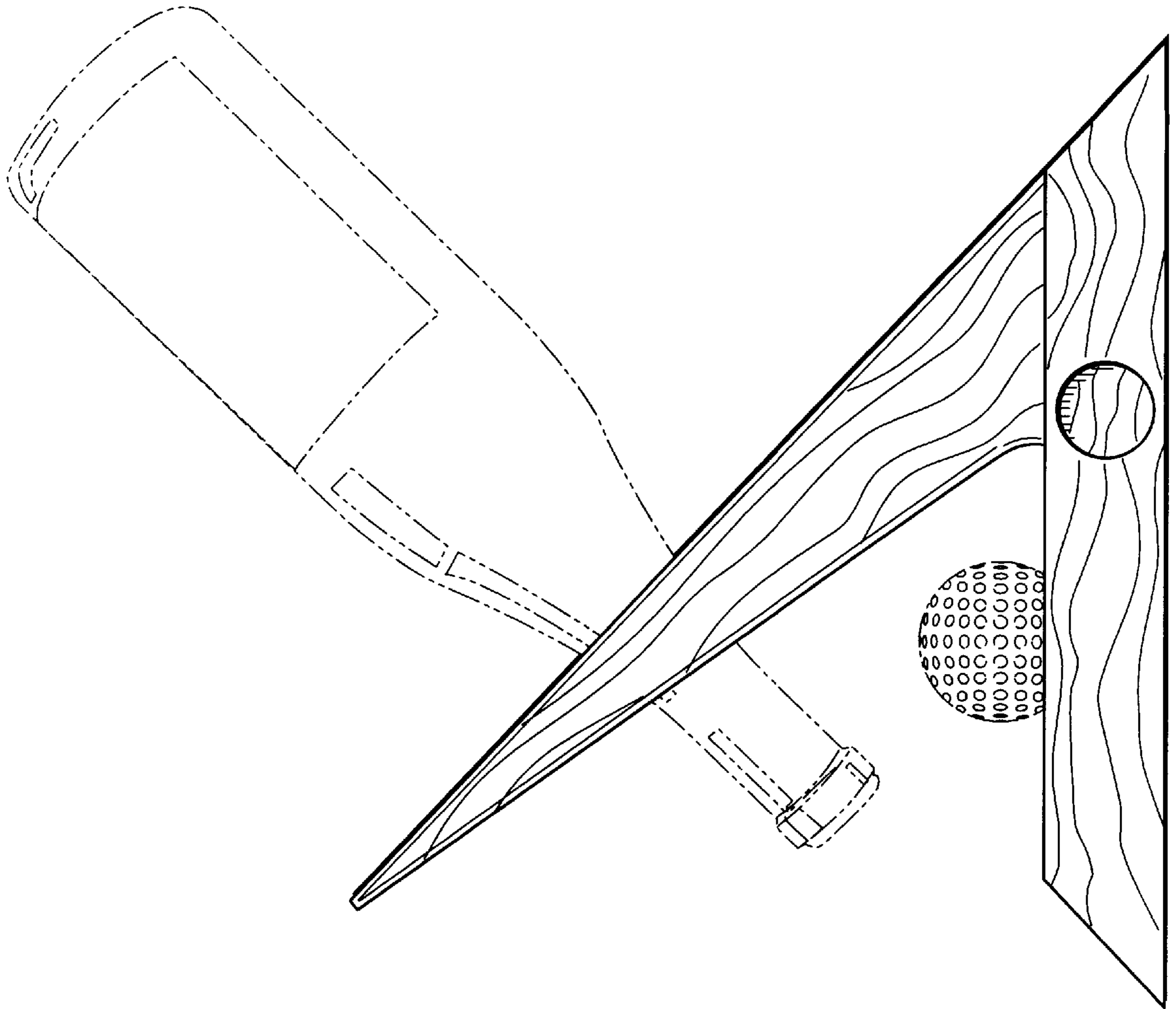

FIG. 4

FIG. 6

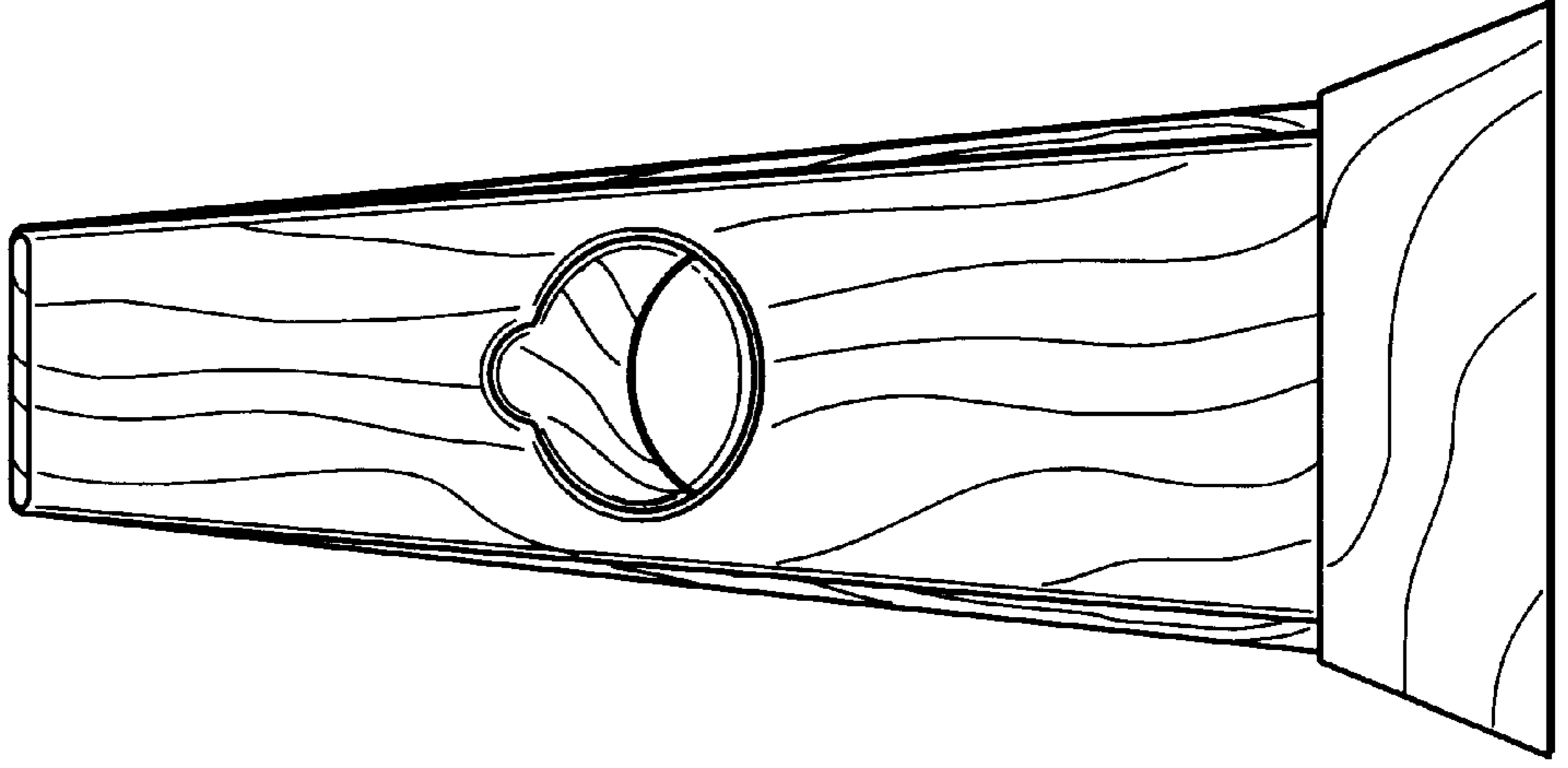

FIG. 5

