



US00D422375S

**United States Patent** [19]  
**Milicia**

[11] **Patent Number: Des. 422,375**  
[45] **Date of Patent: \*\* Apr. 4, 2000**

[54] **LIGHTING FIXTURE**

[75] Inventor: **Libbe A. Milicia**, North Royalton, Ohio

[73] Assignee: **The L.D. Kichler Co.**, Cleveland, Ohio

[\*\*] Term: **14 Years**

[21] Appl. No.: **29/094,685**

[22] Filed: **Oct. 7, 1998**

[51] **LOC (6) Cl.** ..... **26-05**

[52] **U.S. Cl.** ..... **D26/88**

[58] **Field of Search** ..... D26/72, 80-92,  
D26/142, 143, 144, 145, 146, 155; 362/432,  
147

[56] **References Cited**

**U.S. PATENT DOCUMENTS**

D. 380,578 7/1997 Visage et al. .

**OTHER PUBLICATIONS**

Corbett lighting catalog, p. 19, lighting fixture # 765, Jan. 1992.

Elgee lighting catalog, p. 16, lighting fixture # 368-PB, Jan. 1991.

*Primary Examiner*—Susan J. Lucas

*Attorney, Agent, or Firm*—Watts, Hoffmann, Fisher & Heinke, Co., L.P.A.

[57] **CLAIM**

I claim the ornamental design for a lighting fixture, as shown and described.

**DESCRIPTION**

FIG. 1 is a perspective view of the lighting fixture showing my new design;

FIG. 2 is a left side elevational view of the lighting fixture;

FIG. 3 is a right side elevational view of the lighting fixture;

FIG. 4 is a front elevational view of the lighting fixture, the rear elevational view being a mirror image;

FIG. 5 is a top plan view of the lighting fixture; and,

FIG. 6 is a bottom plan view of the lighting fixture.

The broken lines shown are for illustrative purposes only and forms no part of the claimed design.

**1 Claim, 5 Drawing Sheets**

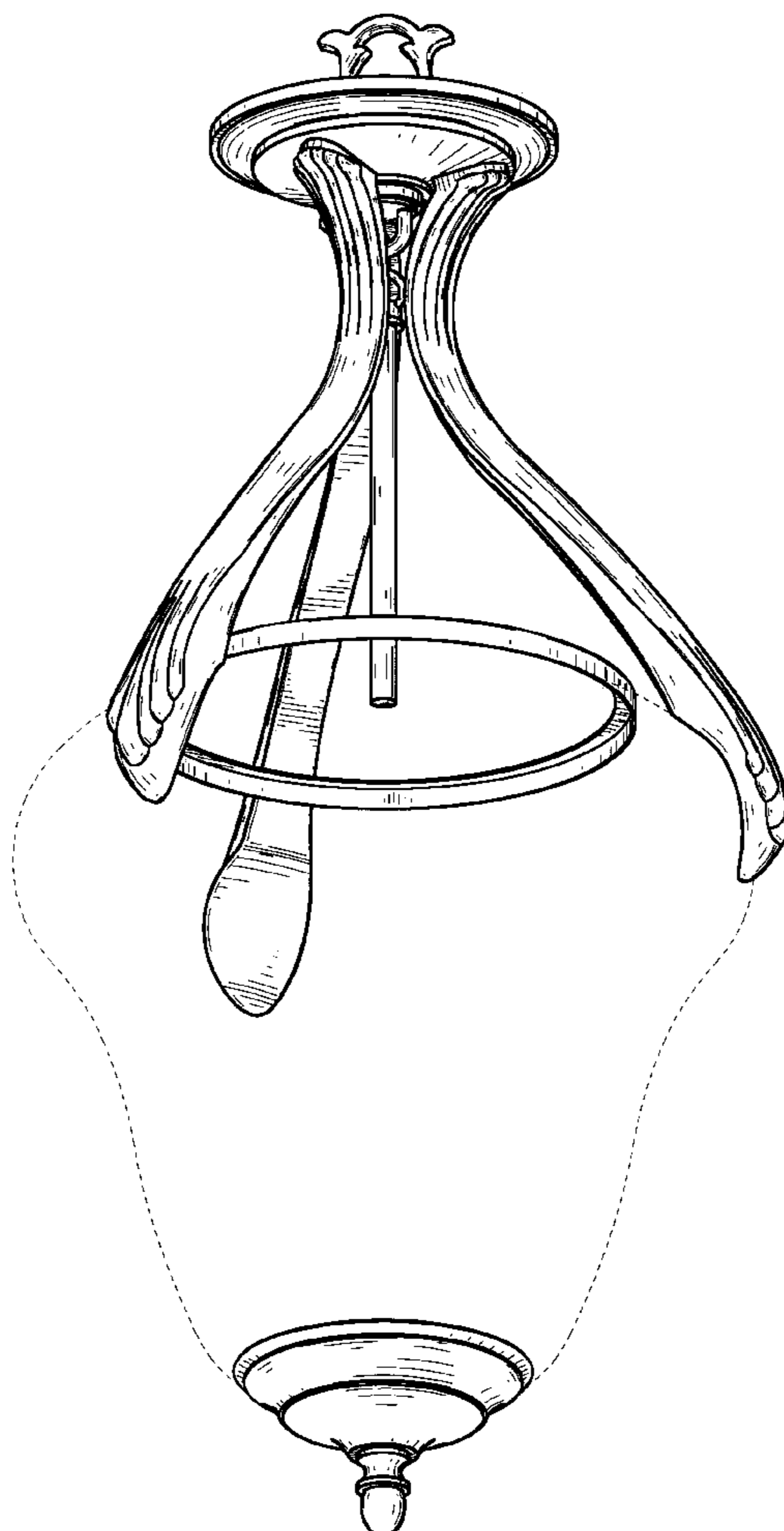

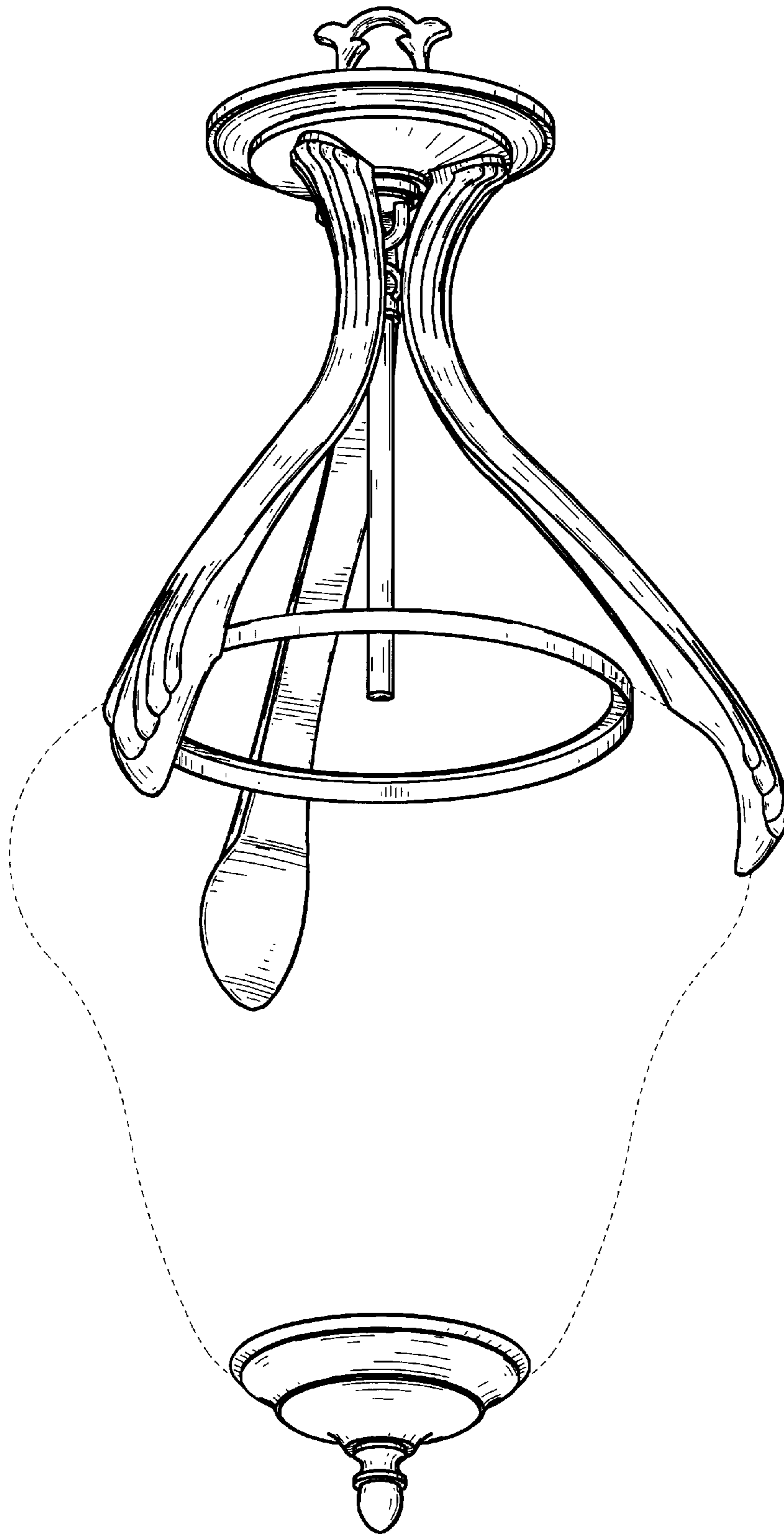

Fig.1

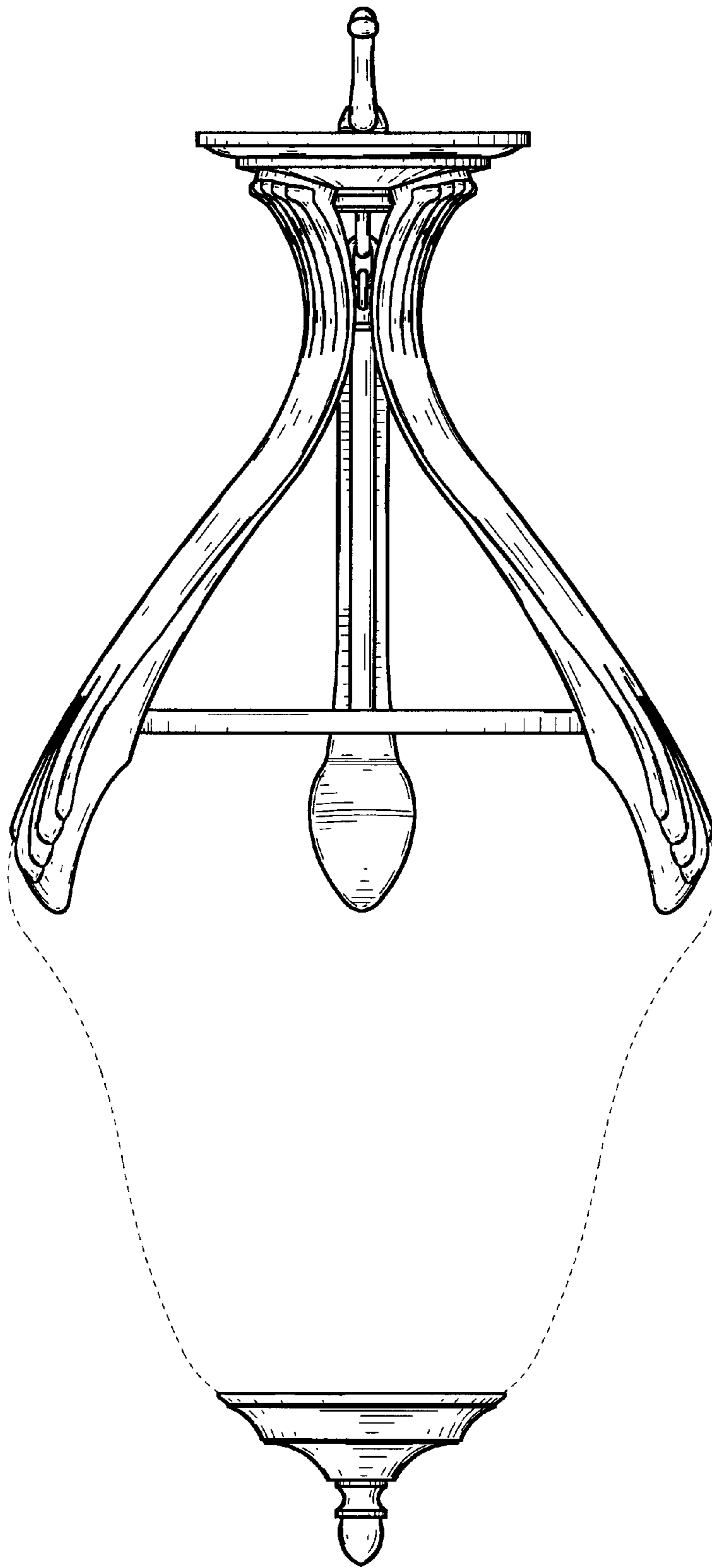

Fig.2

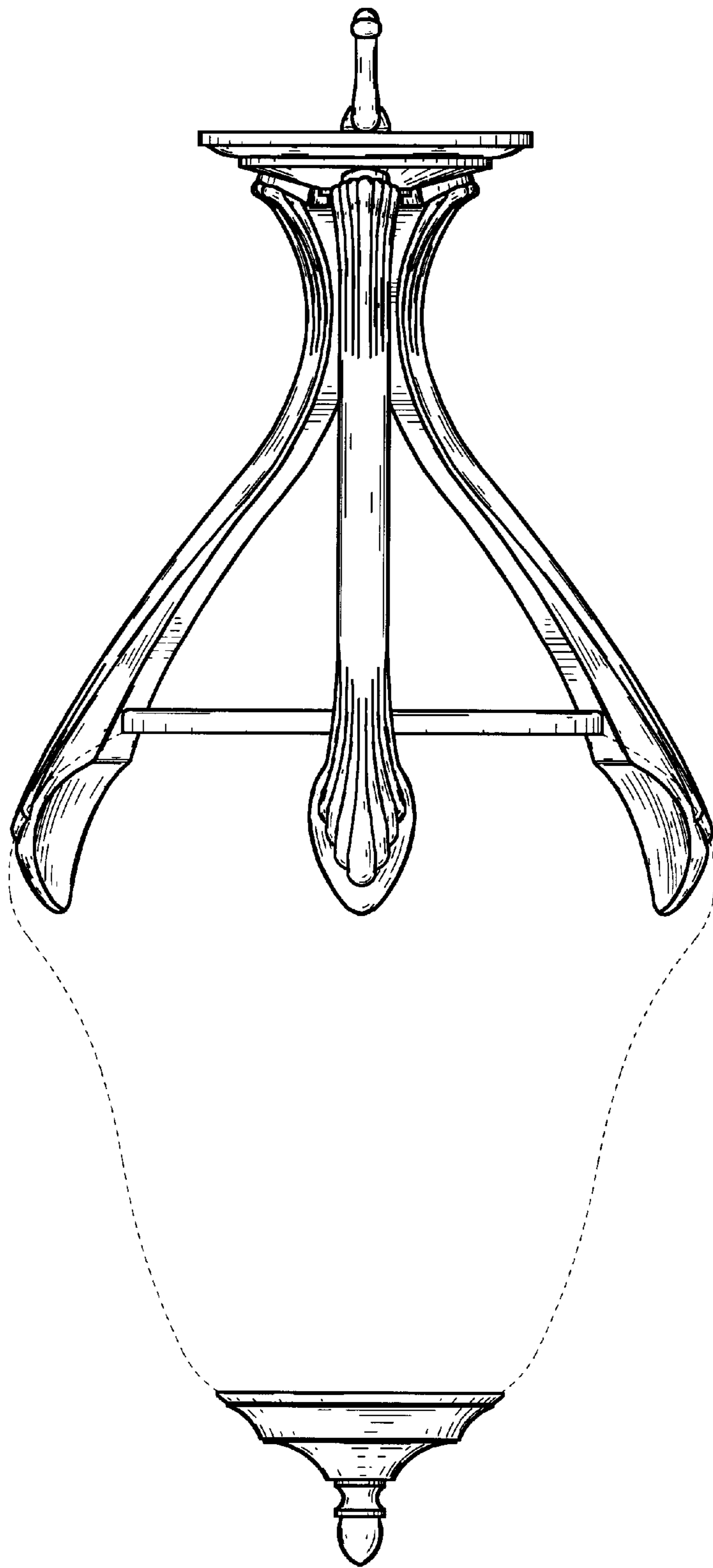

Fig.3

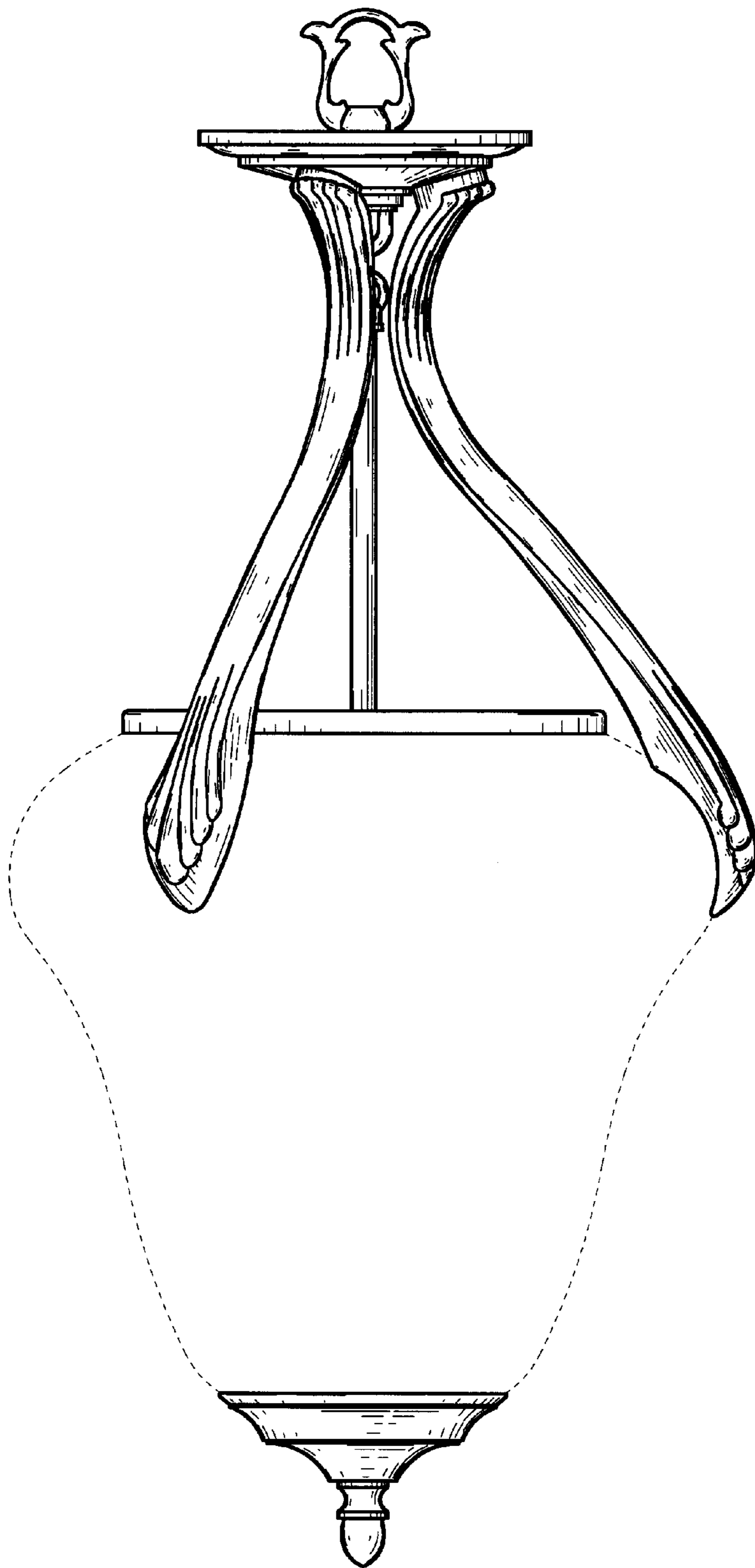

Fig.4



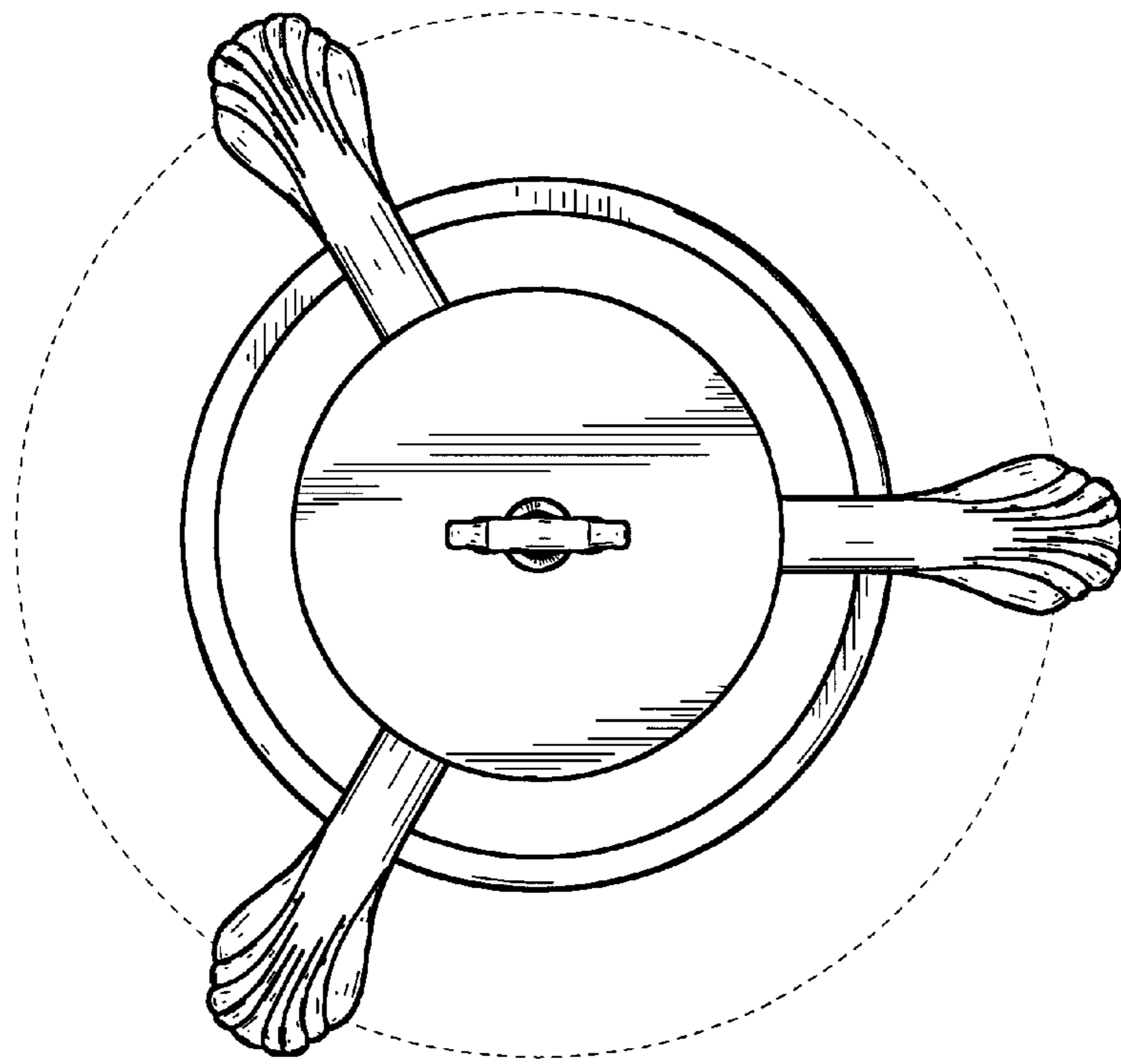

Fig.5

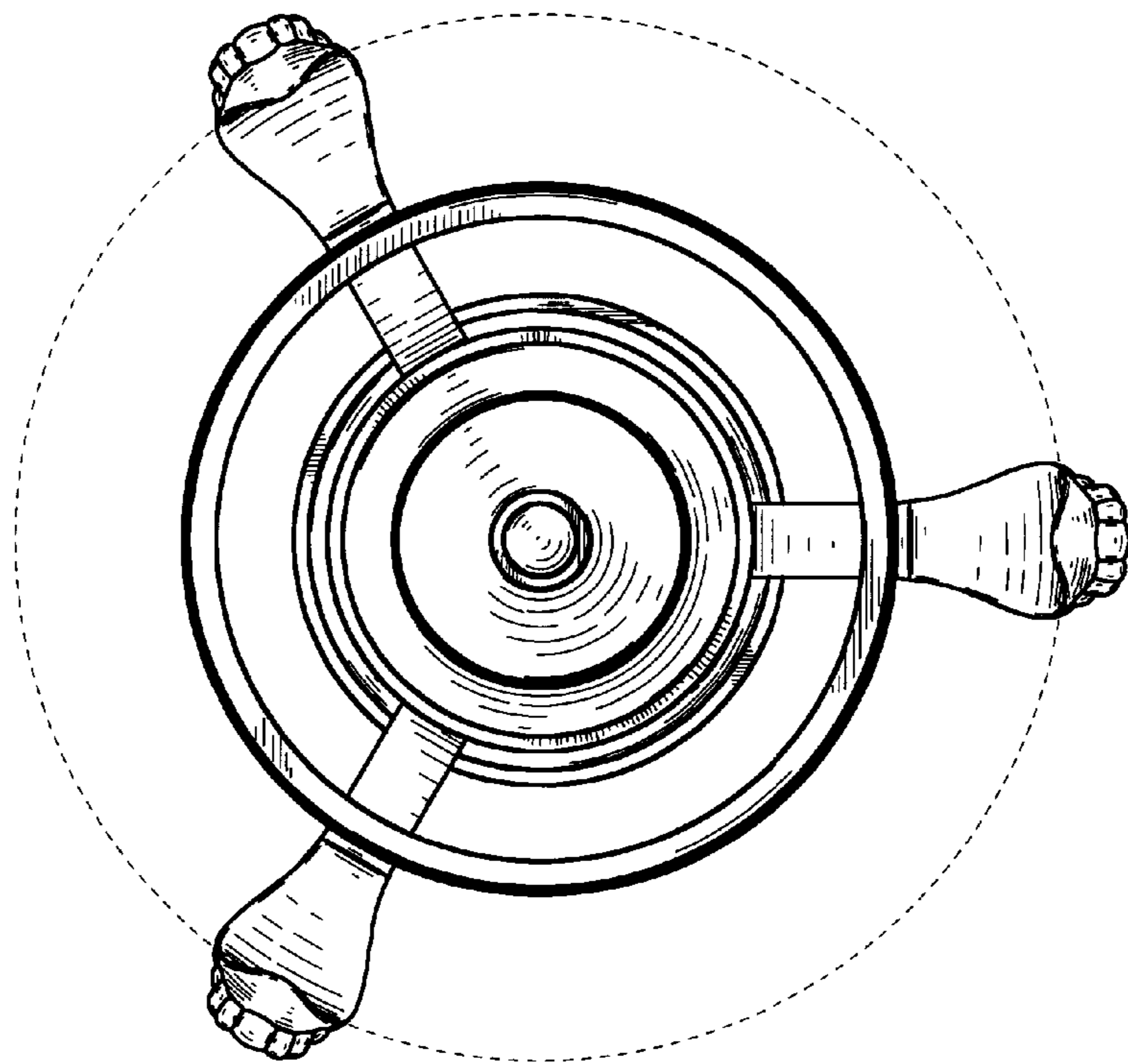

Fig.6