



US00D422364S

United States Patent [19]

Van Dyk et al.

[11] Patent Number: Des. 422,364

[45] Date of Patent: ** Apr. 4, 2000

[54] MASSAGER

D. 391,645 3/1998 Chien D24/211
4,157,712 6/1979 Gaynor 601/125

[75] Inventors: **Thomas Charles Van Dyk**, Ramsey;
Michael Patrick Ballone, New
Providence, both of N.J.; **Morris Gary
Grossman**, Riverside, Conn.

Primary Examiner—Stella Reid
Attorney, Agent, or Firm—Brinks Hofer Gilson & Lione

[73] Assignee: **The Rival Company**, Kansas City, Mo.

[57] CLAIM

[**] Term: **14 Years**

The ornamental design for a massager, as shown and described.

[21] Appl. No.: **29/089,158**

DESCRIPTION

[22] Filed: **Jun. 9, 1998**

FIG. 1 is a perspective view of a massager showing our new design;

[51] LOC (6) Cl. **24-04**

FIG. 2 is a left side view thereof;

[52] U.S. Cl. **D24/211; D24/214**

FIG. 3 is a top view thereof;

[58] Field of Search D24/211, 214,
D24/200; 601/118, 122, 126, 128, 129,
130, 131, 134-137

FIG. 4 is a front view thereof;

FIG. 5 is a bottom view thereof; and

FIG. 6 is a rear view thereof;

FIG. 7 is a perspective view of a second embodiment of a massager showing our new design

FIG. 8 is a left side view thereof;

FIG. 9 is a top view thereof; and

FIG. 10 is a front view thereof.

The bottom and the rear of FIG. 7 is identical to that shown for FIGS. 5 and 6.

[56] References Cited

U.S. PATENT DOCUMENTS

D. 206,512	12/1966	Waldeck	D24/211
D. 262,490	12/1981	Hewitt	D24/211
D. 273,042	3/1984	Jackson	D24/211
D. 314,799	2/1991	Takahashi et al.	D24/211 X
D. 347,477	5/1994	Morales	D24/211

1 Claim, 5 Drawing Sheets

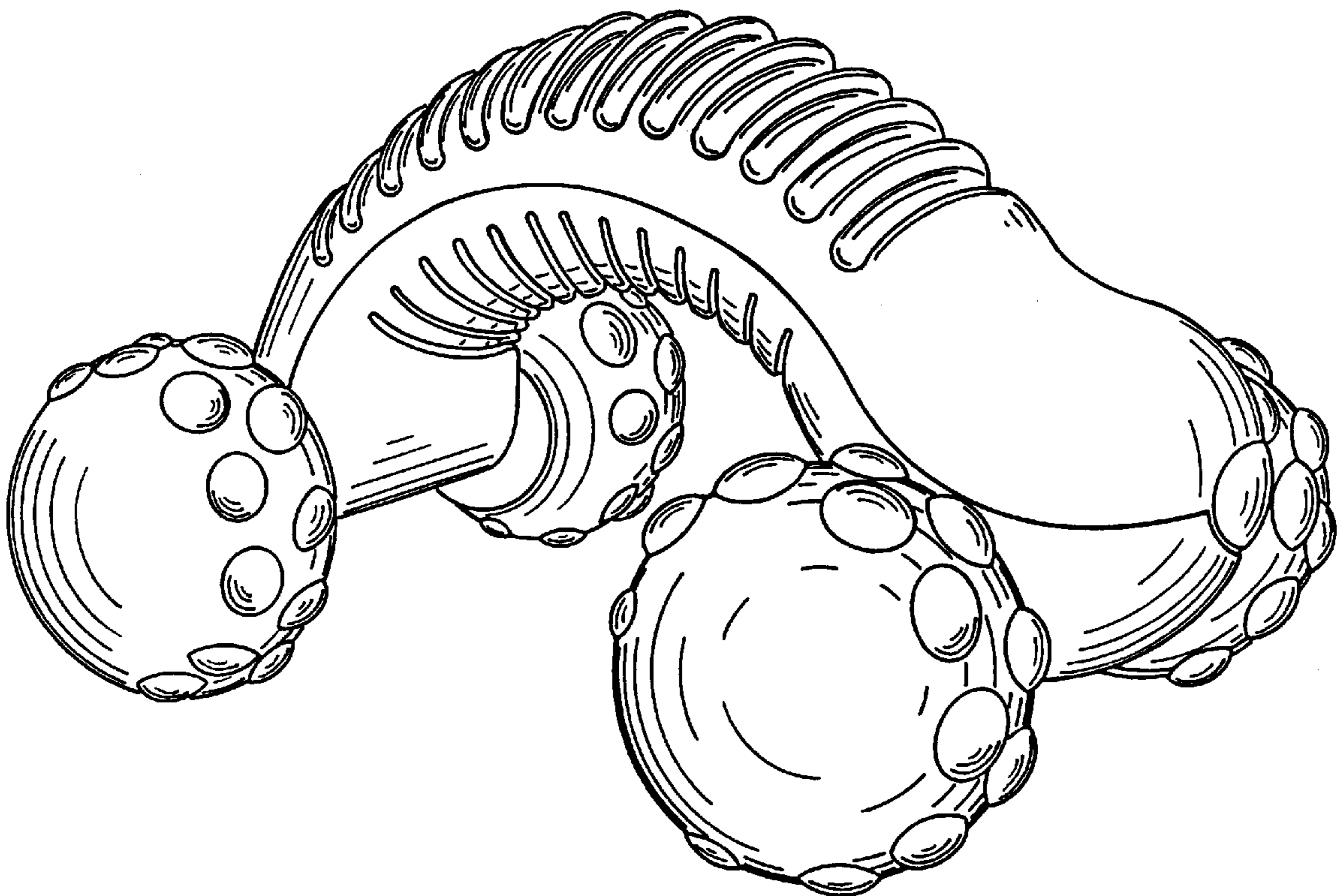

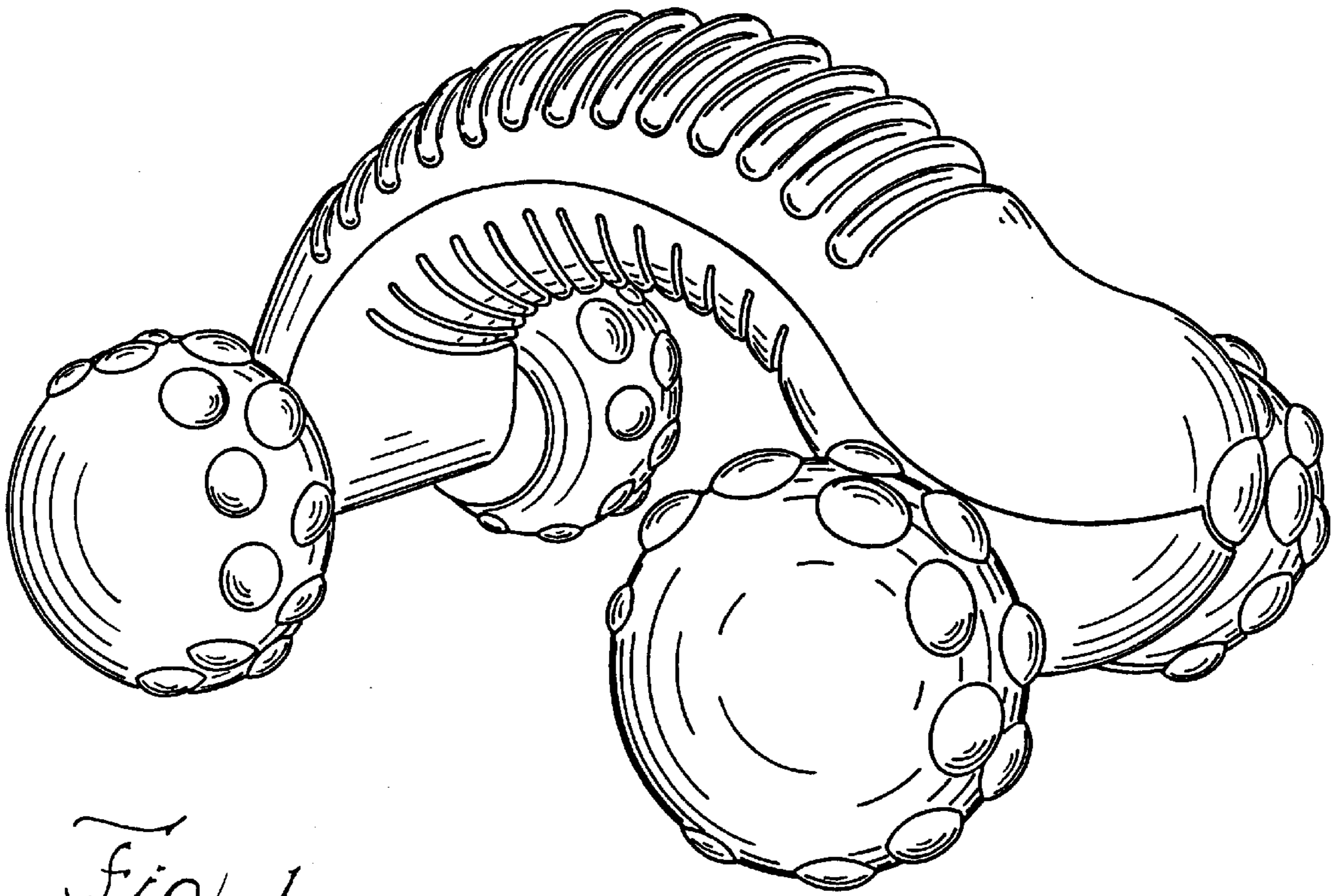

Fig. 1

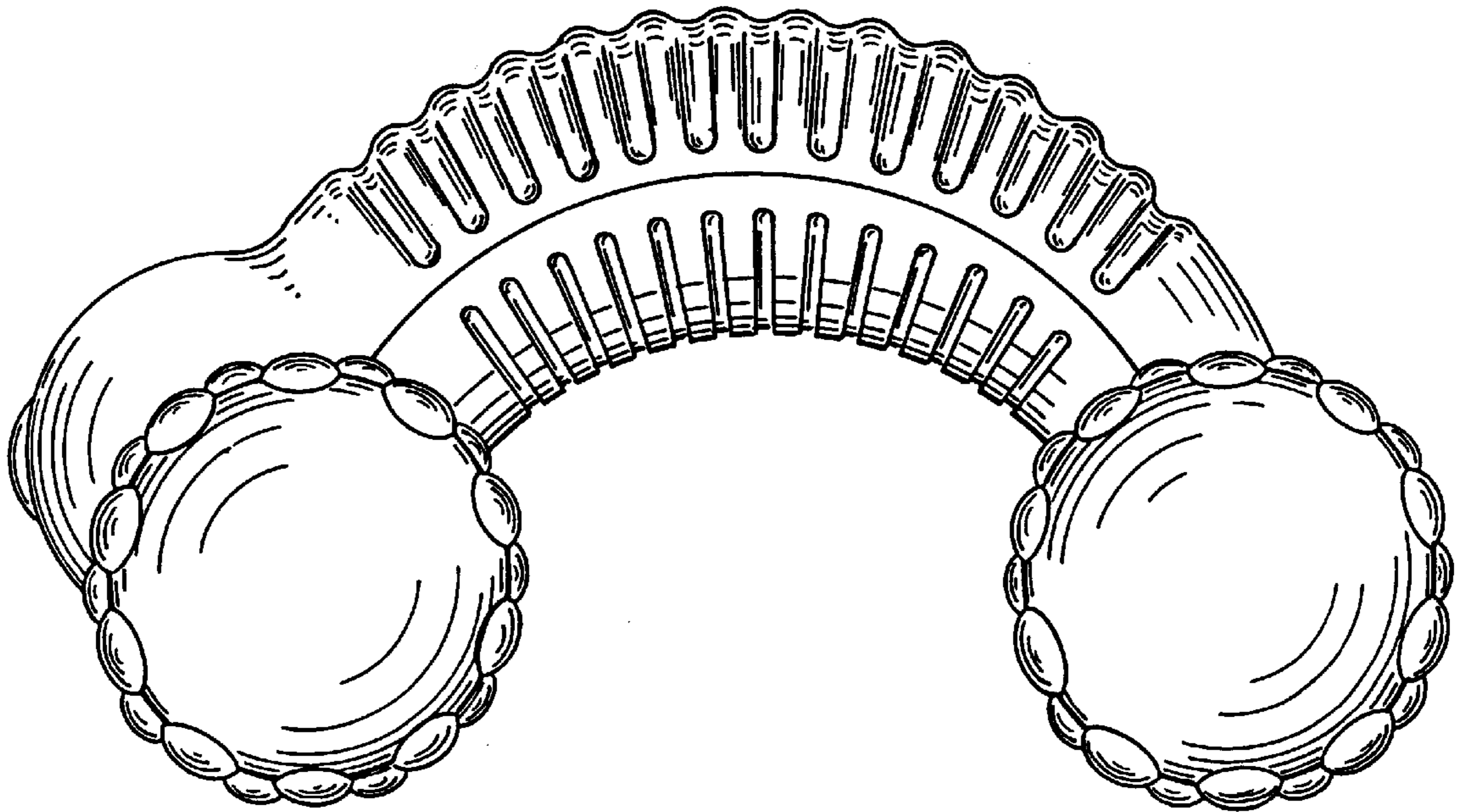

Fig. 2

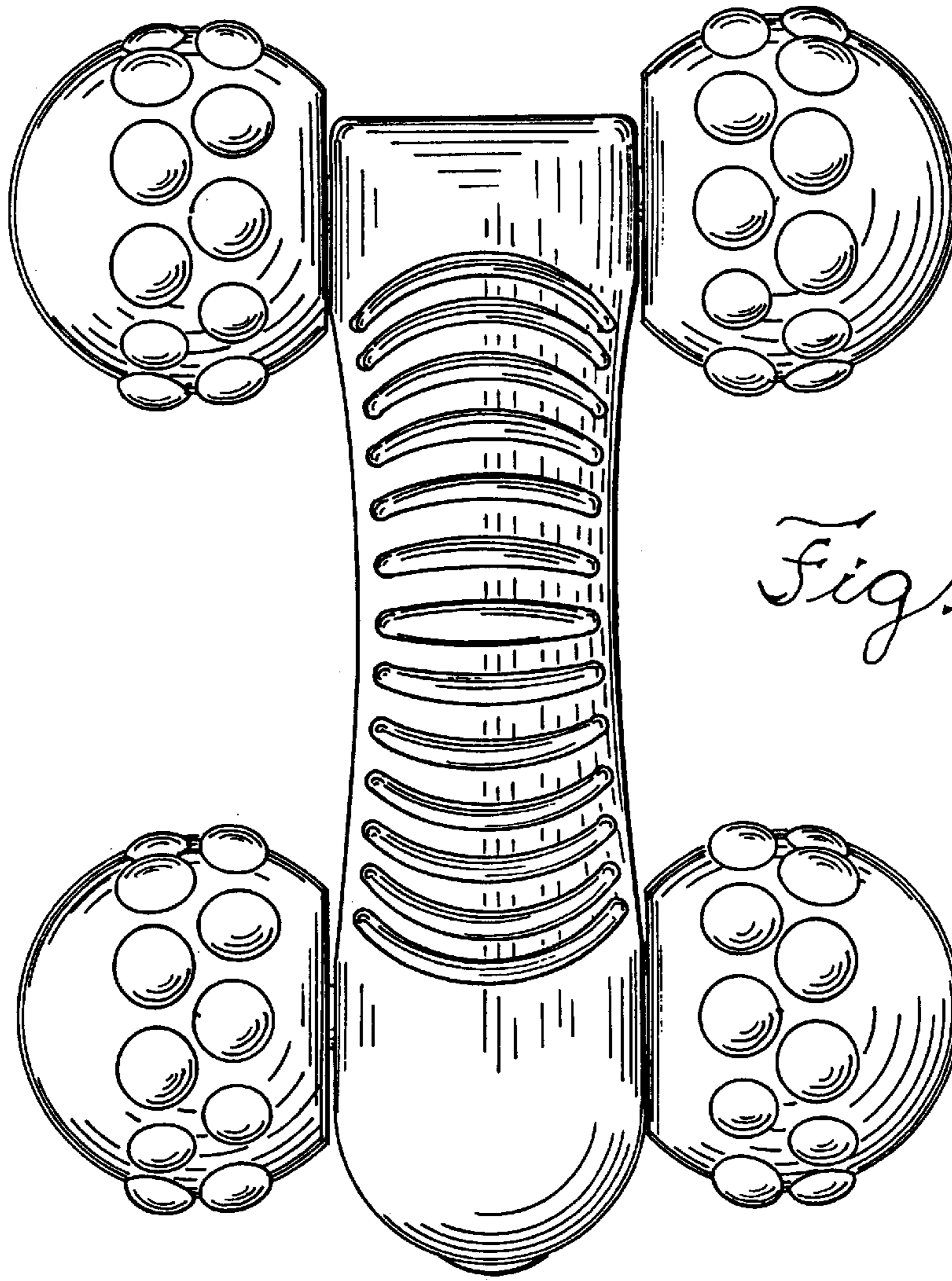
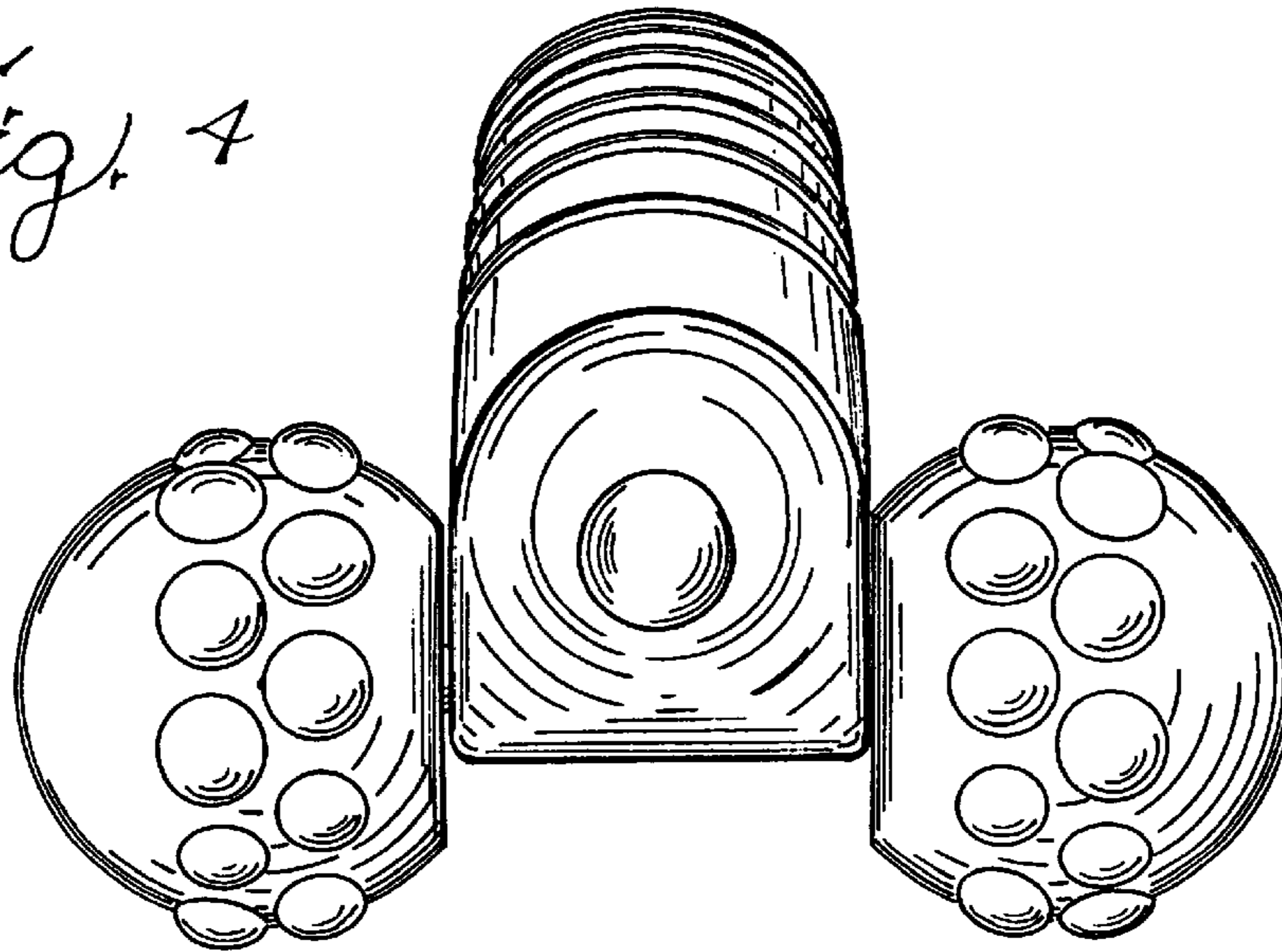

Fig. 3

Fig. 4



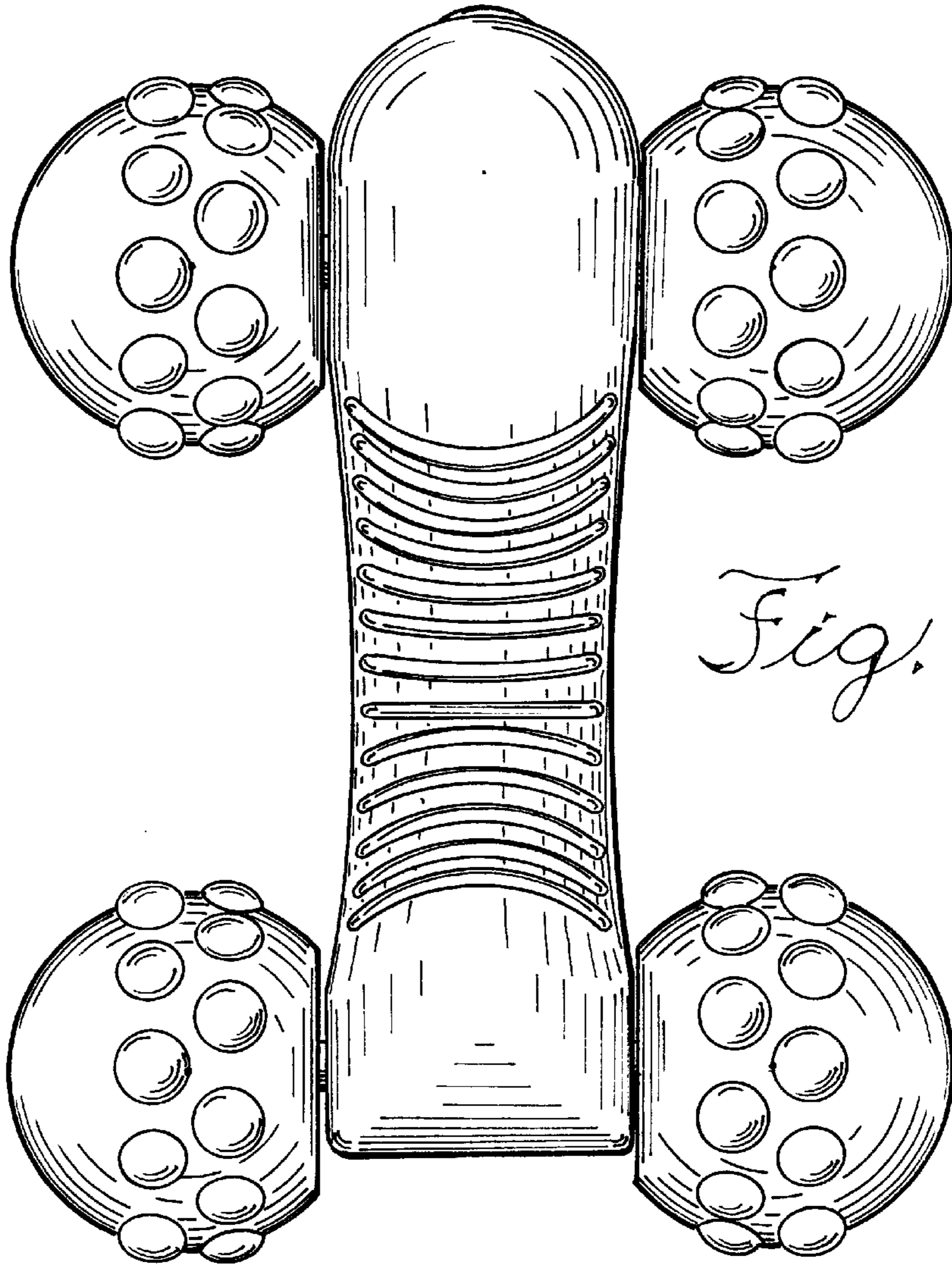
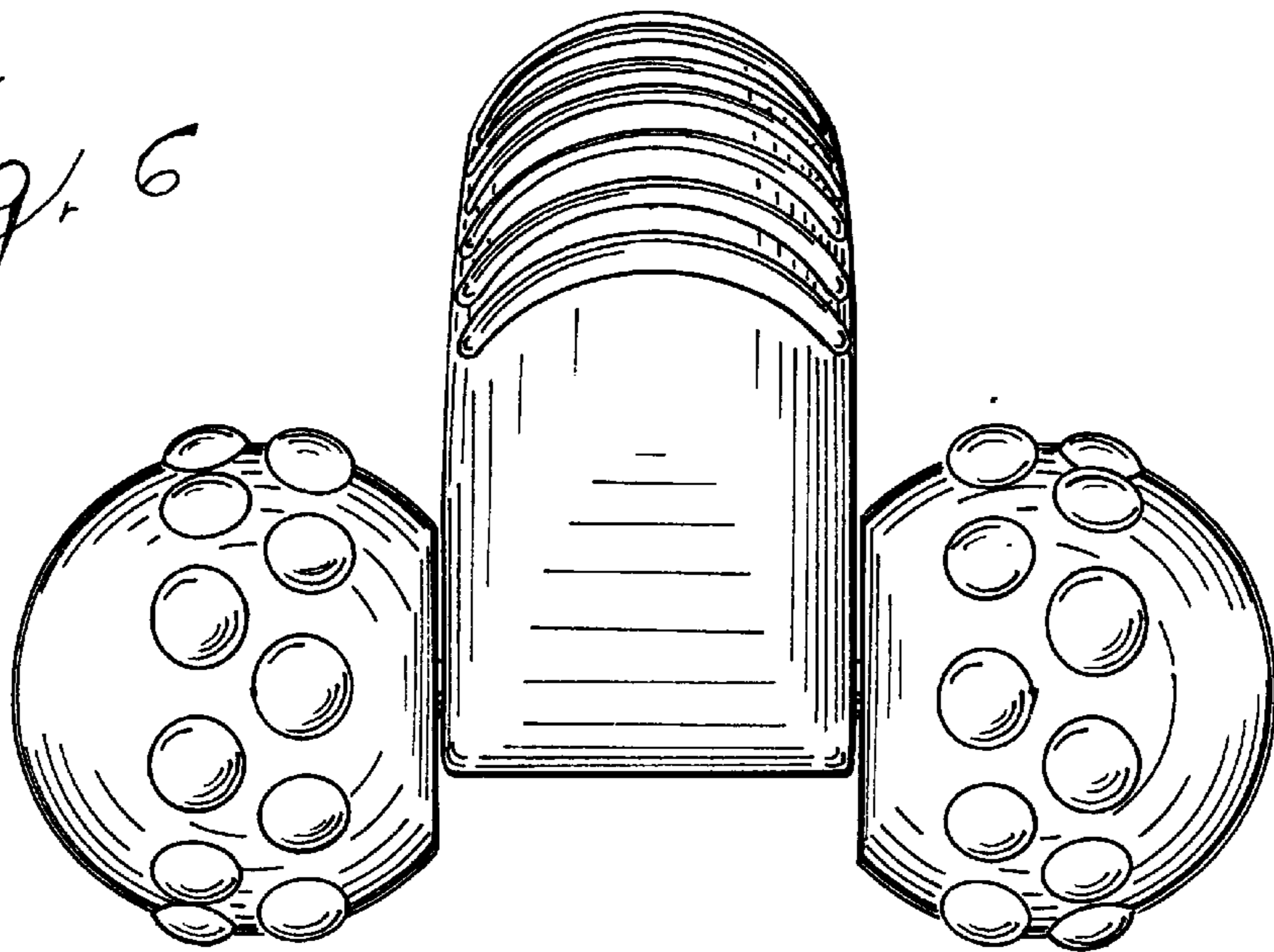

Fig. 5

Fig. 6



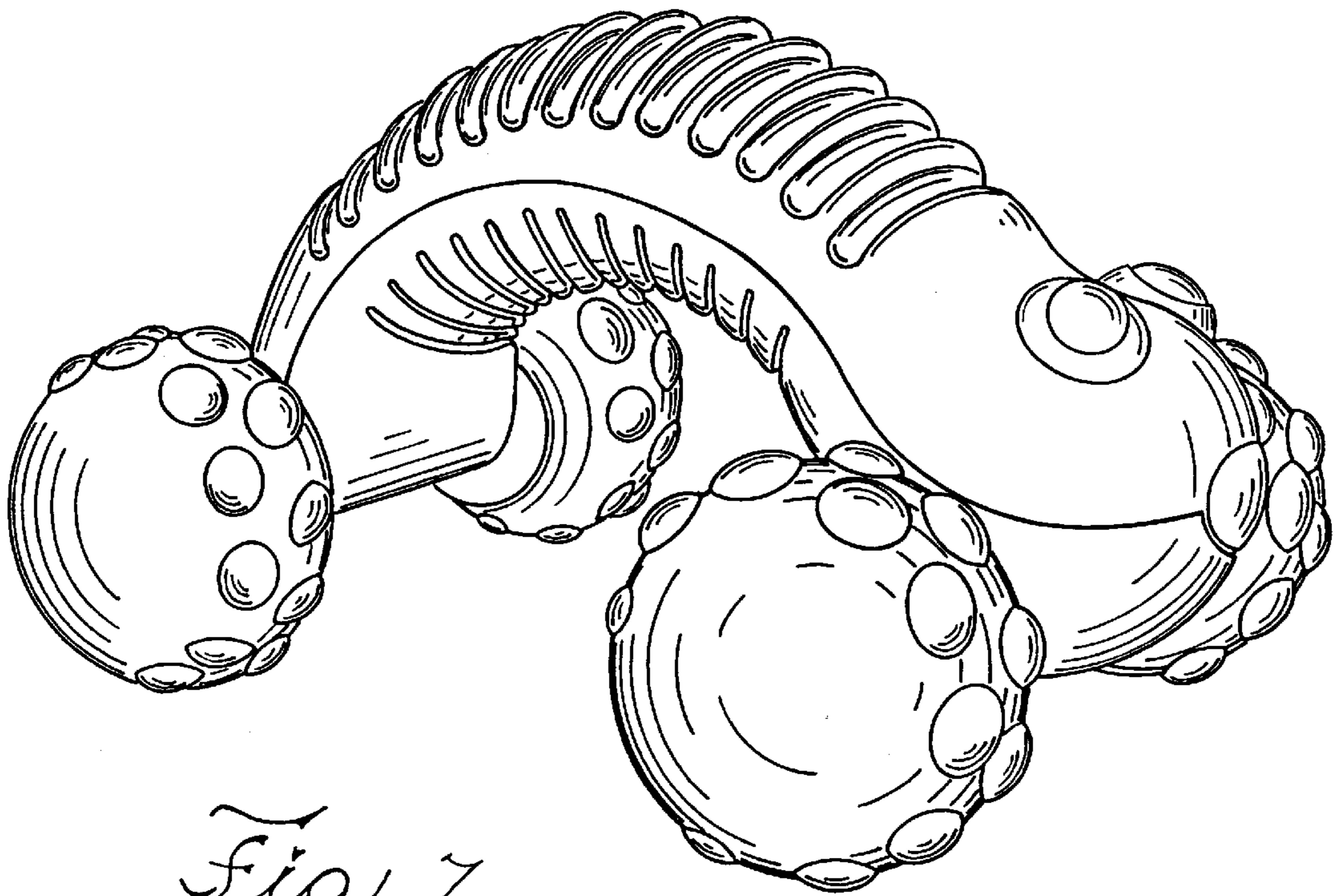

Fig. 7

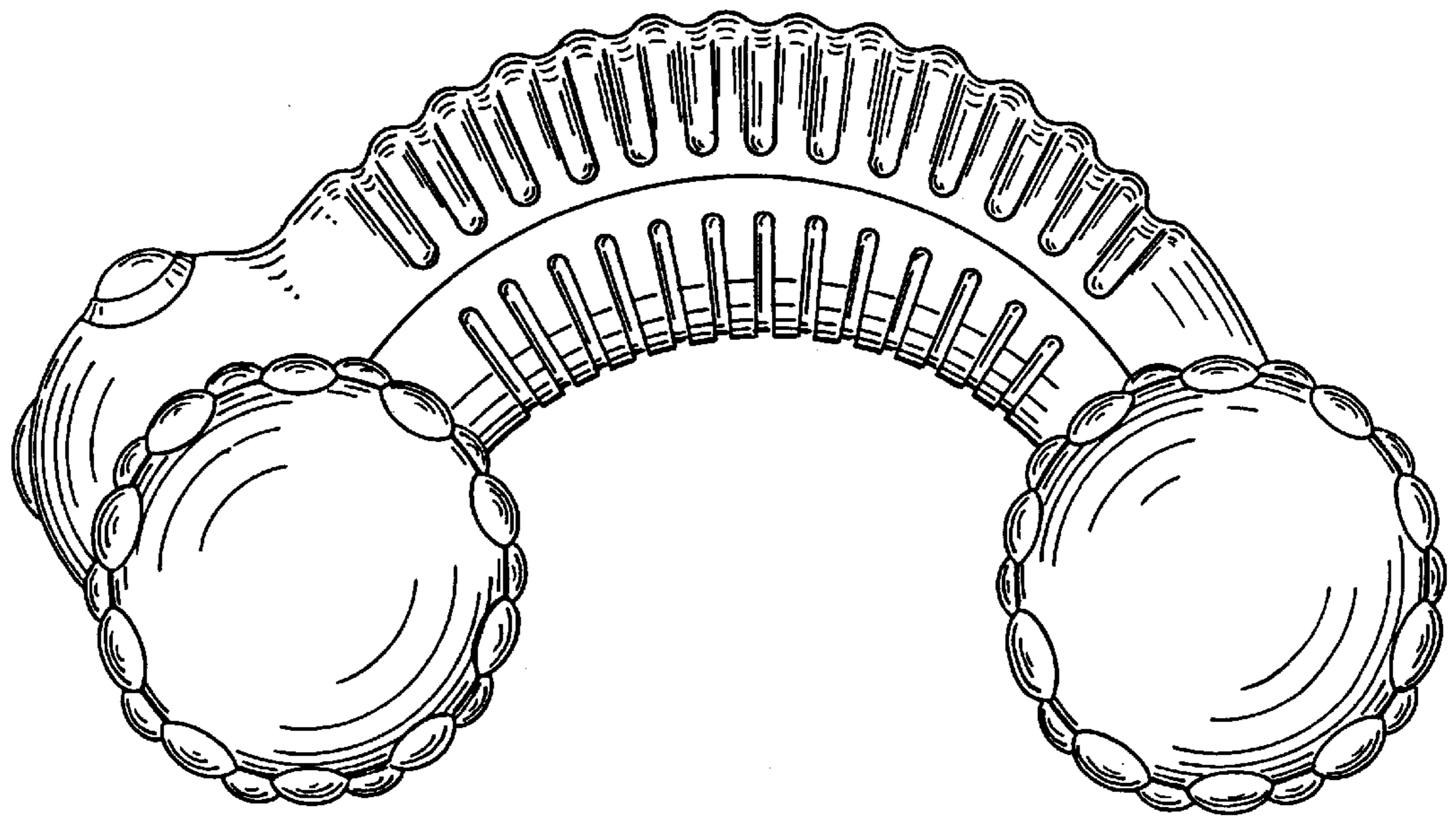

Fig. 8

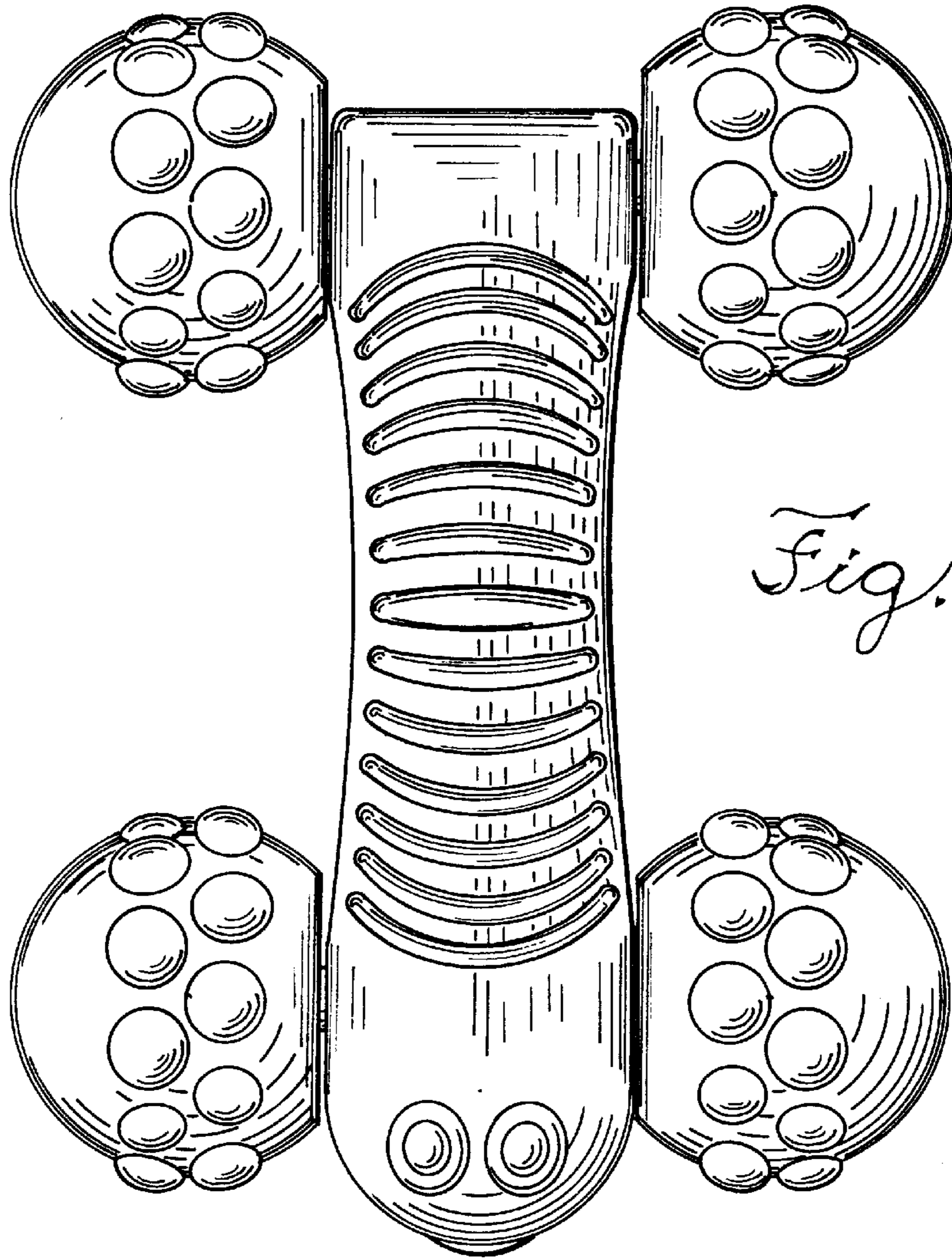

Fig. 9

Fig. 10

