



US00D422344S

United States Patent [19] Lord

[11] **Patent Number: Des. 422,344**

[45] **Date of Patent: ** *Apr. 4, 2000**

[54] **FAUCET PULL-OUT SPOUT BASE**

D. 368,764 4/1996 Hill et al. .
D. 388,156 12/1997 Hill et al. .

[75] Inventor: **Judd A. Lord**, Carmel, Ind.

OTHER PUBLICATIONS

[73] Assignee: **Masco Corporation of Indiana**, Indianapolis, Ind.

Delta Full Line Catalog, pp. 4, 5, 1994.
Delta Catalog, "The Way Water is Brought to Life", 2 pages, 1991.

[*] Notice: This patent is subject to a terminal disclaimer.

Primary Examiner—Eric Watterson
Attorney, Agent, or Firm—Myron B. Kapustij; Lloyd D. Doigan

[**] Term: **14 Years**

[21] Appl. No.: **29/092,682**

[57] CLAIM

[22] Filed: **Aug. 25, 1998**

The ornamental design for a faucet pull-out spout base, as shown and described.

[51] **LOC (6) Cl. 23-01**

DESCRIPTION

[52] **U.S. Cl. D23/255**

[58] **Field of Search D23/238-243, D23/250-257; 4/675-678; 137/801**

FIG. 1 is a top, front perspective view of the faucet pull-out spout base showing my new design;
FIG. 2 is a top, rear perspective view thereof;
FIG. 3 is a front perspective view thereof;
FIG. 4 is a rear perspective view thereof;
FIG. 5 is a top plan view thereof;
FIG. 6 is a right side elevational view thereof, the left side being a mirror image;
FIG. 7 is a rear elevational view thereof;
FIG. 8 is a front elevational view thereof; and,
FIG. 9 is a bottom plan view thereof.

[56] References Cited

U.S. PATENT DOCUMENTS

- D. 213,874 4/1969 Landell .
- D. 219,779 1/1971 Tiller .
- D. 290,492 6/1987 Hill et al. .
- D. 290,992 7/1987 Hill et al. .
- D. 291,117 7/1987 Ryan .
- D. 293,601 1/1988 Hill et al. .
- D. 323,877 2/1992 Haug et al. .
- D. 331,796 12/1992 Spangler .
- D. 352,766 11/1994 Hill et al. .
- D. 360,931 8/1995 Mark et al. .
- D. 364,211 11/1995 Hill et al. .
- D. 367,697 3/1996 Haug et al. .

The broken line showing of the pull-out spout, escutcheon, handle and hub in FIGS. 1 and 3, and of the hub in FIGS. 3-9, are for purposes of illustration only and form no part of the claimed design.

1 Claim, 2 Drawing Sheets

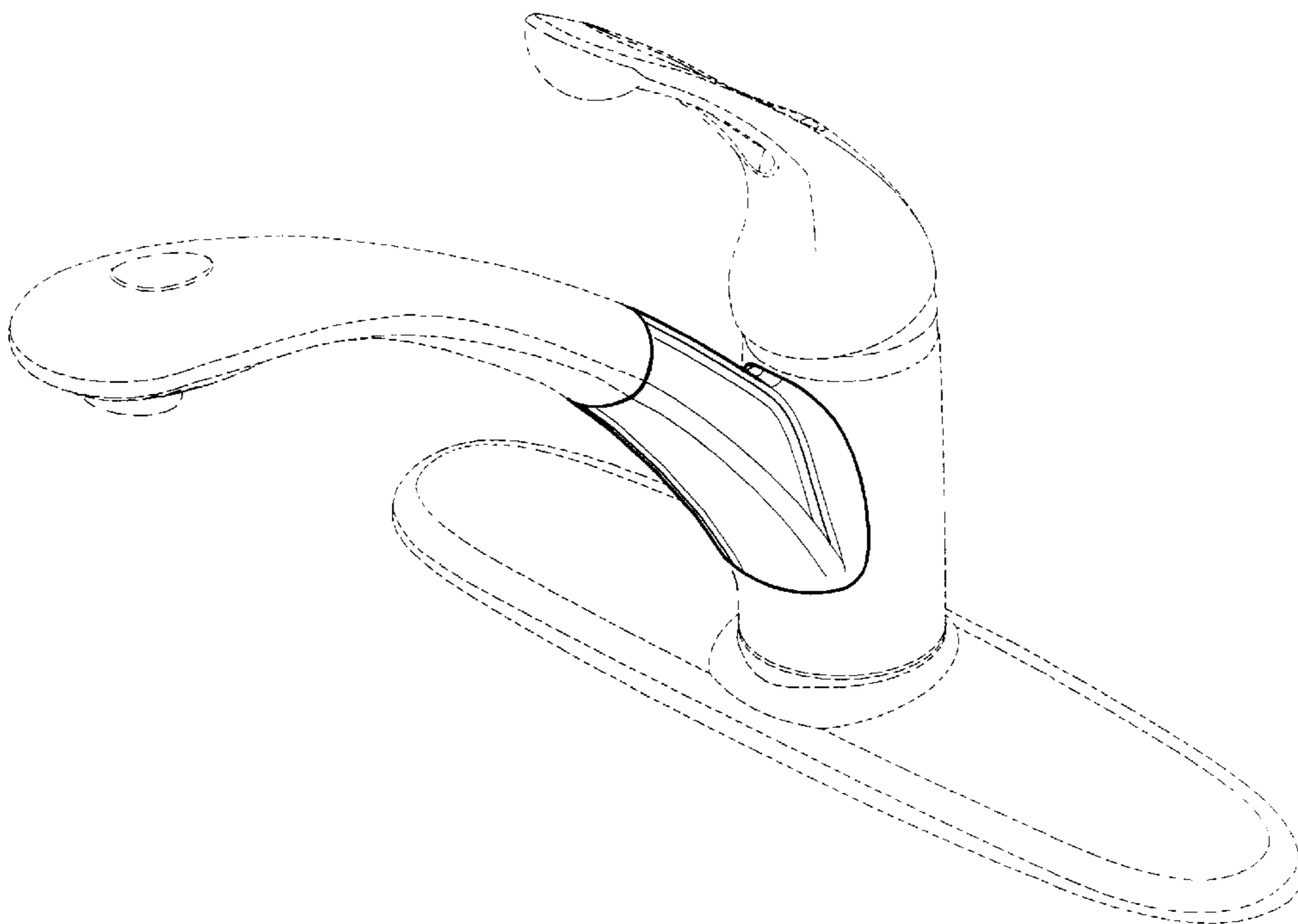

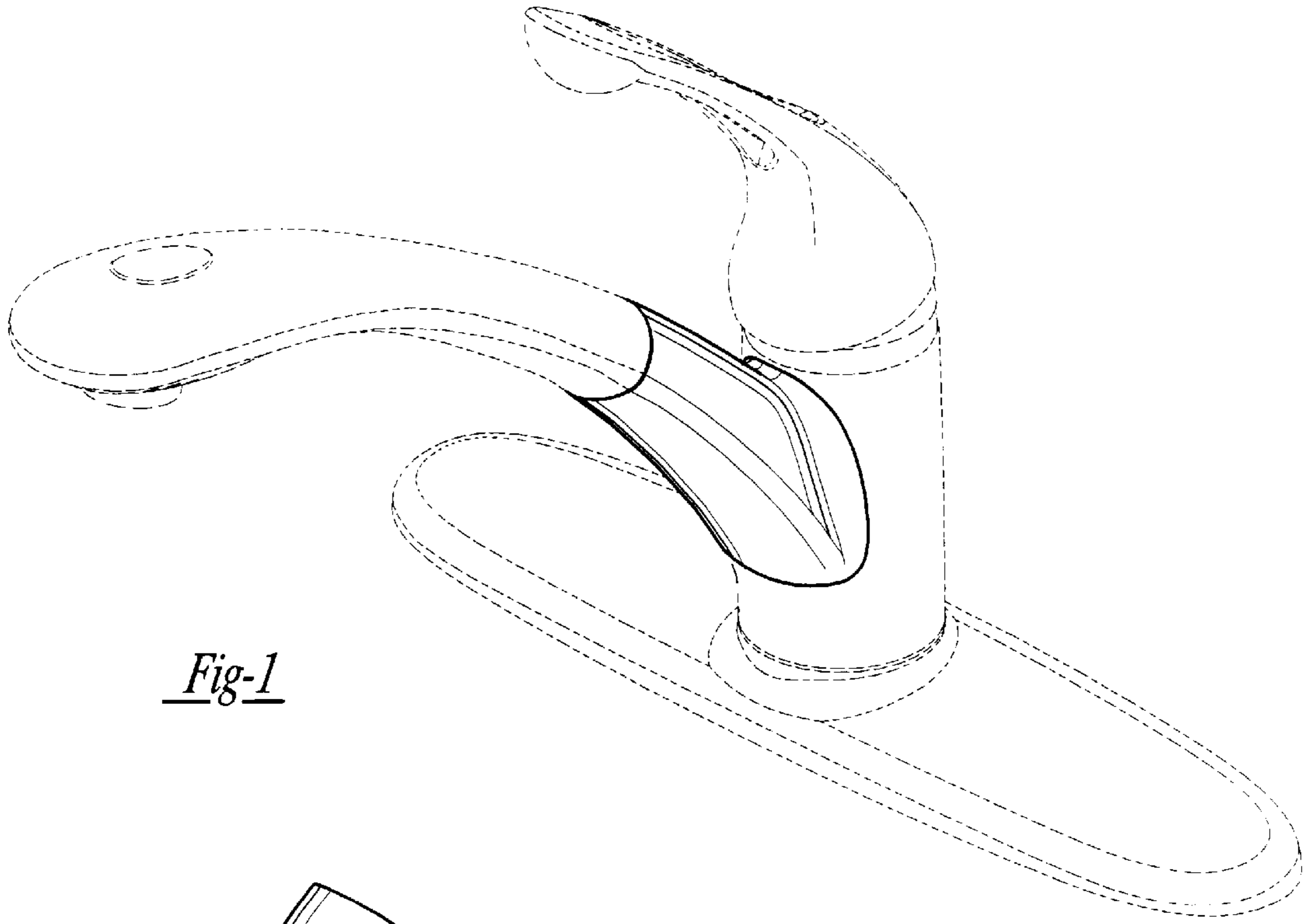

Fig-1

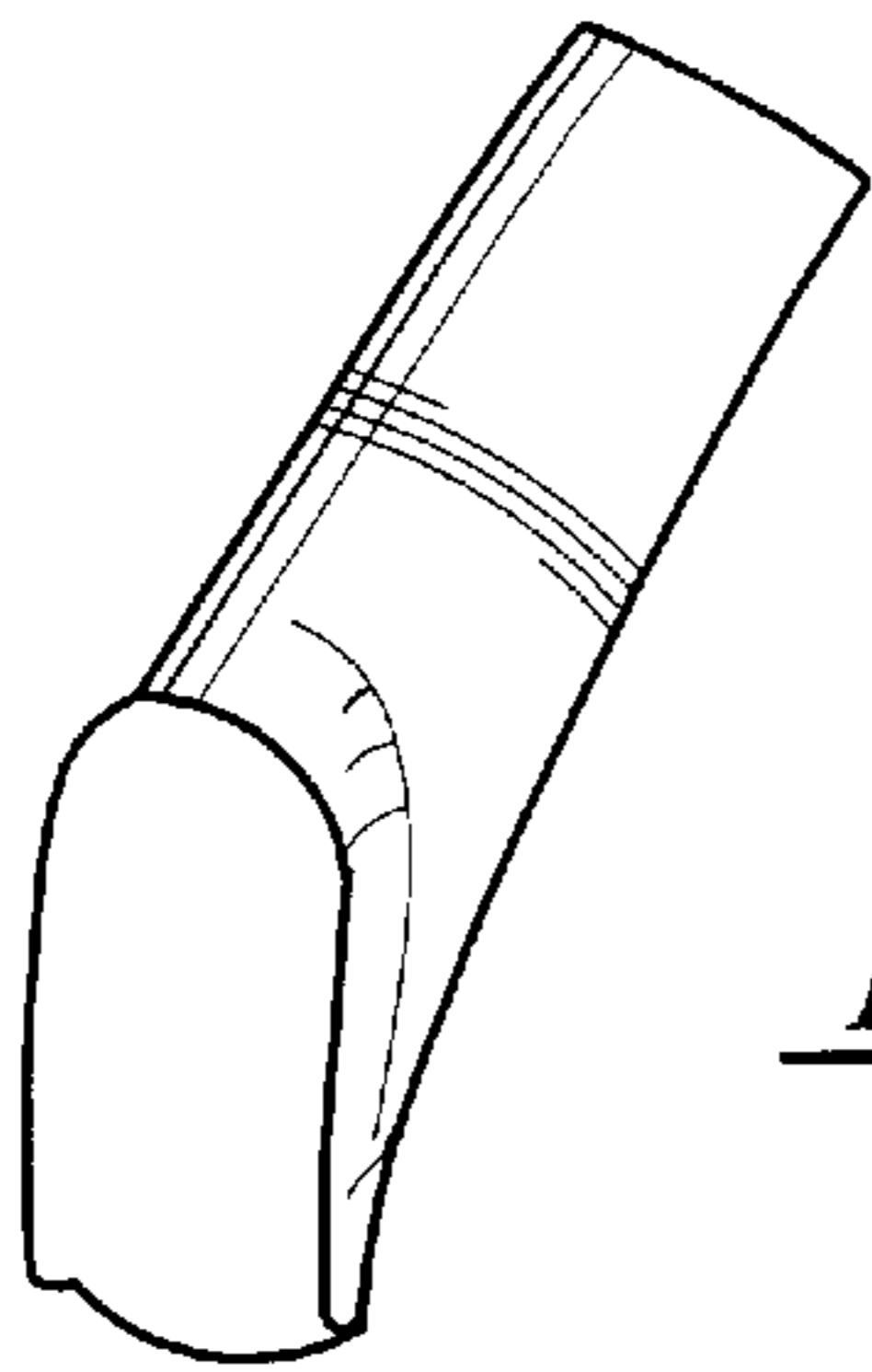

Fig-2

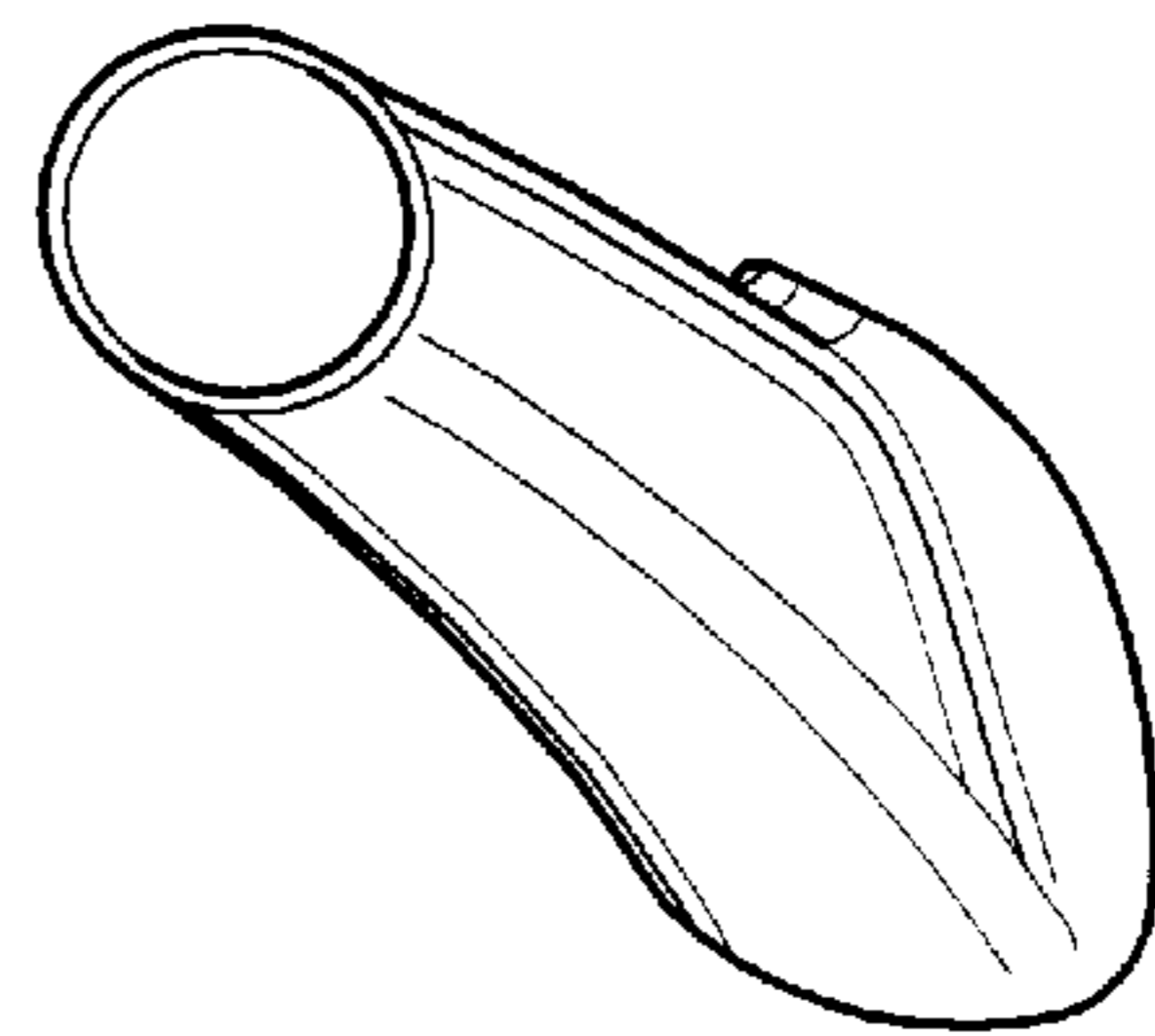

Fig-3

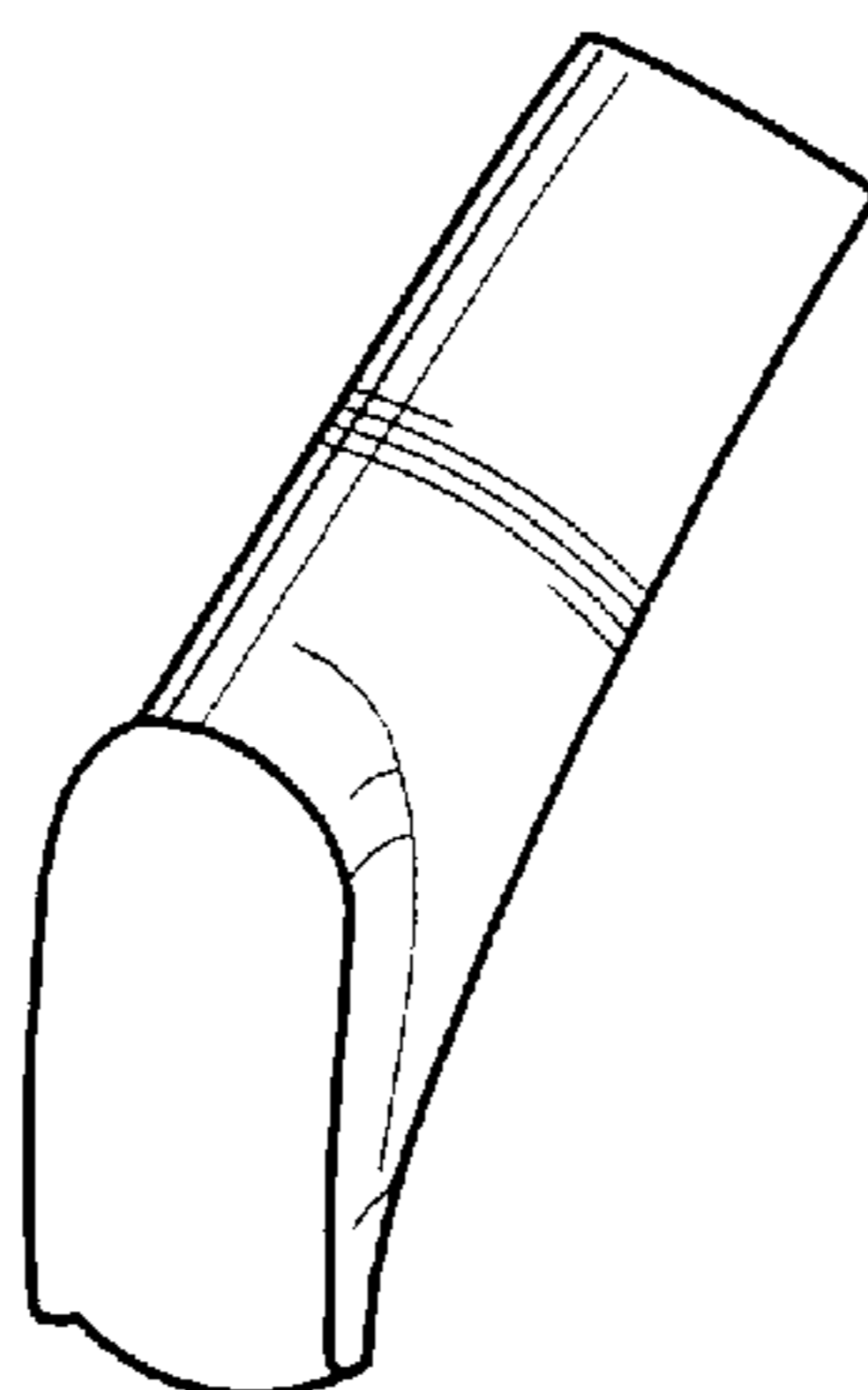

Fig-4

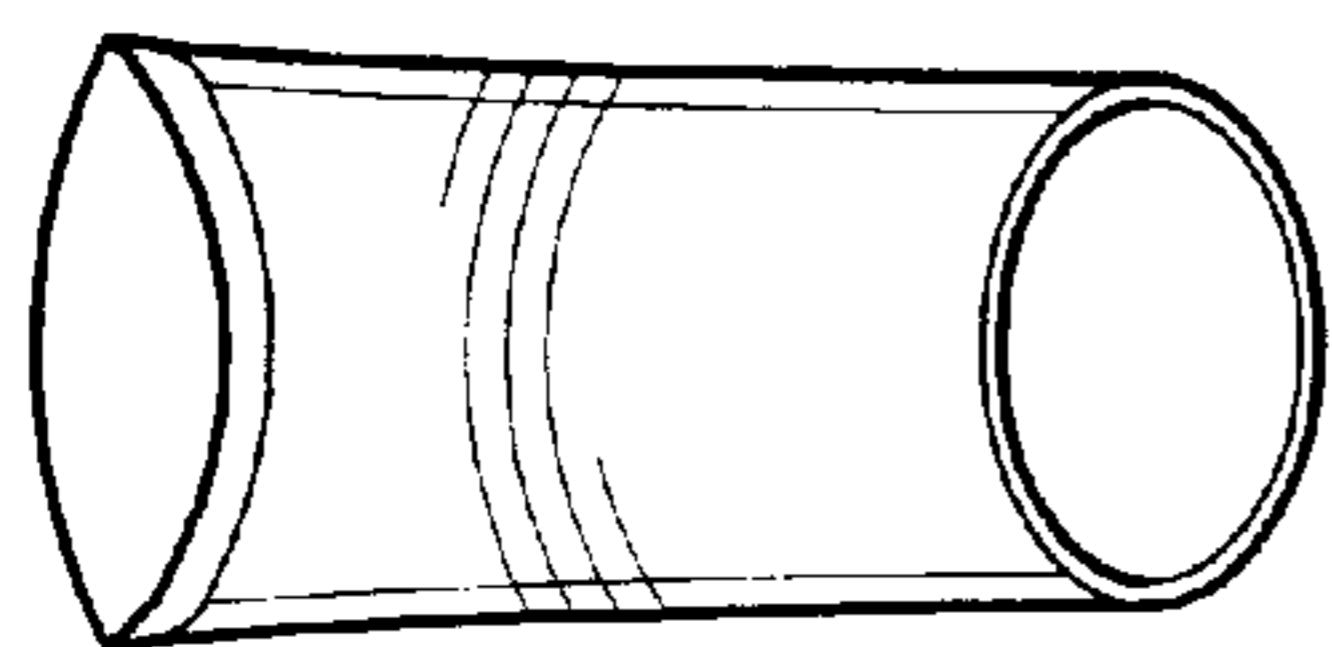

Fig-5

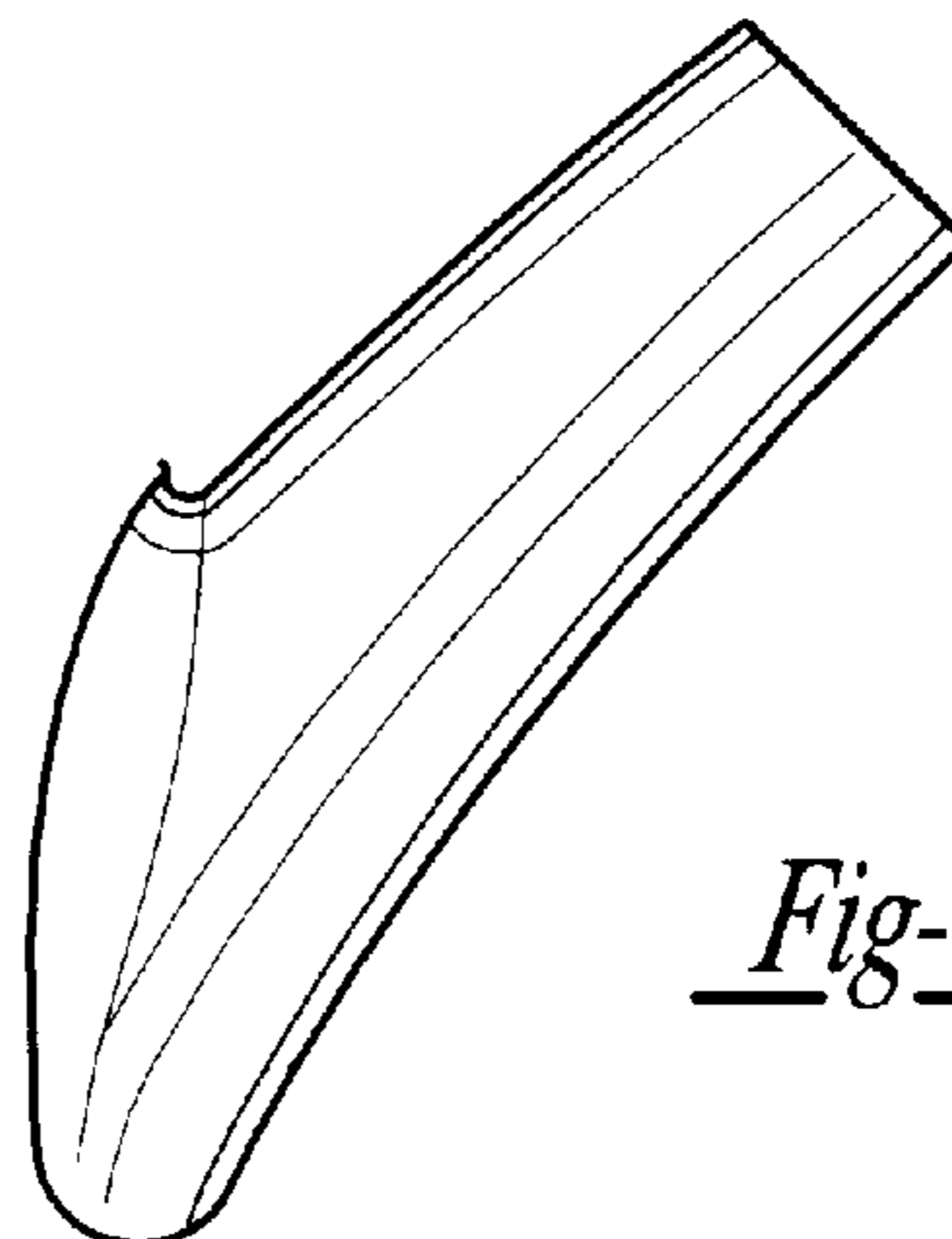

Fig-6

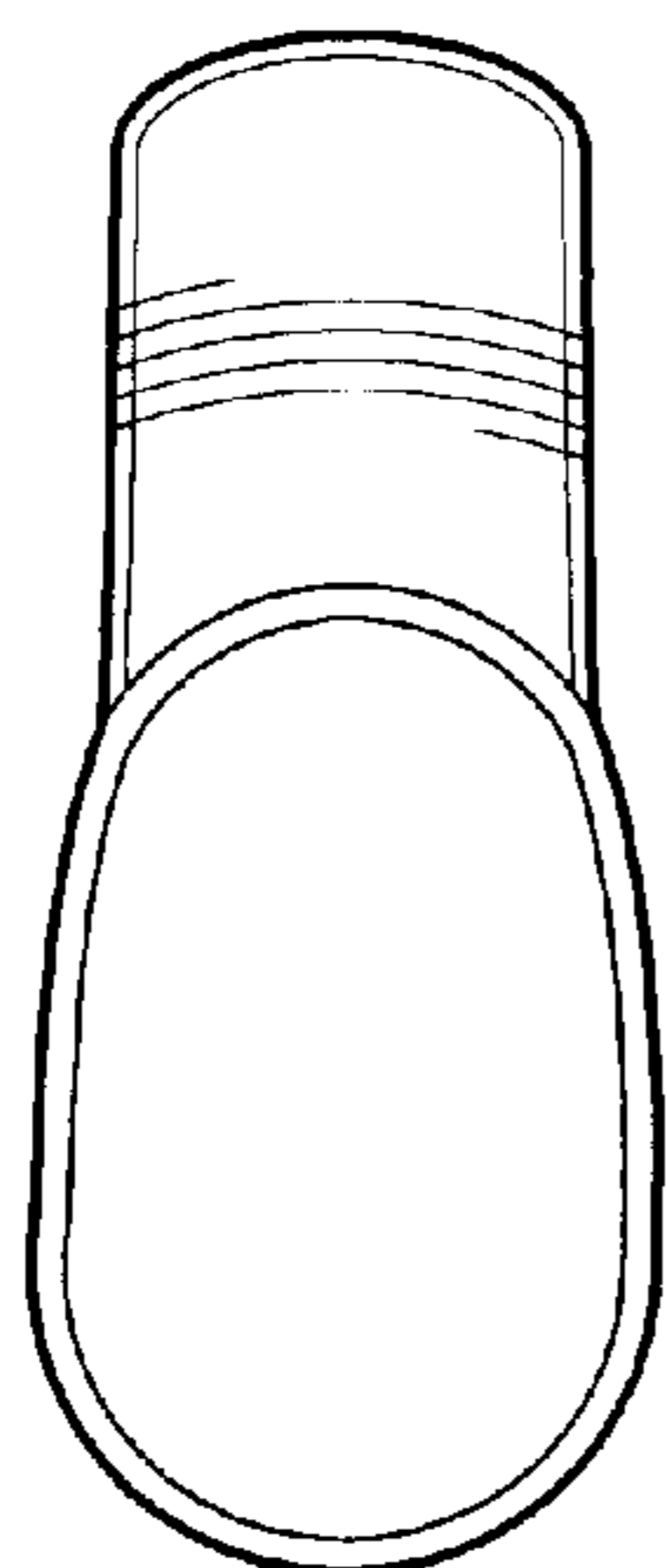

Fig-7

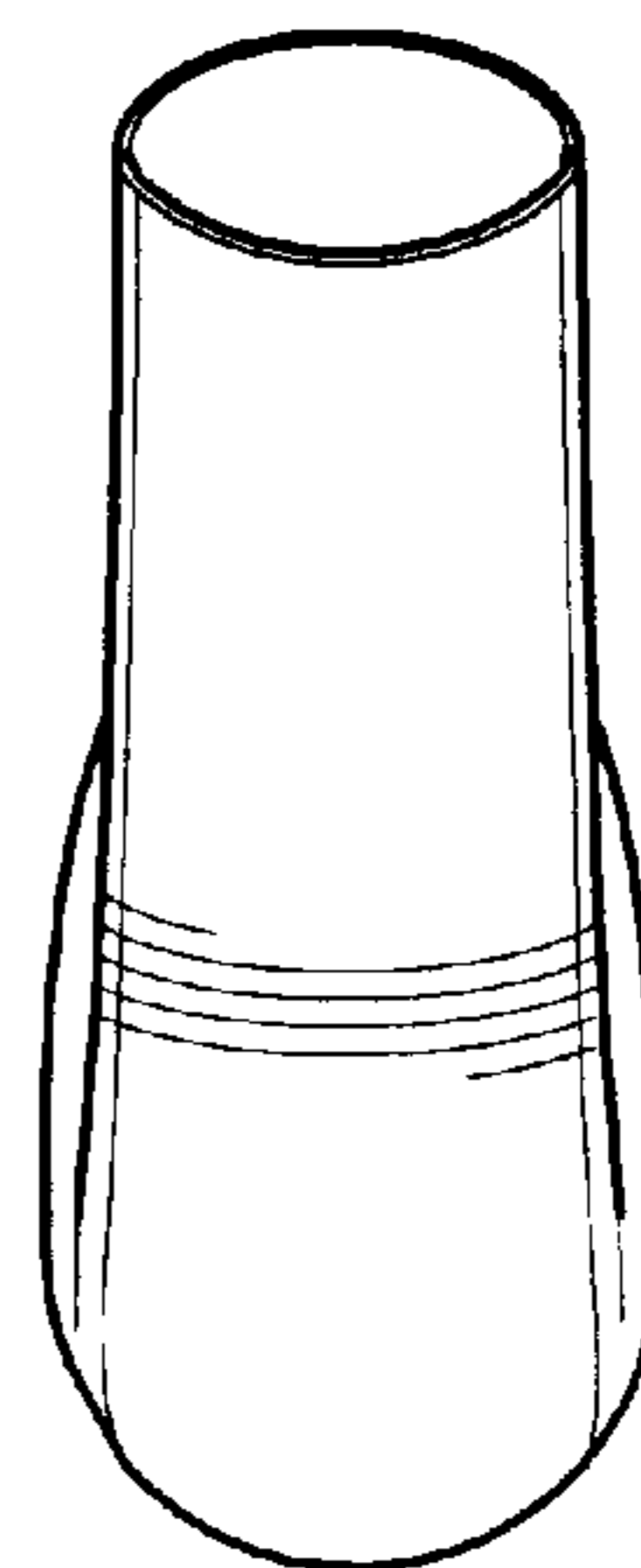

Fig-8

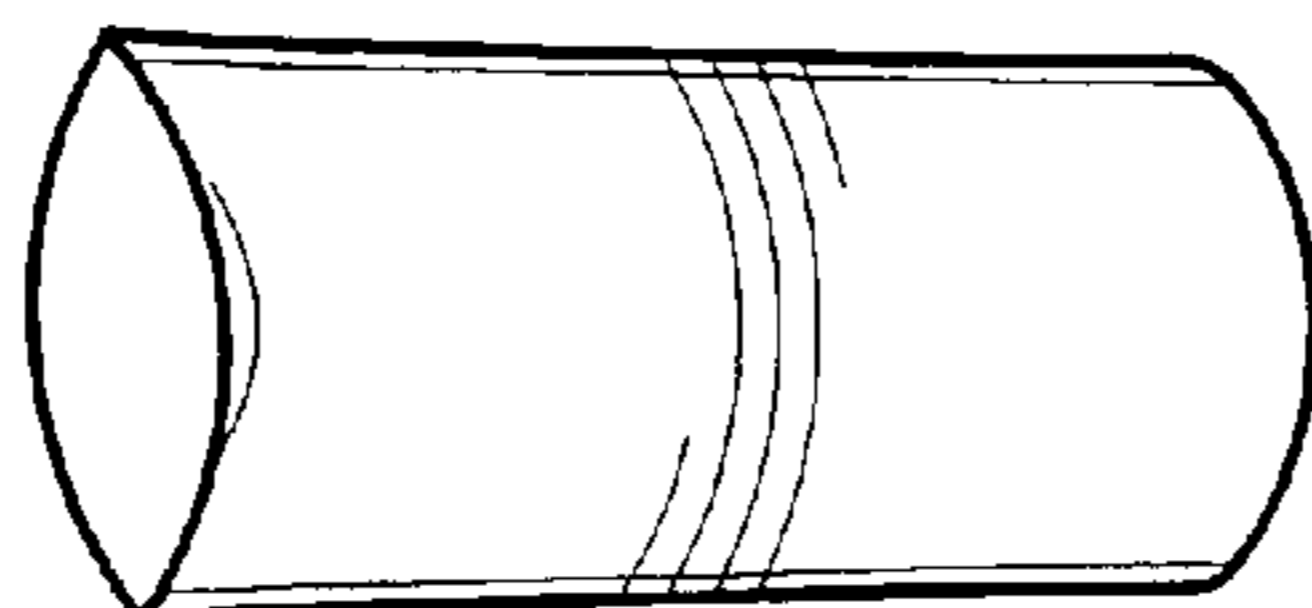

Fig-9