



US00D422302S

United States Patent [19]

Ohashi et al.

[11] Patent Number: **Des. 422,302**

[45] Date of Patent: **** Apr. 4, 2000**

[54] **TONER CARTRIDGE FOR PHOTOCOPIER**

[75] Inventors: **Hiroaki Ohashi**, Komae; **Fumio Tazawa**, Numazu, both of Japan

[73] Assignee: **Canon Kabushiki Kaisha**, Tokyo, Japan

[**] Term: **14 Years**

[21] Appl. No.: **29/102,514**

[22] Filed: **Mar. 25, 1999**

[30] Foreign Application Priority Data

Sep. 28, 1998 [JP] Japan 10-27650

[51] **LOC (6) Cl.** **16-03**

[52] **U.S. Cl.** **D18/43**

[58] **Field of Search** D18/36, 40, 43,
D18/56; 399/24, 25, 27, 28, 61, 99, 106,
262

[56] References Cited

U.S. PATENT DOCUMENTS

D. 298,258 10/1988 Masaki D18/43

D. 312,271 11/1990 Komada et al. D18/43
D. 333,833 3/1993 Yamamoto et al. D18/43
D. 346,179 4/1994 Haida D18/56
D. 353,615 12/1994 Agata et al. D18/43

Primary Examiner—Caron D. Veynar
Attorney, Agent, or Firm—Fitzpatrick, Cella, Harper & Scinto

[57] CLAIM

The ornamental design for a toner cartridge for photocopier, as shown and described.

DESCRIPTION

FIG. 1 is a front view of a toner cartridge for photocopier showing our new design;
FIG. 2 is a rear view thereof;
FIG. 3 is a top plan view thereof;
FIG. 4 is a bottom plan view thereof;
FIG. 5 is a left side view thereof;
FIG. 6 is a right side view thereof; and,
FIG. 7 is a perspective view thereof.

1 Claim, 4 Drawing Sheets

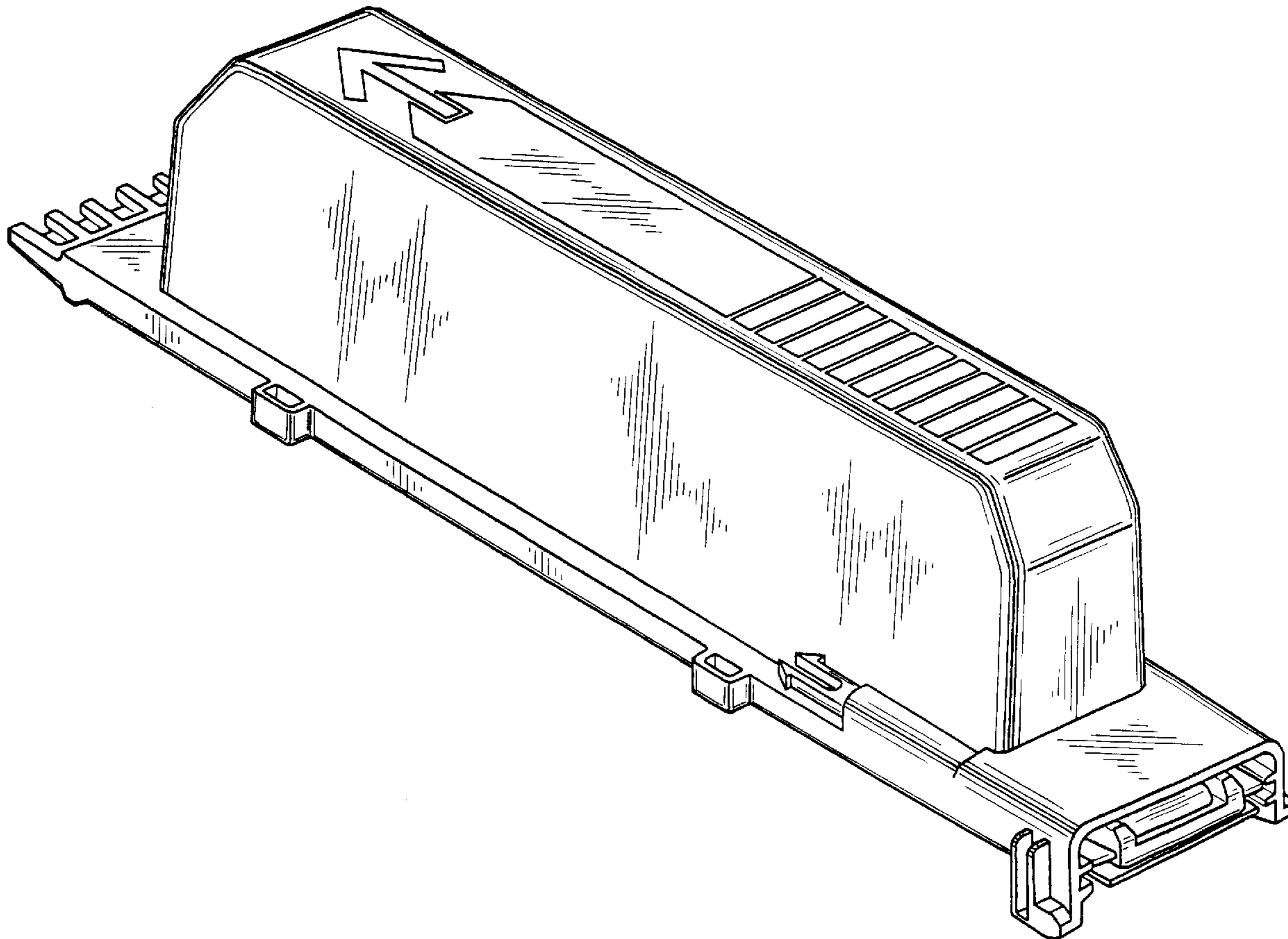

FIG. 1

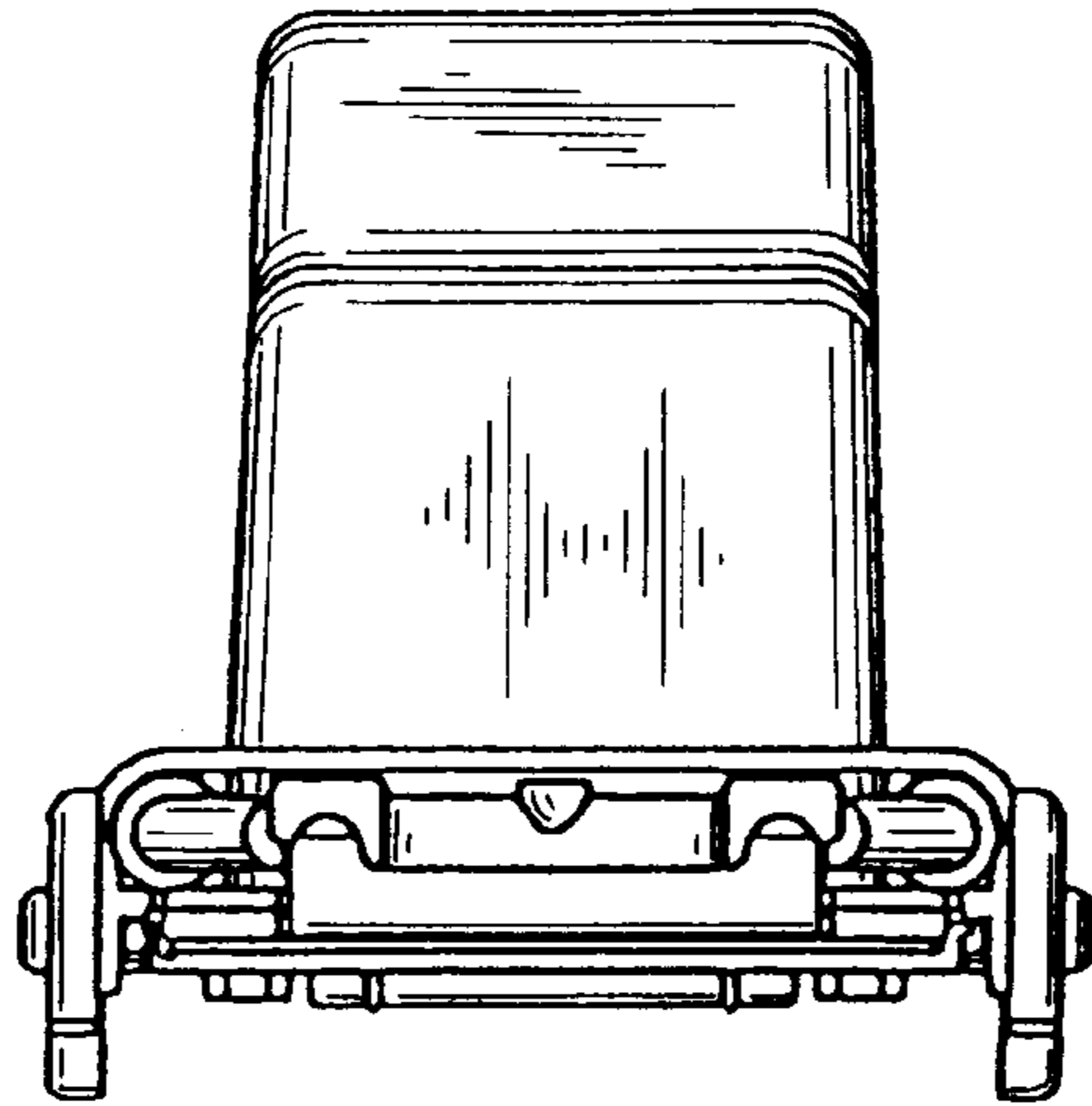

FIG. 2

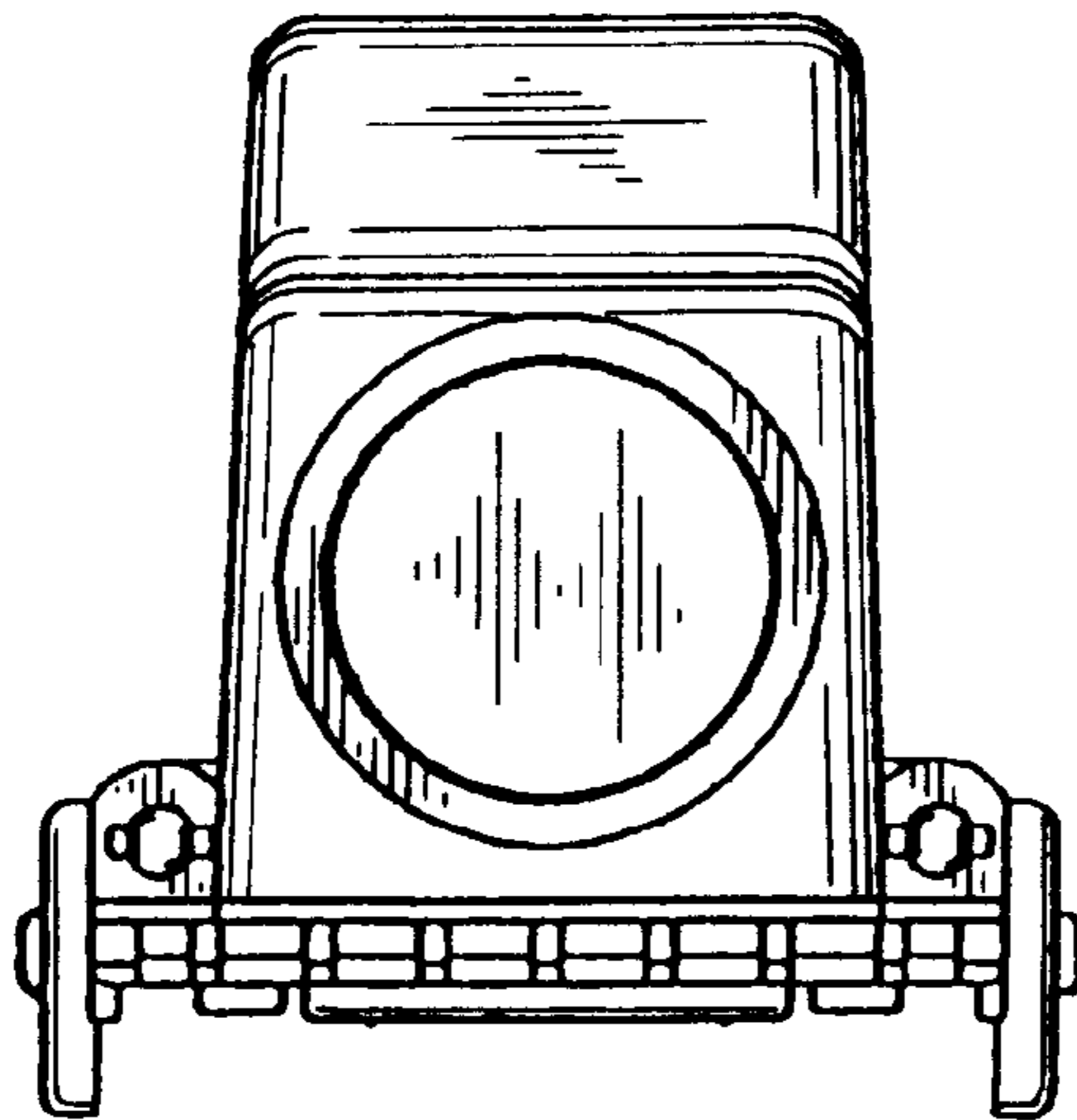

FIG. 3

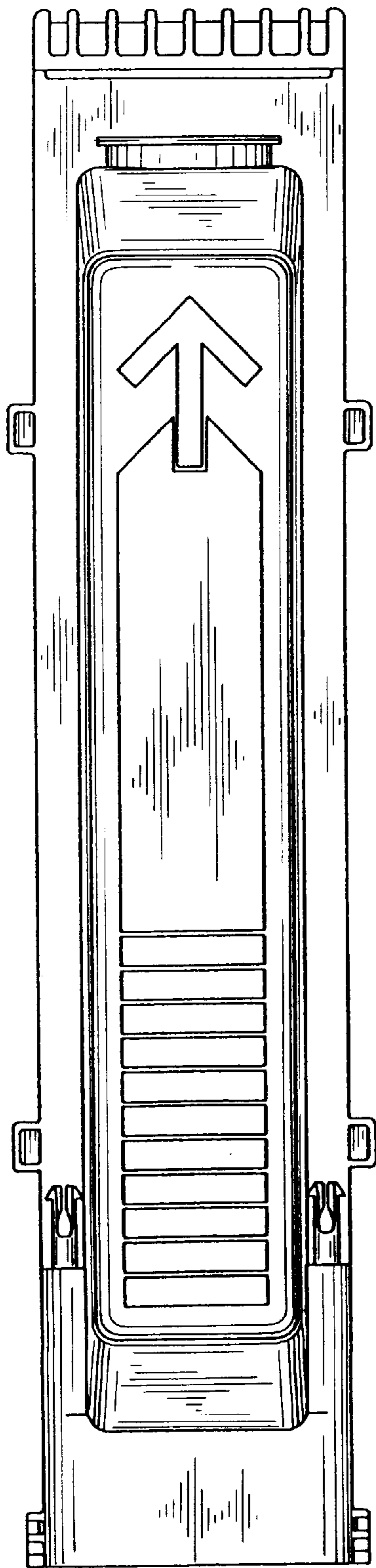

FIG. 4

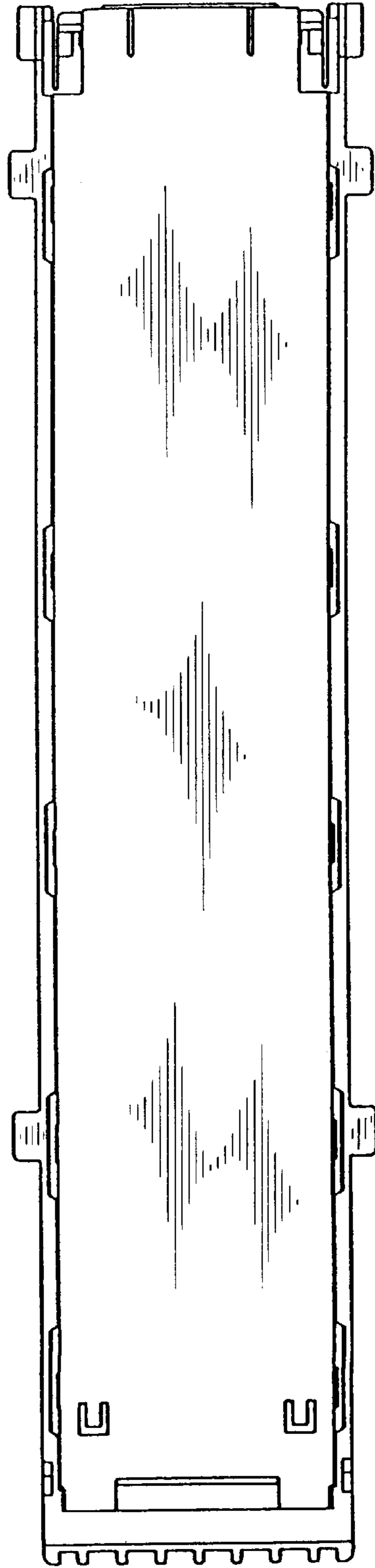

FIG. 5

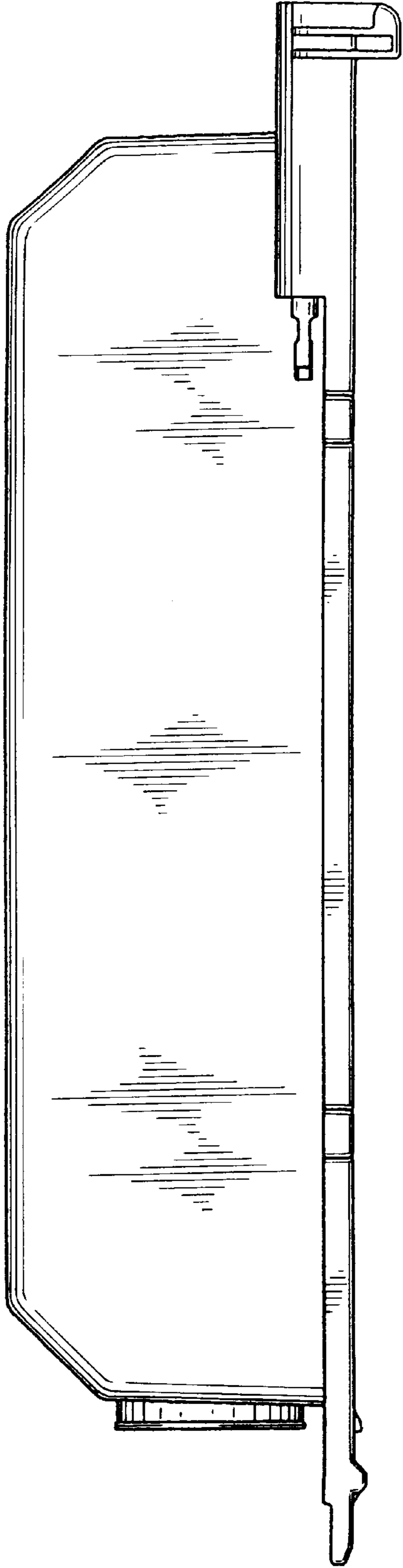

FIG. 6

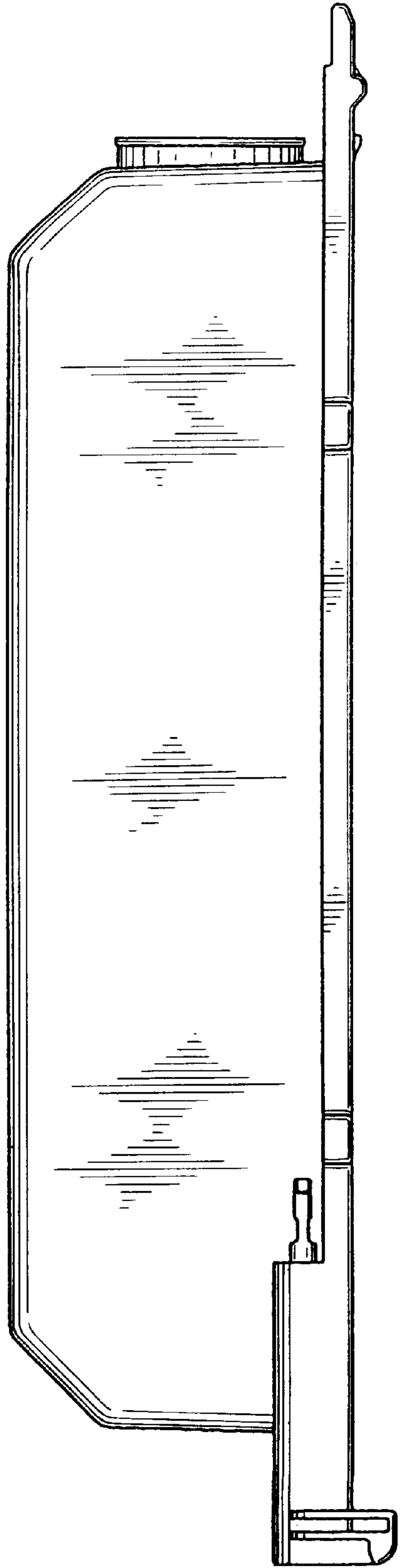

FIG. 7

