



US00D422170S

United States Patent [19]
Harris, Jr.

[11] **Patent Number: Des. 422,170**
[45] **Date of Patent: ** Apr. 4, 2000**

[54] **PAPER TOWEL DISPENSER**

Primary Examiner—Brian N. Vinson

[76] Inventor: **Bennie Harris, Jr.**, 1818 Abila St.,
Carson, Calif. 90745

[57] **CLAIM**

[**] Term: **14 Years**

The ornamental design for a paper towel dispenser, as shown.

[21] Appl. No.: **29/107,547**

DESCRIPTION

[22] Filed: **Jul. 8, 1999**

[51] **LOC (6) Cl.** **07-07**

[52] **U.S. Cl.** **D6/521; D6/522**

[58] **Field of Search** D6/518, 521, 522;
312/34.1, 34.8; 242/570, 600, 601; 206/228,
389

FIG. 1 is a front elevational view of the paper towel dispenser of the present invention;
FIG. 2 is a rear elevational view of the paper towel dispenser of FIG. 1;
FIG. 3 is a left side elevational view of the paper towel dispenser of FIG. 1;
FIG. 4 is a right side elevational view of the paper towel dispenser of FIG. 1;
FIG. 5 is a top plan view of the paper towel dispenser of FIG. 1;
FIG. 6 is a bottom plan view of the paper towel dispenser in FIG. 1; and,
FIG. 7 is a top, front, right side perspective view alternate embodiment of the paper towel dispenser of FIG. 1.

[56] **References Cited**

U.S. PATENT DOCUMENTS

D. 316,789	5/1991	McLaughlin	D6/522
D. 389,683	1/1998	Herrera	D6/522
D. 404,947	2/1999	Porcelli	D6/522
876,282	1/1908	Parmenter	D6/521 X
4,177,958	12/1979	Poole	312/34.8 X

1 Claim, 4 Drawing Sheets

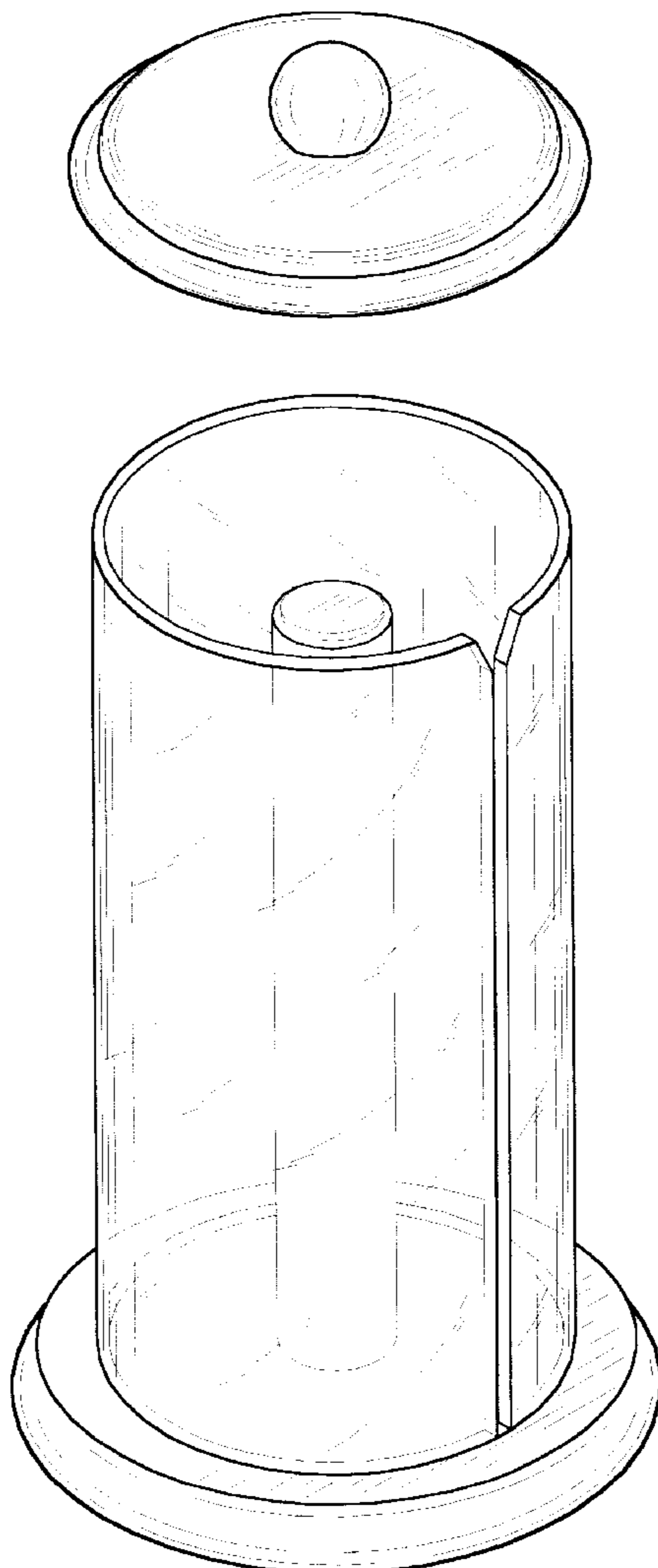

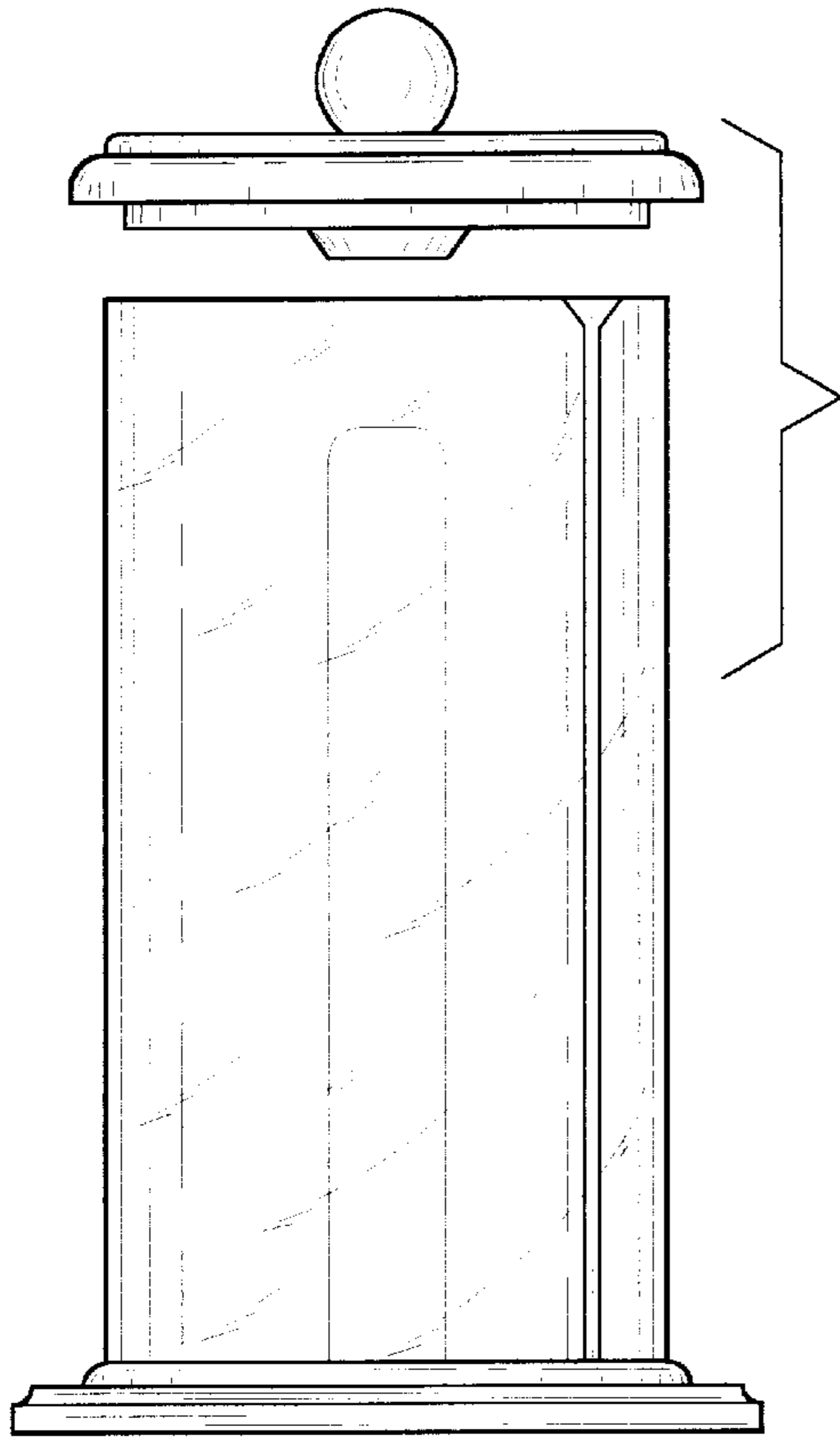

Fig. 1

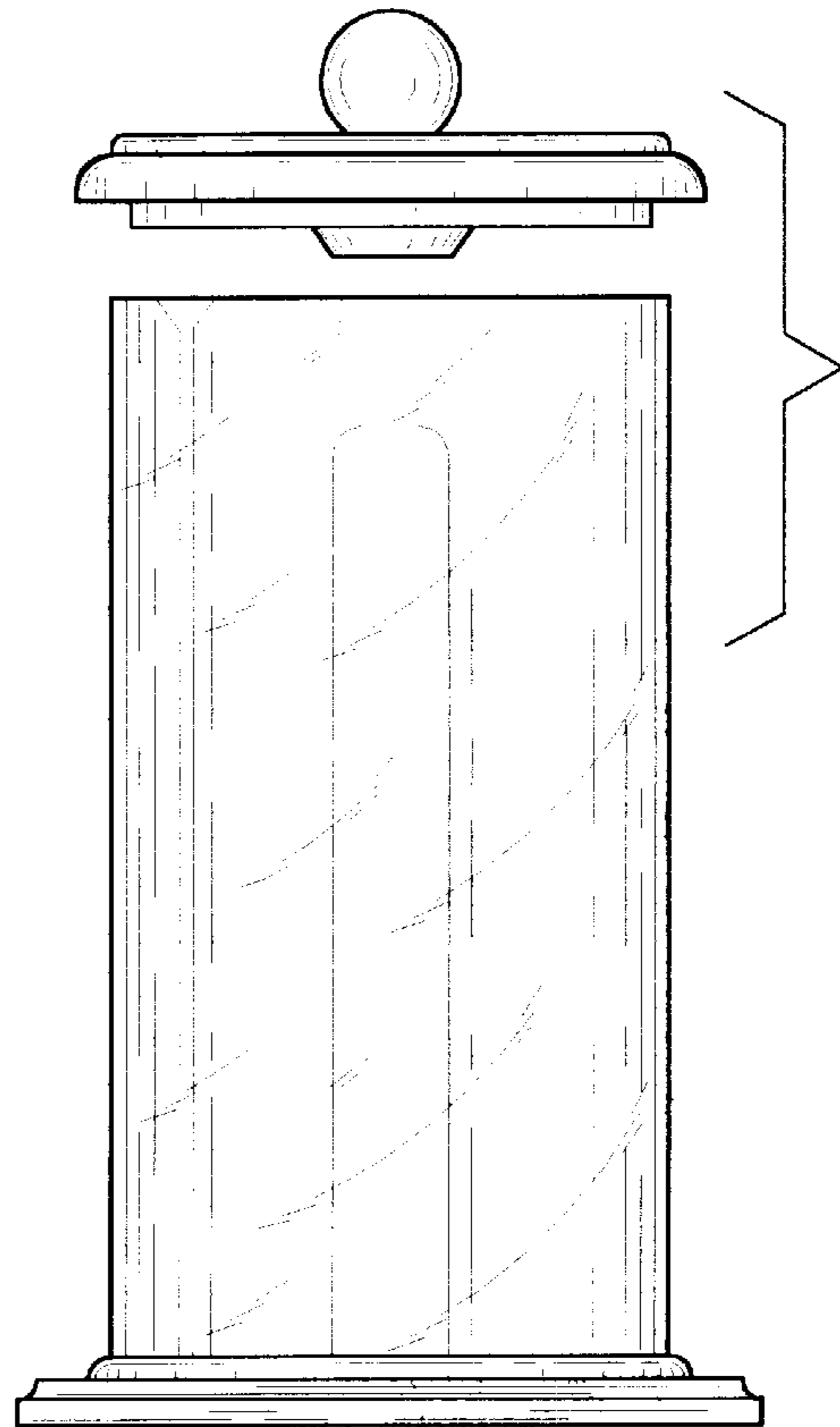
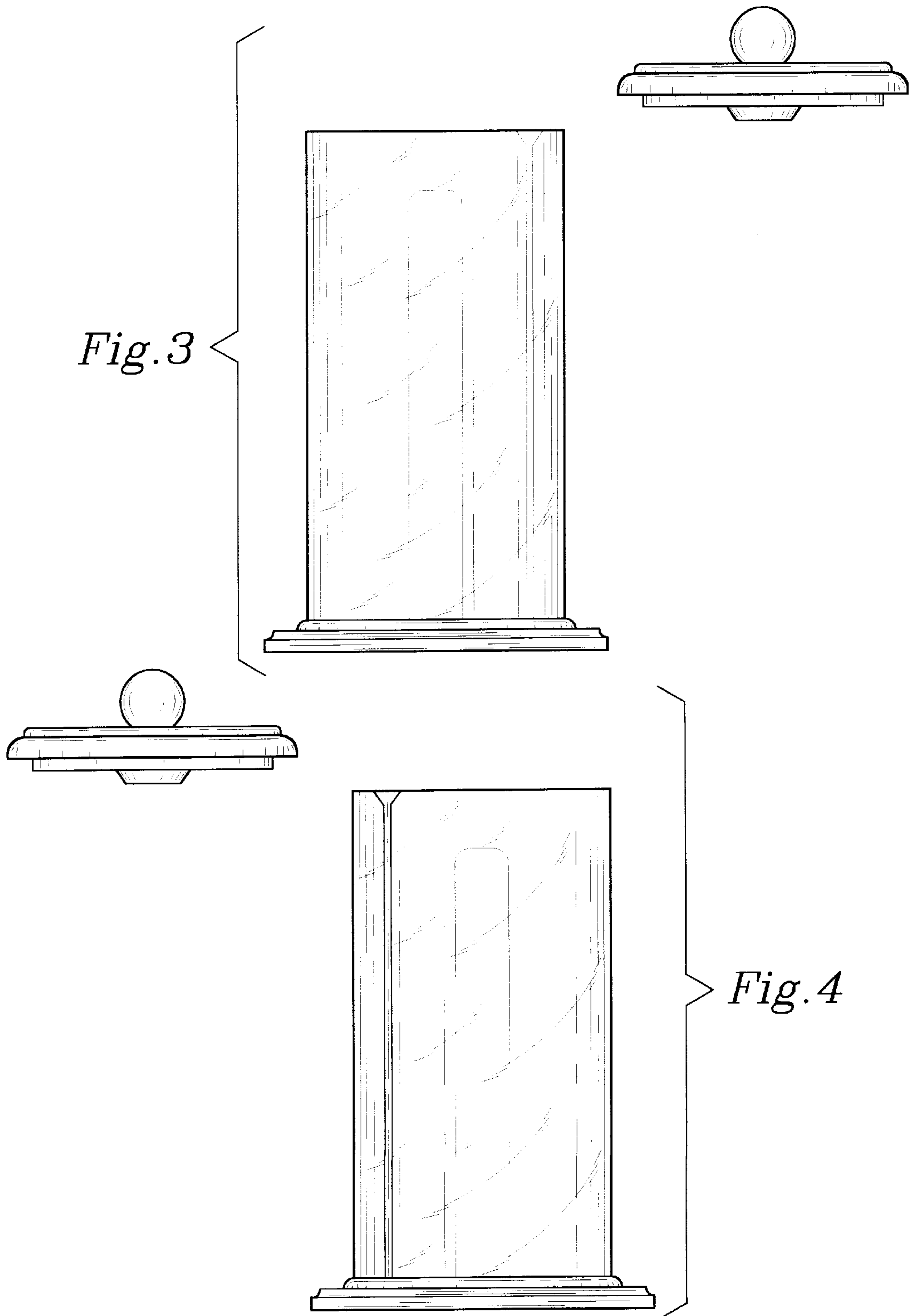

Fig. 2



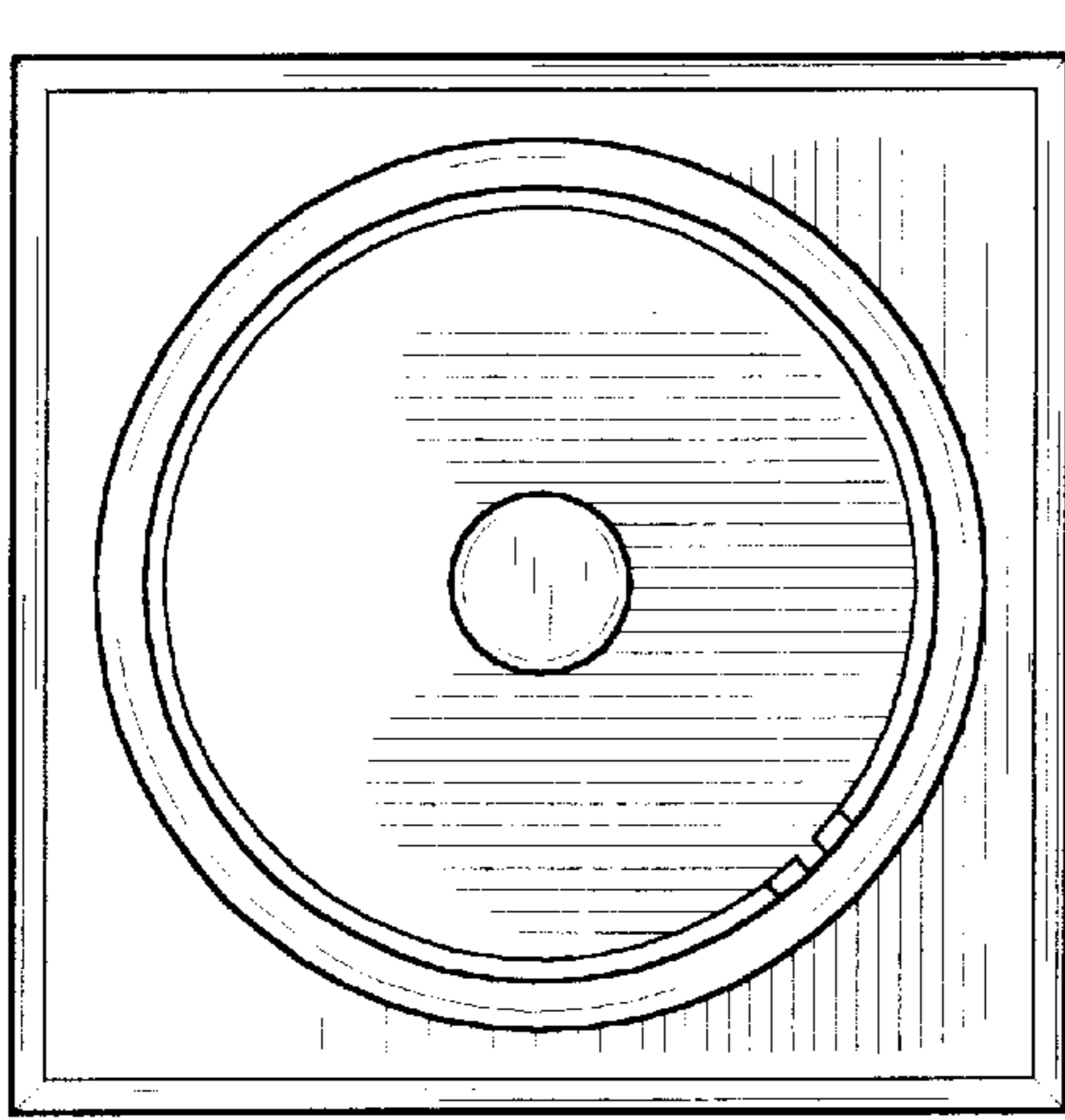

Fig. 5

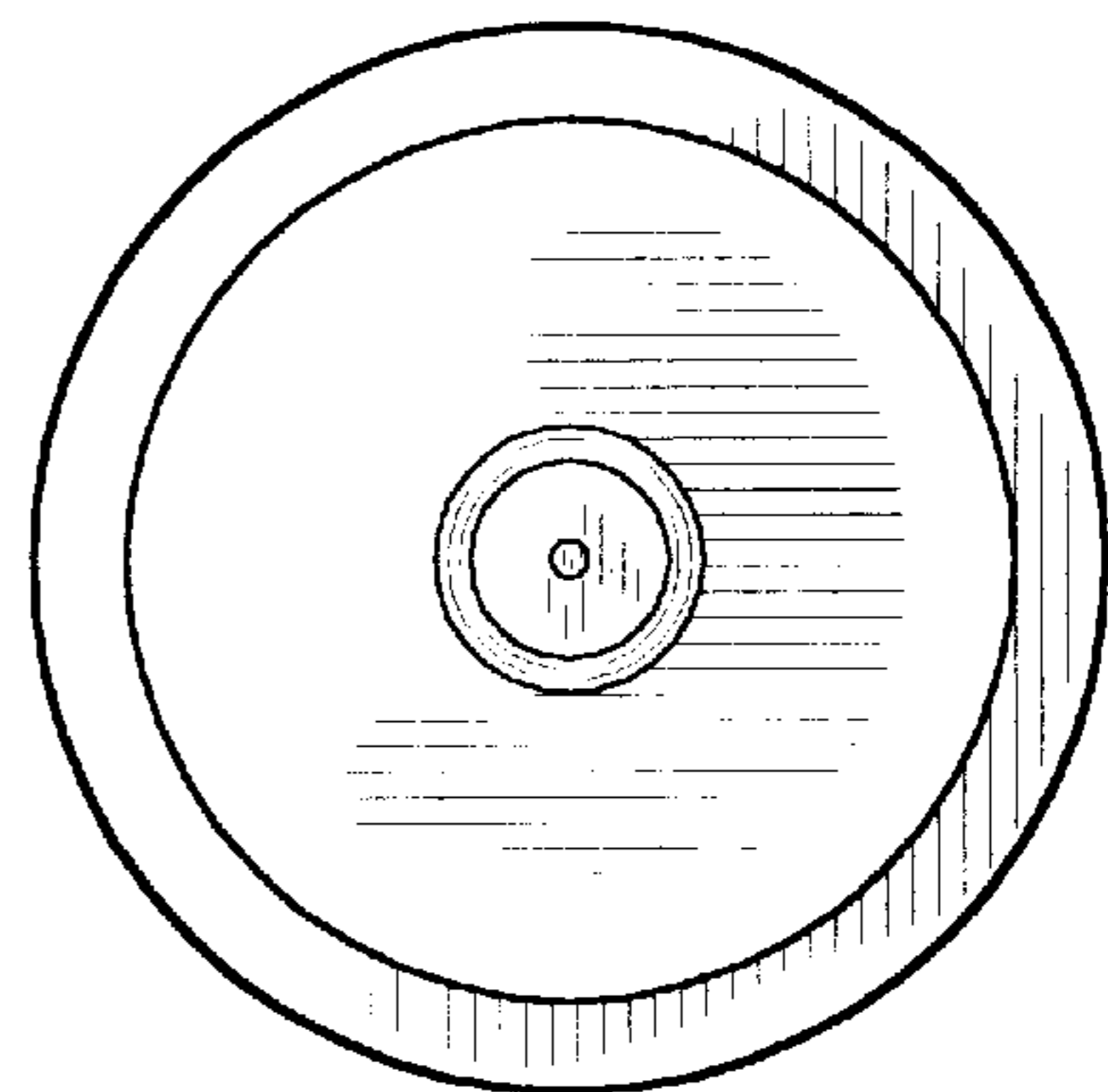
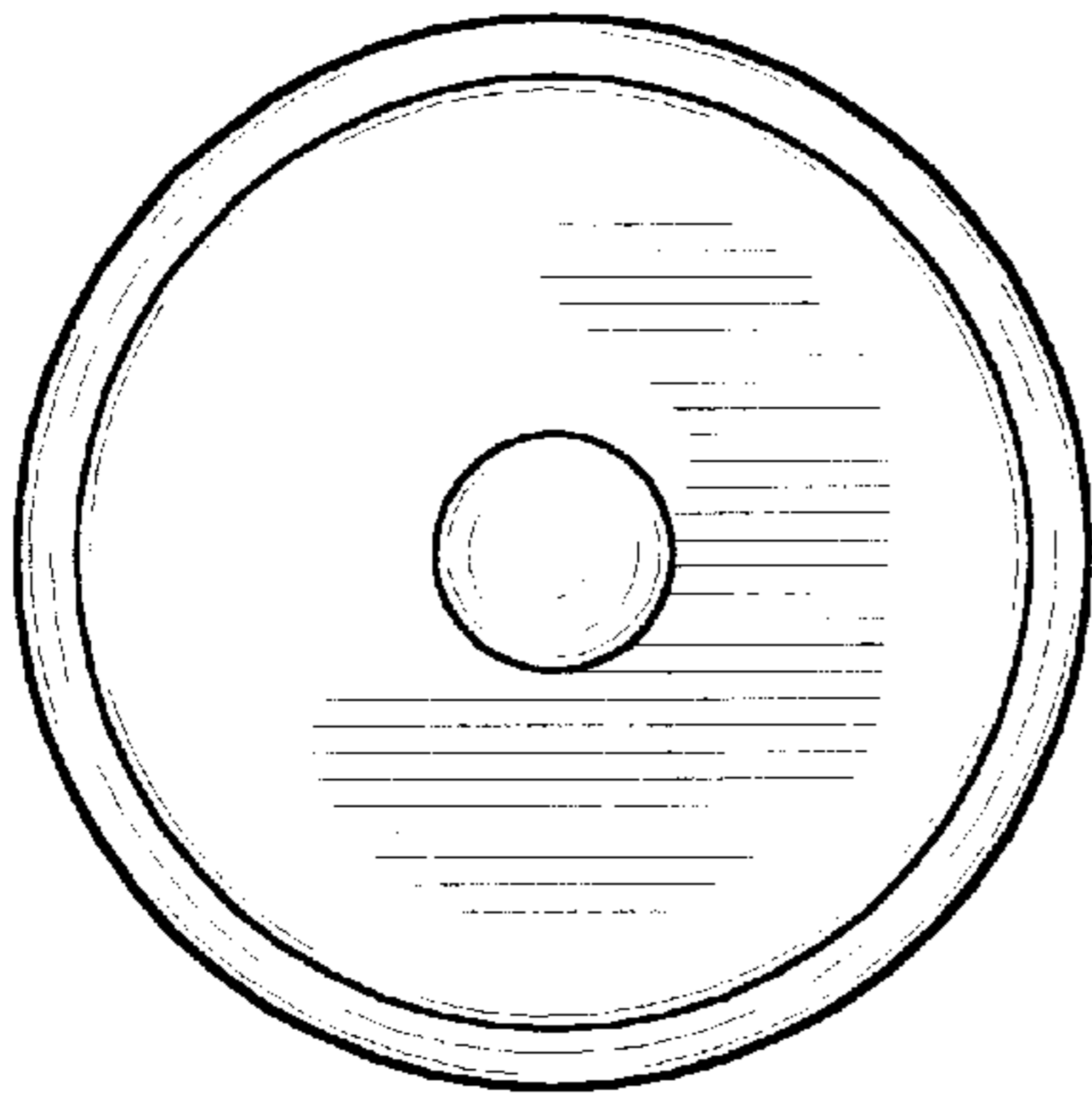
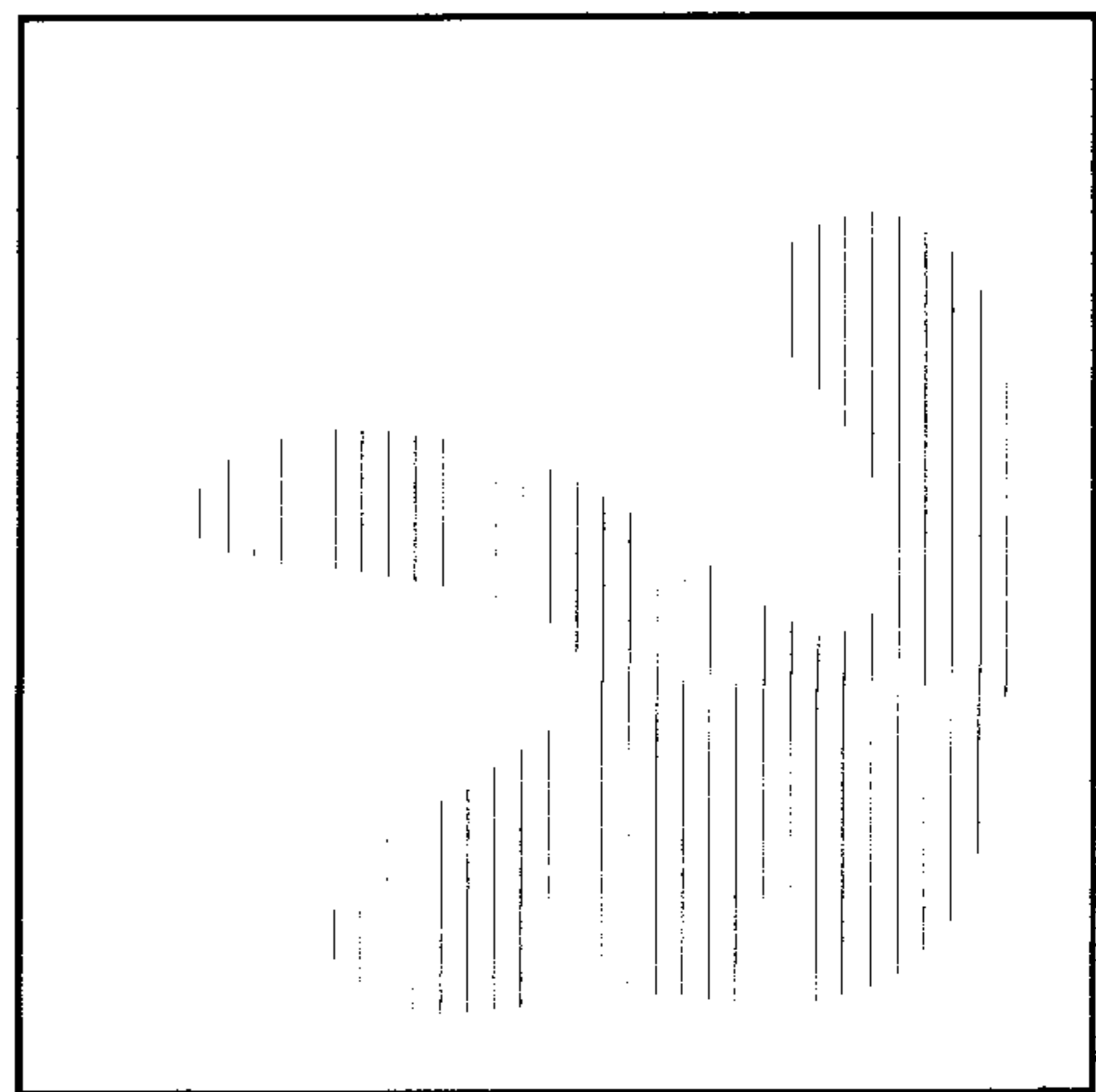

Fig. 6



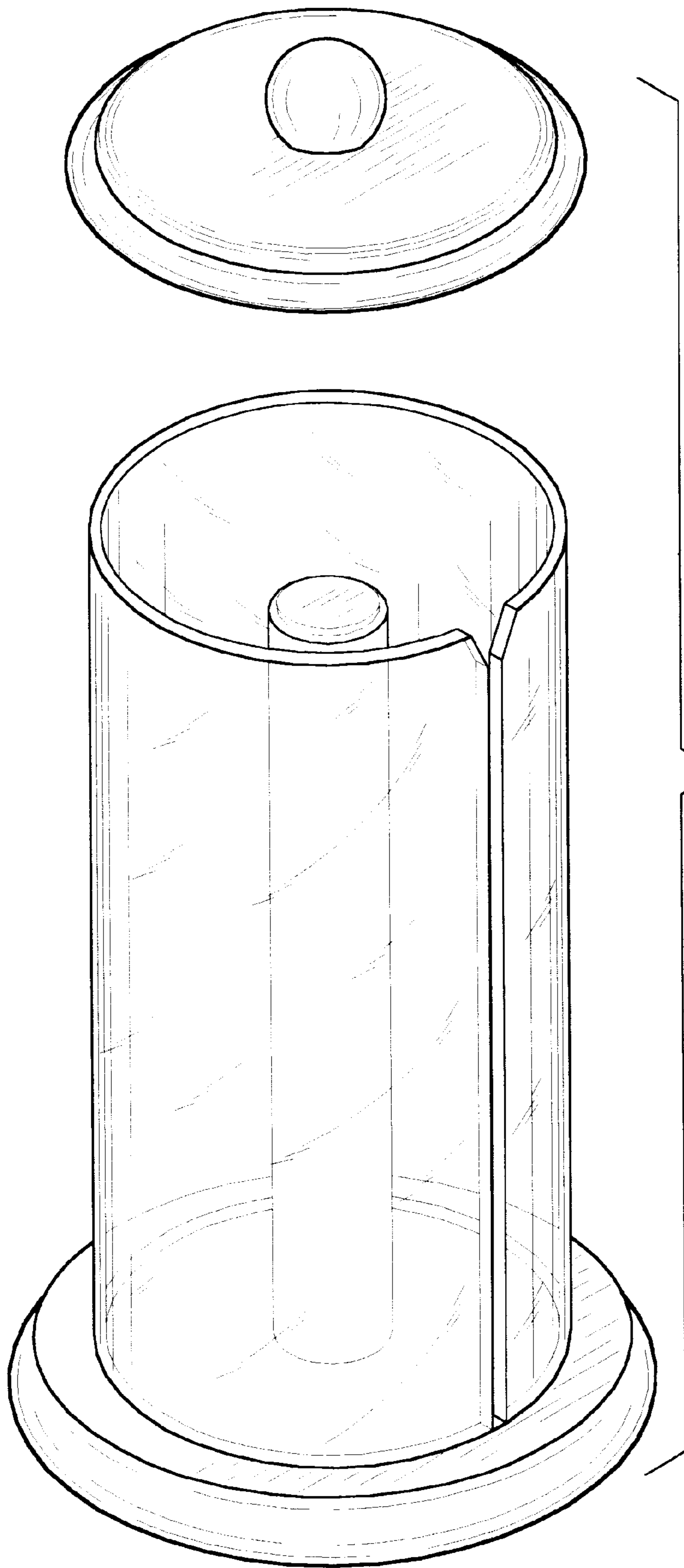

Fig. 7