



US00D422165S

# United States Patent [19] Baluk

[11] Patent Number: **Des. 422,165**

[45] Date of Patent: **\*\* Apr. 4, 2000**

[54] **LONG CANDY DISPLAY**

[75] Inventor: **Ray Baluk**, Cicero, Ill.

[73] Assignee: **Brach & Brock Confections, Inc.**,  
Chattanooga, Tenn.

[\*\*] Term: **14 Years**

[21] Appl. No.: **29/101,383**

[22] Filed: **Mar. 2, 1999**

[51] **LOC (6) Cl.** ..... **06-04**

[52] **U.S. Cl.** ..... **D6/474**

[58] **Field of Search** ..... D6/408, 481, 474-476,  
D6/432, 436-439; D25/16; D34/19-21;  
52/36.1-36.5; 312/117-119, 138.1, 140.1,  
140.2

[56] **References Cited**

**U.S. PATENT DOCUMENTS**

D. 158,776 5/1950 Malkin ..... D6/470

D. 363,086 10/1995 Vlastuin ..... D20/4  
D. 385,432 10/1997 Baluk et al. .... D6/476 X  
D. 385,433 10/1997 Baluk et al. .... D6/408 X  
D. 393,554 4/1998 Baluk et al. .... D6/470  
968,352 8/1910 Hermann ..... 312/3

*Primary Examiner*—Doris V. Coles  
*Assistant Examiner*—Linda Brooks  
*Attorney, Agent, or Firm*—Miller & Martin LLP

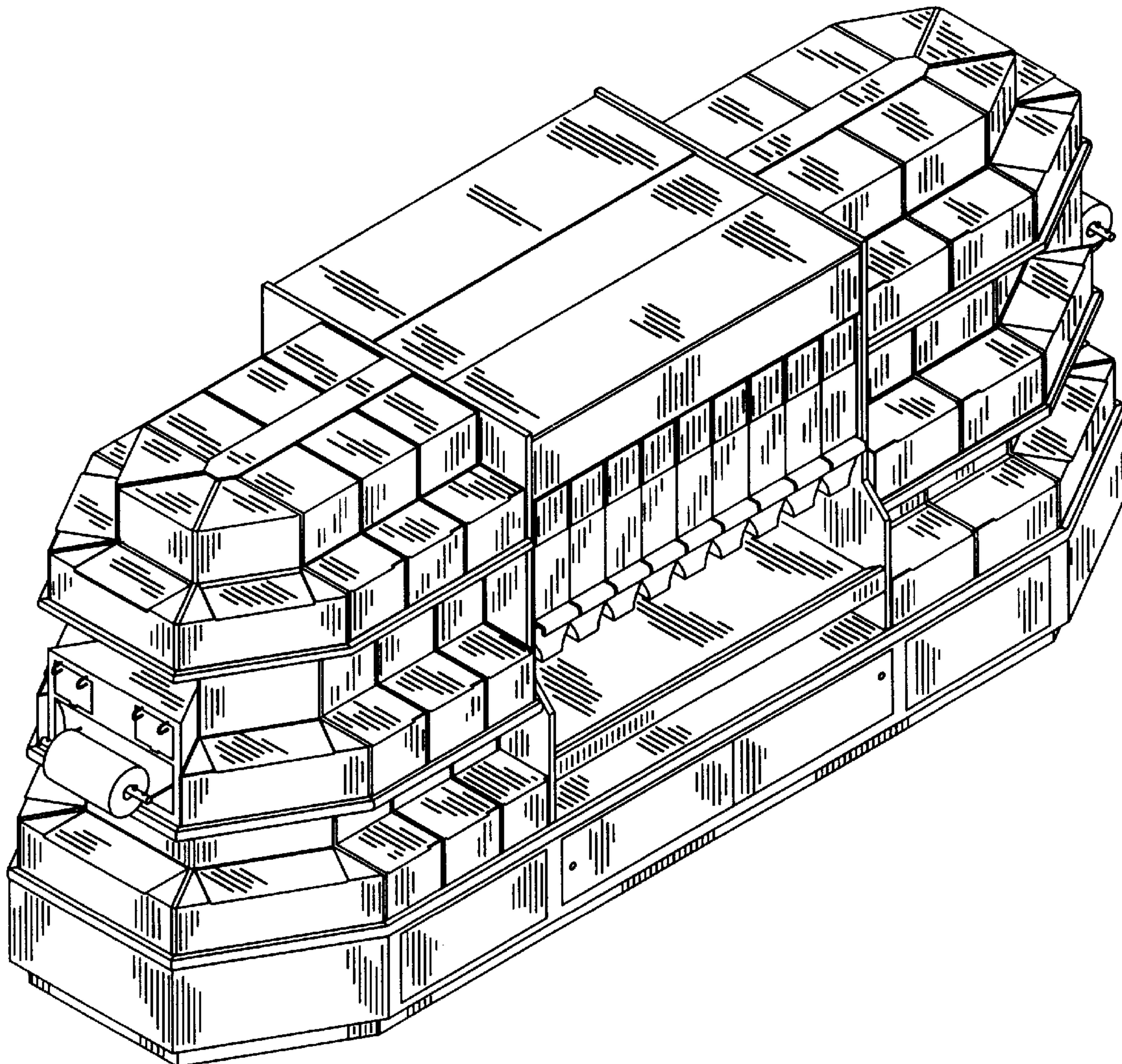
[57] **CLAIM**

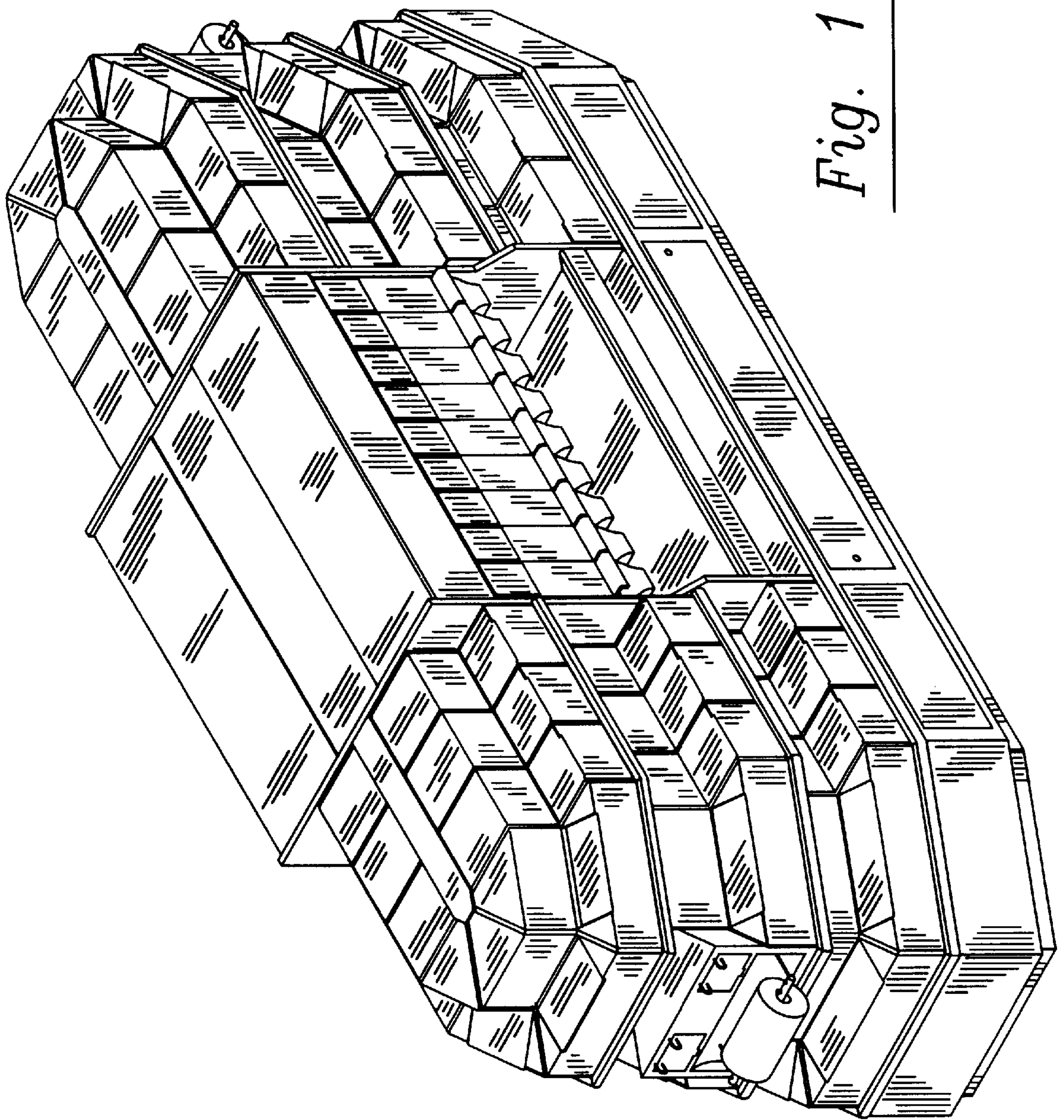
The ornamental design for a long candy display, as shown and described.

**DESCRIPTION**

FIG. 1 is a perspective view of the long candy display; FIG. 2 is a front elevational view; FIG. 3 is a back elevational view; FIG. 4 is a top plan view; FIG. 5 is a bottom plan view; FIG. 6 is a left elevational view; and, FIG. 7 is a right elevational view.

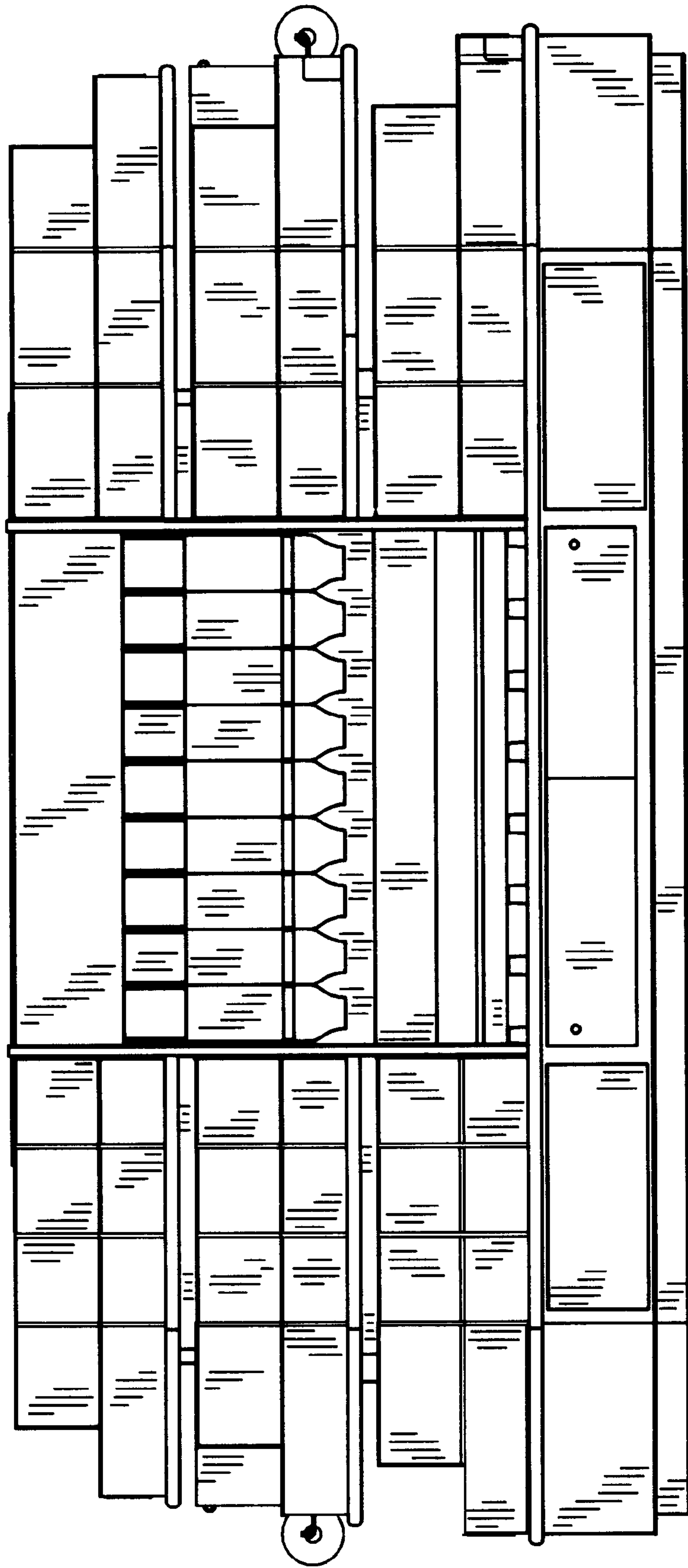
**1 Claim, 6 Drawing Sheets**



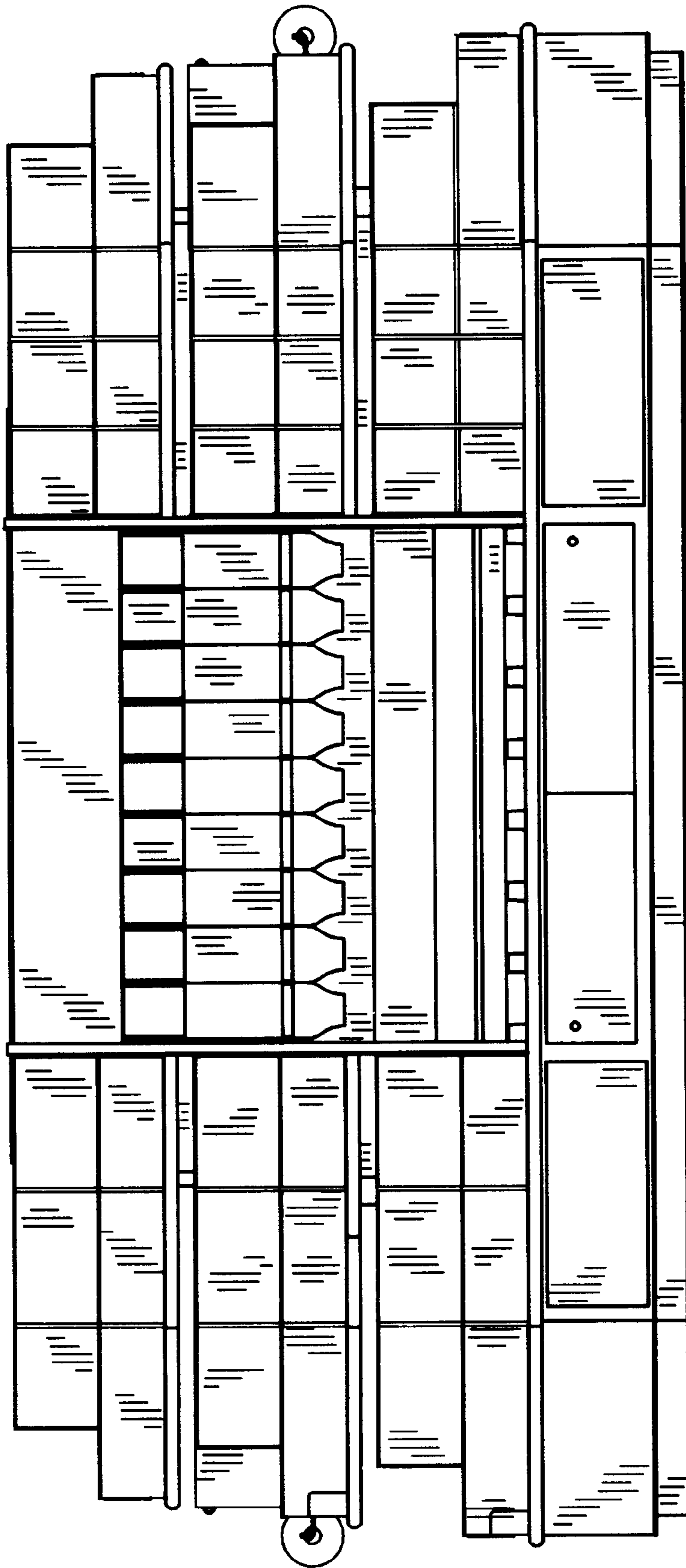


*Fig. 1*

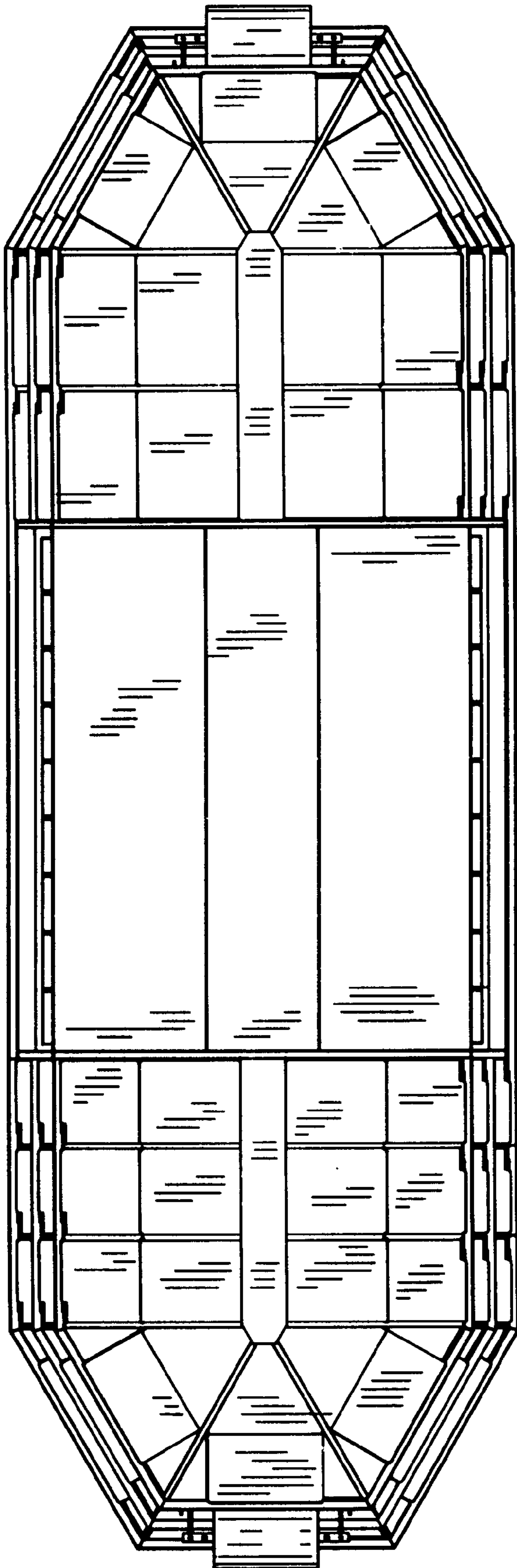




*Fig. 2*

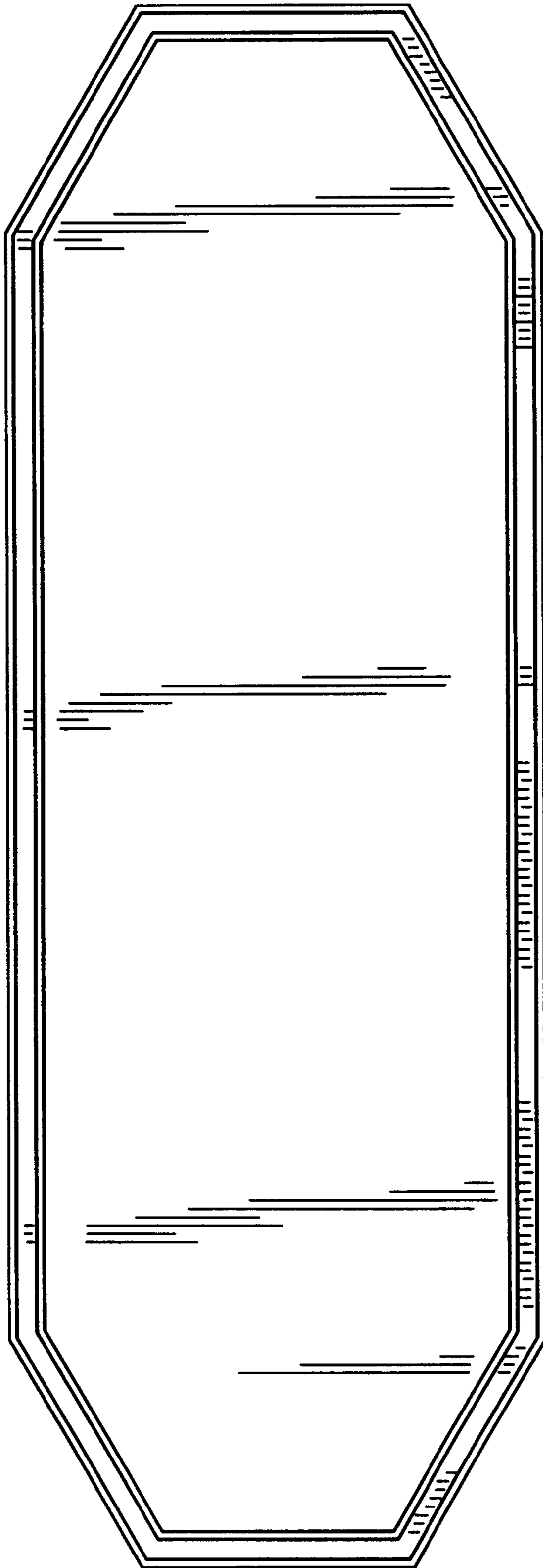


*Fig. 3*



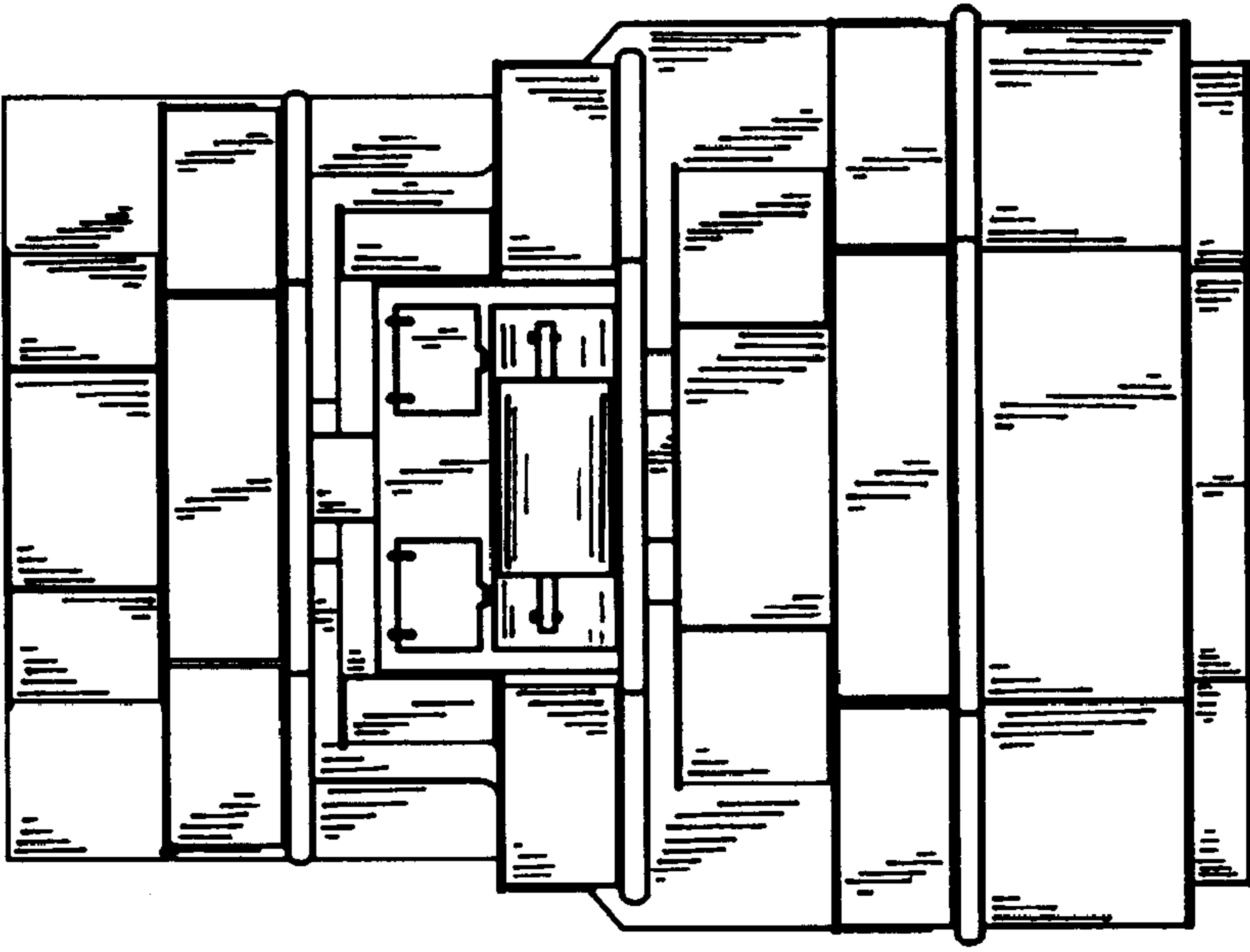
*Fig. 4*

---



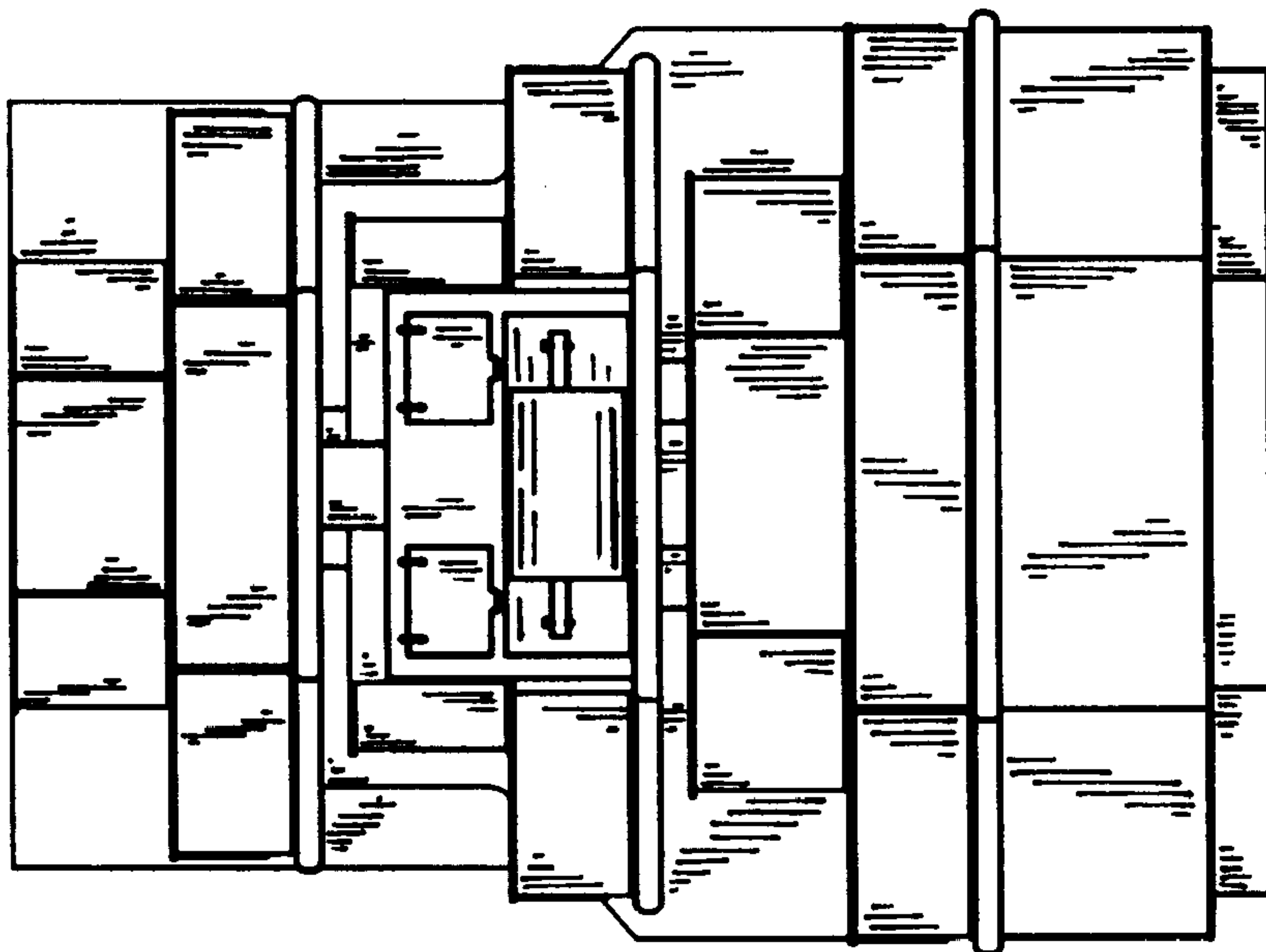
*Fig. 5*

---



*Fig. 7*

---



*Fig. 6*

---