



US00D422065S

**United States Patent** [19]  
**Kawamura**

[11] **Patent Number: Des. 422,065**

[45] **Date of Patent: \*\* Mar. 28, 2000**

[54] **WATER CLOSET**

[75] Inventor: **Sejiro Kawamura**, Fukuoka, Japan

[73] Assignee: **Toto, Ltd.**, Fukuoka, Japan

[\*\*] Term: **14 Years**

[21] Appl. No.: **29/099,962**

[22] Filed: **Feb. 1, 1999**

[51] **LOC (6) Cl.** ..... **23-02**

[52] **U.S. Cl.** ..... **D23/301**

[58] **Field of Search** ..... D23/295-301;  
4/538, 539, 546, 548, 353, 421, 424, 428,  
430

[56] **References Cited**

**U.S. PATENT DOCUMENTS**

D. 261,171	10/1981	Cuttriss	.....	D23/301
D. 323,551	1/1992	Fait	.....	D23/301
D. 352,996	11/1994	Sim	.....	D23/301
D. 387,858	12/1997	McKeone	.....	D23/301
D. 392,075	3/1998	Holt	.....	D30/129
D. 396,272	7/1998	Garza	.....	D23/301

D. 407,150	3/1999	Sim	.....	D23/301
D. 407,151	3/1999	Chiu	.....	D23/301
D. 409,734	5/1999	Sim	.....	D23/301

*Primary Examiner*—Eric Watterson  
*Attorney, Agent, or Firm*—Birch, Stewart, Kolasch & Birch, LLP

[57] **CLAIM**

The ornamental design for an water closet, as shown and described.

**DESCRIPTION**

FIG. 1 is a perspective view of an water closet showing my new design;  
FIG. 2 is a left side view thereof, a right side view being a mirror image of the right view;  
FIG. 3 is a front elevational view thereof;  
FIG. 4 is a rear elevational view thereof;  
FIG. 5 is a top plan view thereof;  
FIG. 6 is a bottom plan view thereof; and,  
FIG. 7 is a cross-sectional view thereof taken along line 7—7 in FIG. 5.

**1 Claim, 7 Drawing Sheets**

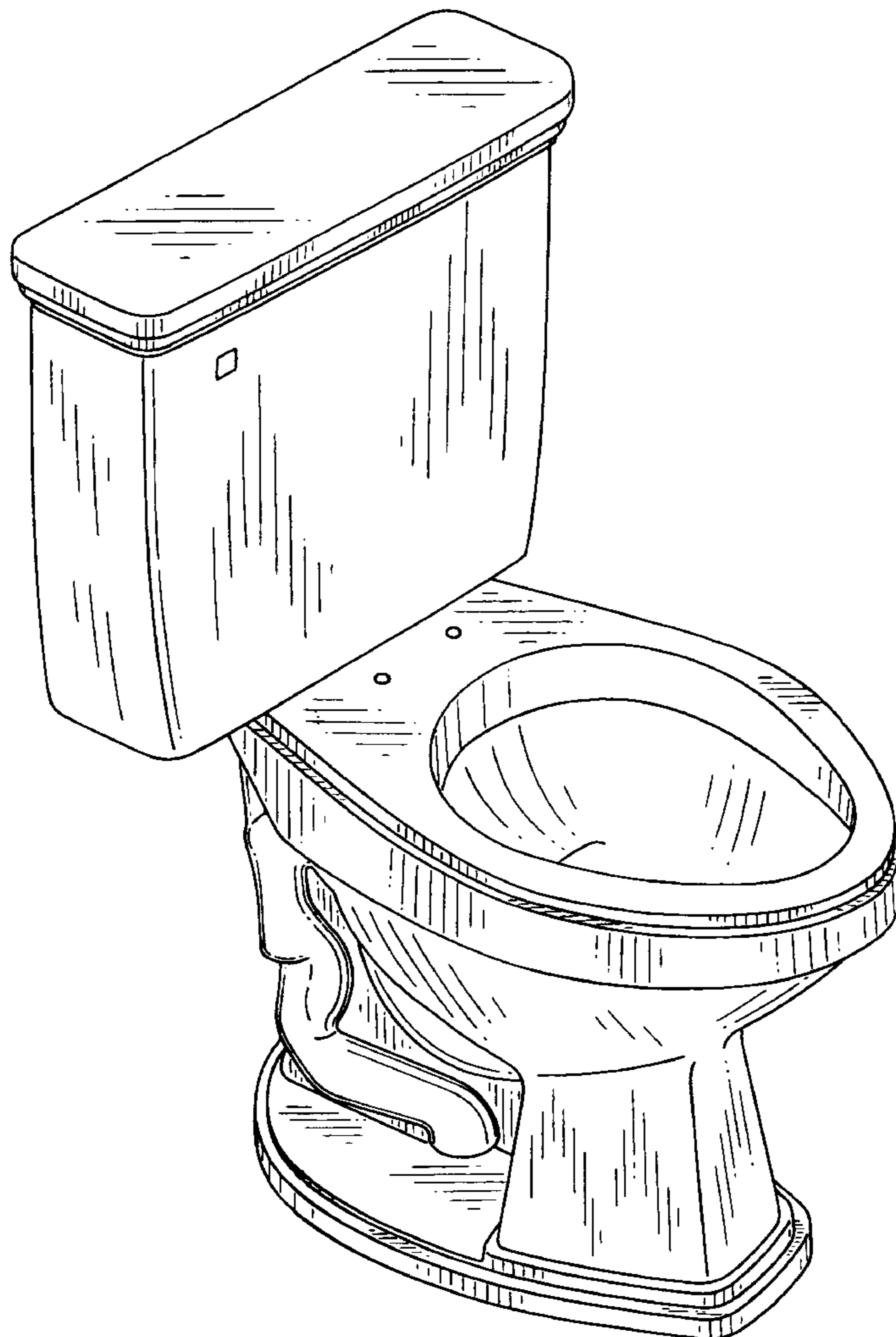

FIG. 1

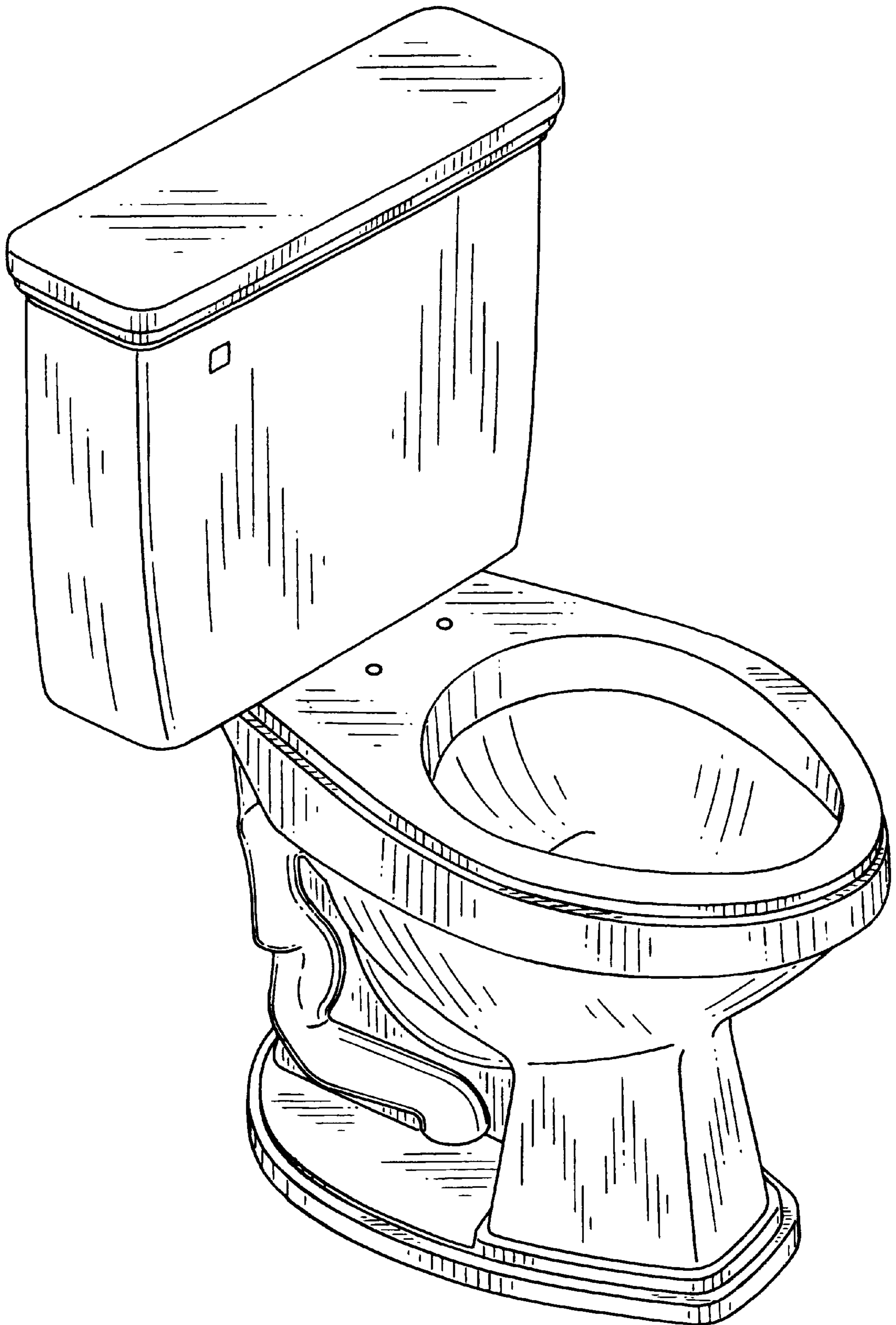

FIG. 2

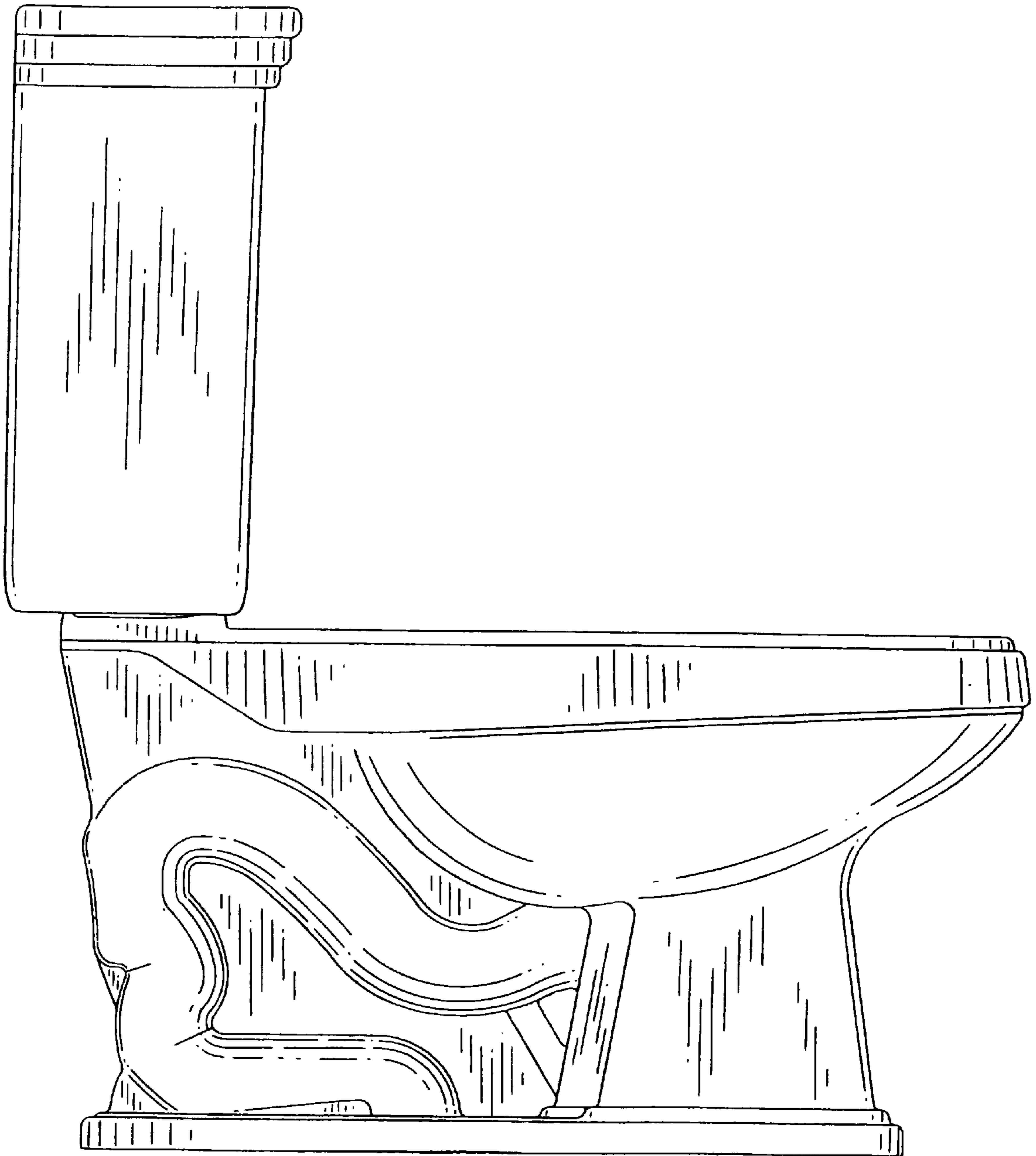

FIG. 3

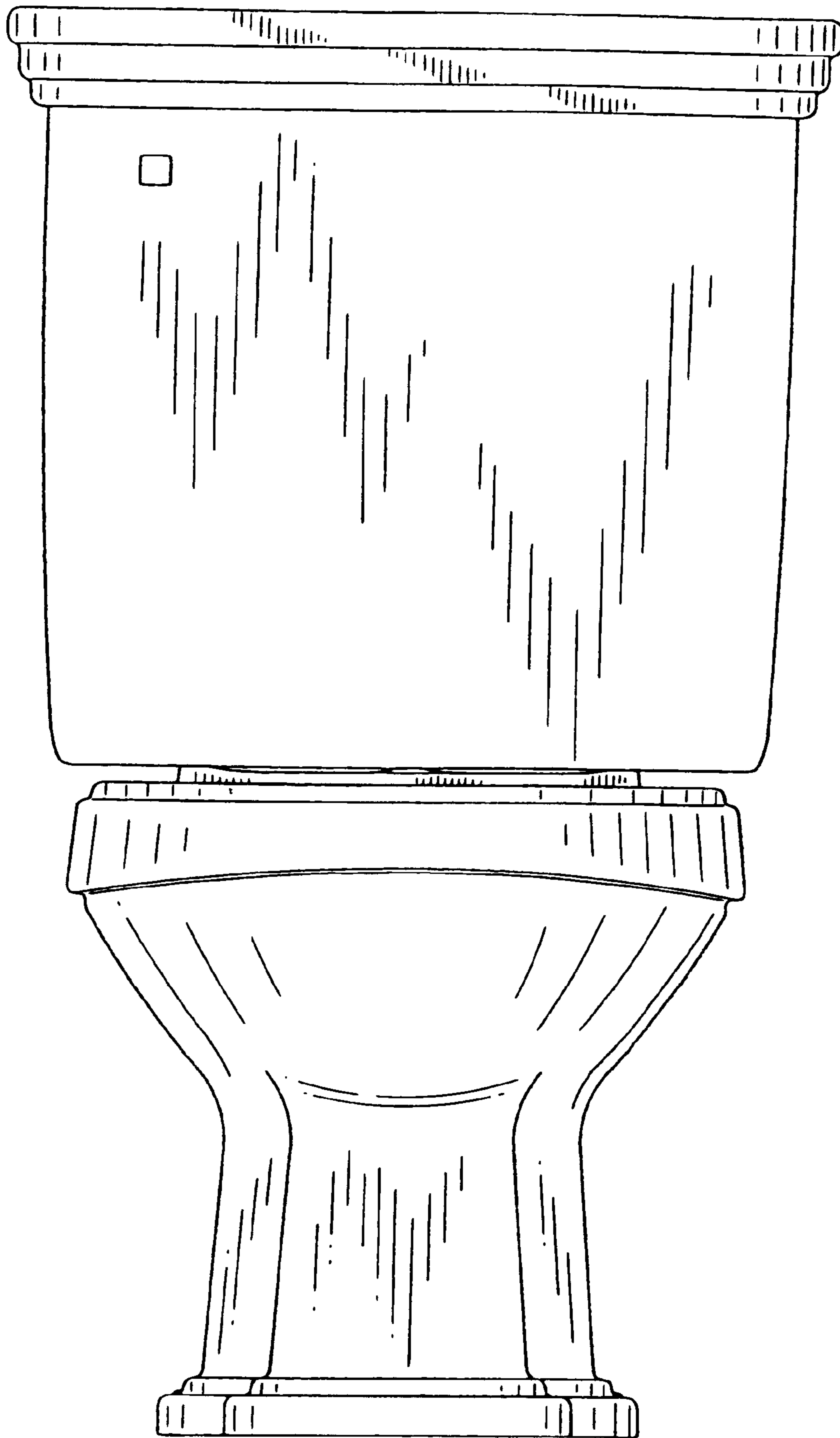

FIG. 4

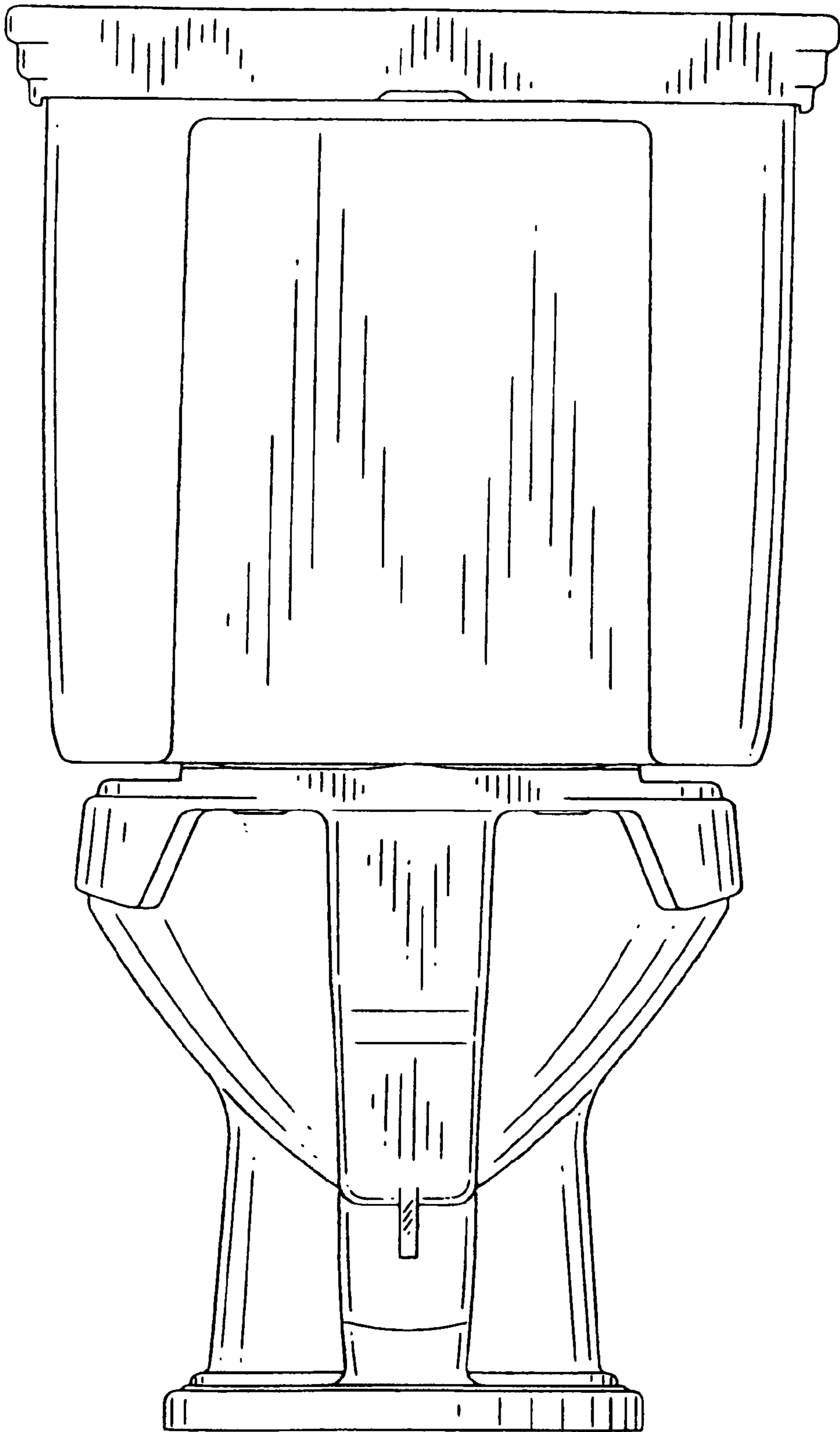

FIG. 5

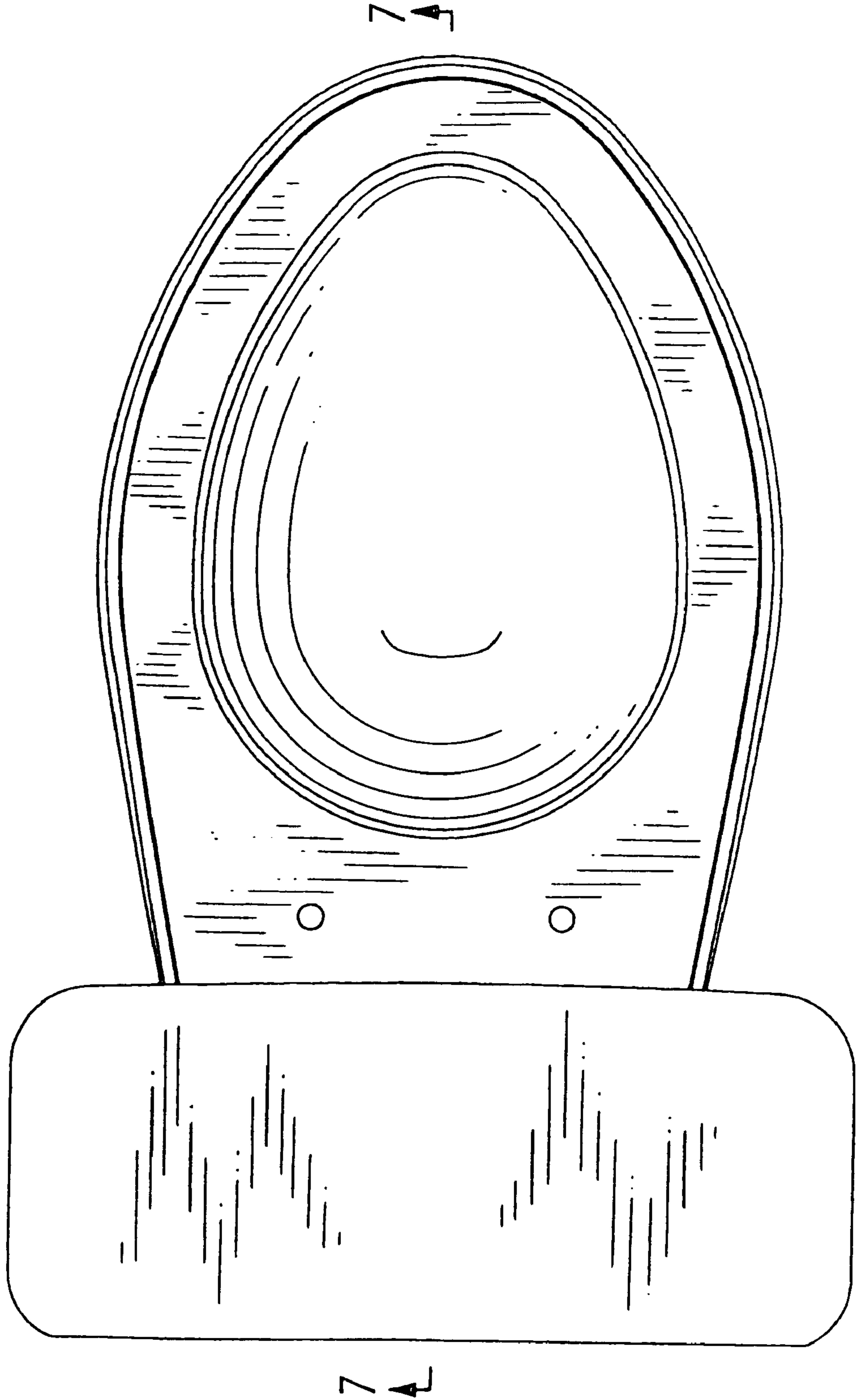

FIG. 6

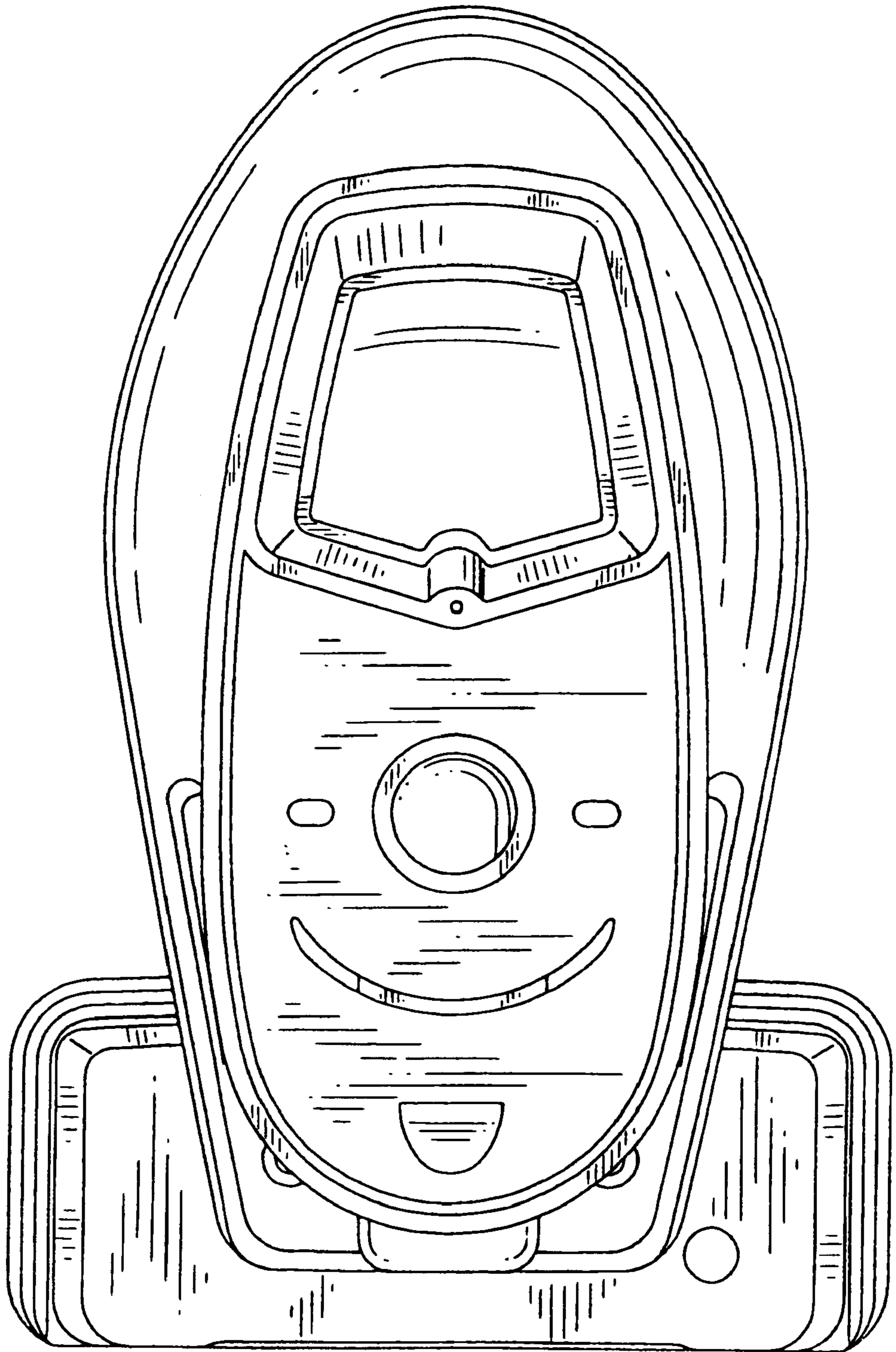

FIG. 7

