



US00D422029S

United States Patent [19] Goto

[11] **Patent Number: Des. 422,029**

[45] **Date of Patent: ** Mar. 28, 2000**

[54] **GAME MACHINE**

[75] Inventor: **Teiyu Goto**, Tokyo, Japan

[73] Assignee: **Sony Computer Entertainment Inc.**,
Tokyo, Japan

[**] Term: **14 Years**

[21] Appl. No.: **29/099,765**

[22] Filed: **Jan. 28, 1999**

[51] **LOC (6) Cl.** **21-01**

[52] **U.S. Cl.** **D21/329**

[58] **Field of Search** D21/324, 329-331,
D21/333; D14/117.1, 117.9, 114; 273/148 B;
463/1-4, 29-30, 46, 47

[56] **References Cited**

U.S. PATENT DOCUMENTS

D. 376,822	12/1996	Osterhout	D21/329
D. 383,798	9/1997	Yokoi et al.	D21/331
D. 399,267	10/1998	Fai	D21/329
D. 401,297	11/1998	Fai	D21/329
D. 405,125	2/1999	Yokoi	D21/329
D. 407,760	4/1999	Yokoi	D21/329
D. 410,500	6/1999	Toma et al.	D21/329
5,046,739	9/1991	Reichow	273/148 B X
5,161,803	11/1992	Ohara	463/46 X
5,184,830	2/1993	Okada et al.	463/29

OTHER PUBLICATIONS

Hongkong Enterprise, p. 133, Oct. 1994.
Hongkong Enterprise, p. 1183, Jan. 1998.
"The Point Network No. 39," (Dec. 20, 1997).

Advertisement Flyer of Itoyaokado for Jan. 1-4, 1999.

Primary Examiner—Prabhakar Deshmukh
Attorney, Agent, or Firm—Foley & Lardner

[57] **CLAIM**

The ornamental design for a game machine, as shown and described.

DESCRIPTION

FIG. 1 is a perspective view of a first embodiment of a game machine showing my new design;

FIG. 2 is a top plan view thereof;

FIG. 3 is a left side elevational view thereof;

FIG. 4 is a front elevational view thereof;

FIG. 5 is a bottom plan view thereof;

FIG. 6 is a right side elevational view thereof; and,

FIG. 7 is a rear elevational view thereof.

FIG. 8 is a perspective view of a second embodiment of a game machine showing my new design;

FIG. 9 is a top plan view thereof;

FIG. 10 is a left side elevational view thereof;

FIG. 11 is a front elevational view thereof;

FIG. 12 is a bottom plan view thereof;

FIG. 13 is a right side elevational view thereof; and,

FIG. 14 is a rear elevational view thereof.

1 Claim, 6 Drawing Sheets

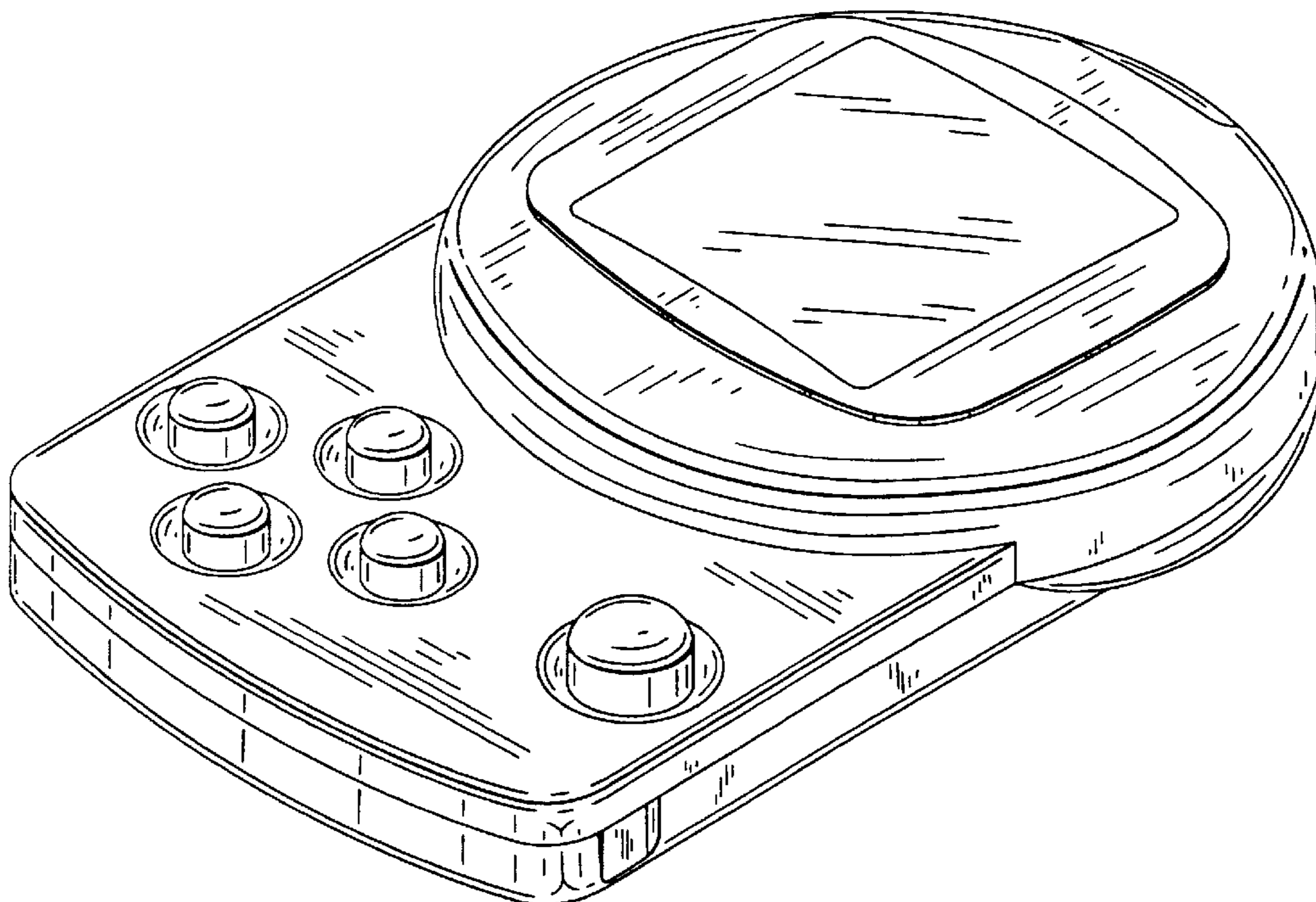

FIG. 1

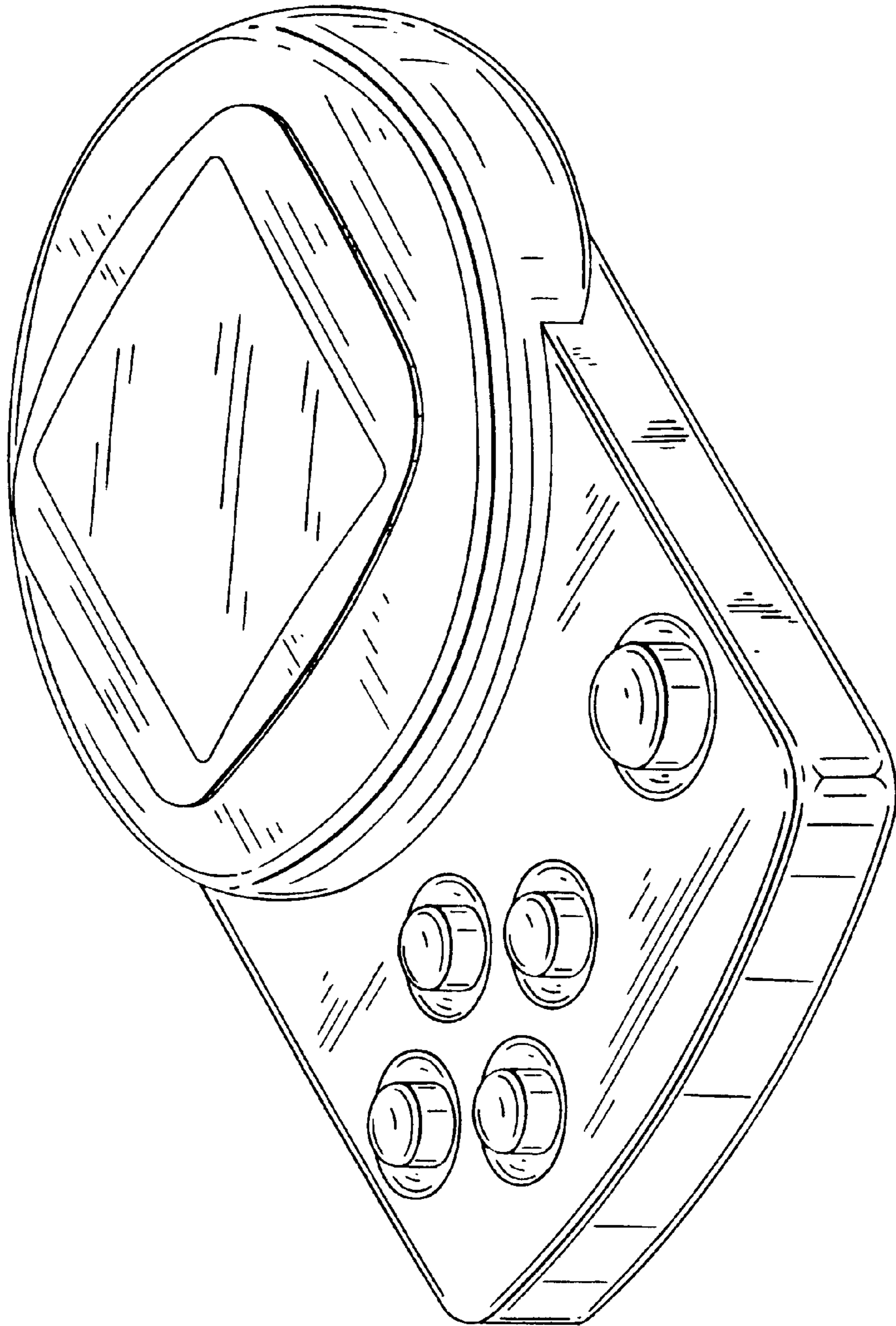

FIG. 2

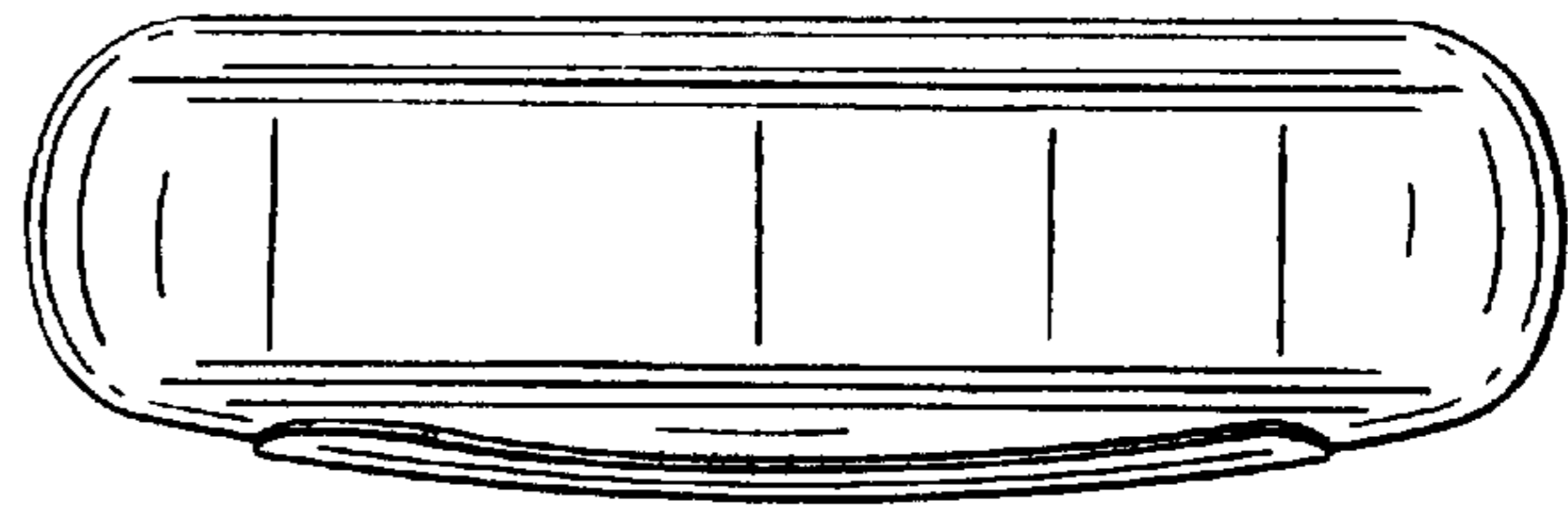

FIG. 3

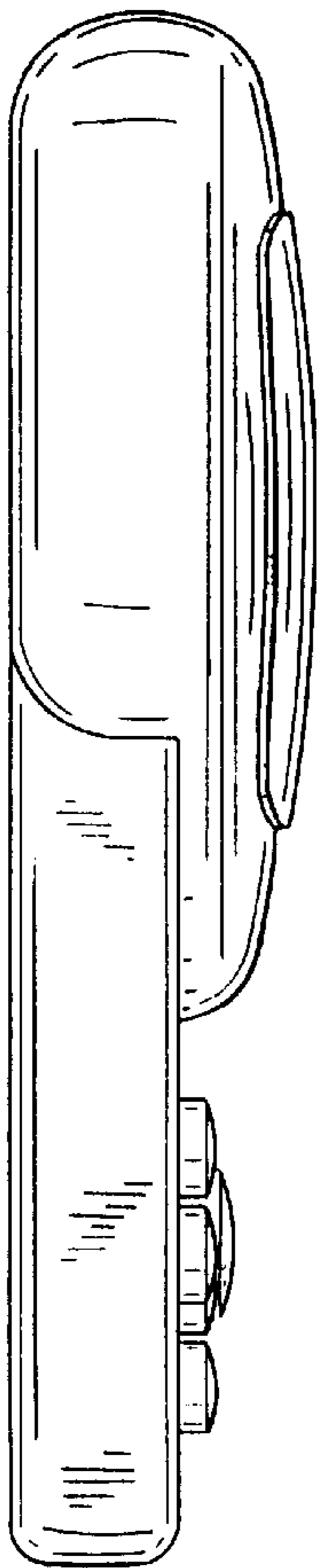

FIG. 4

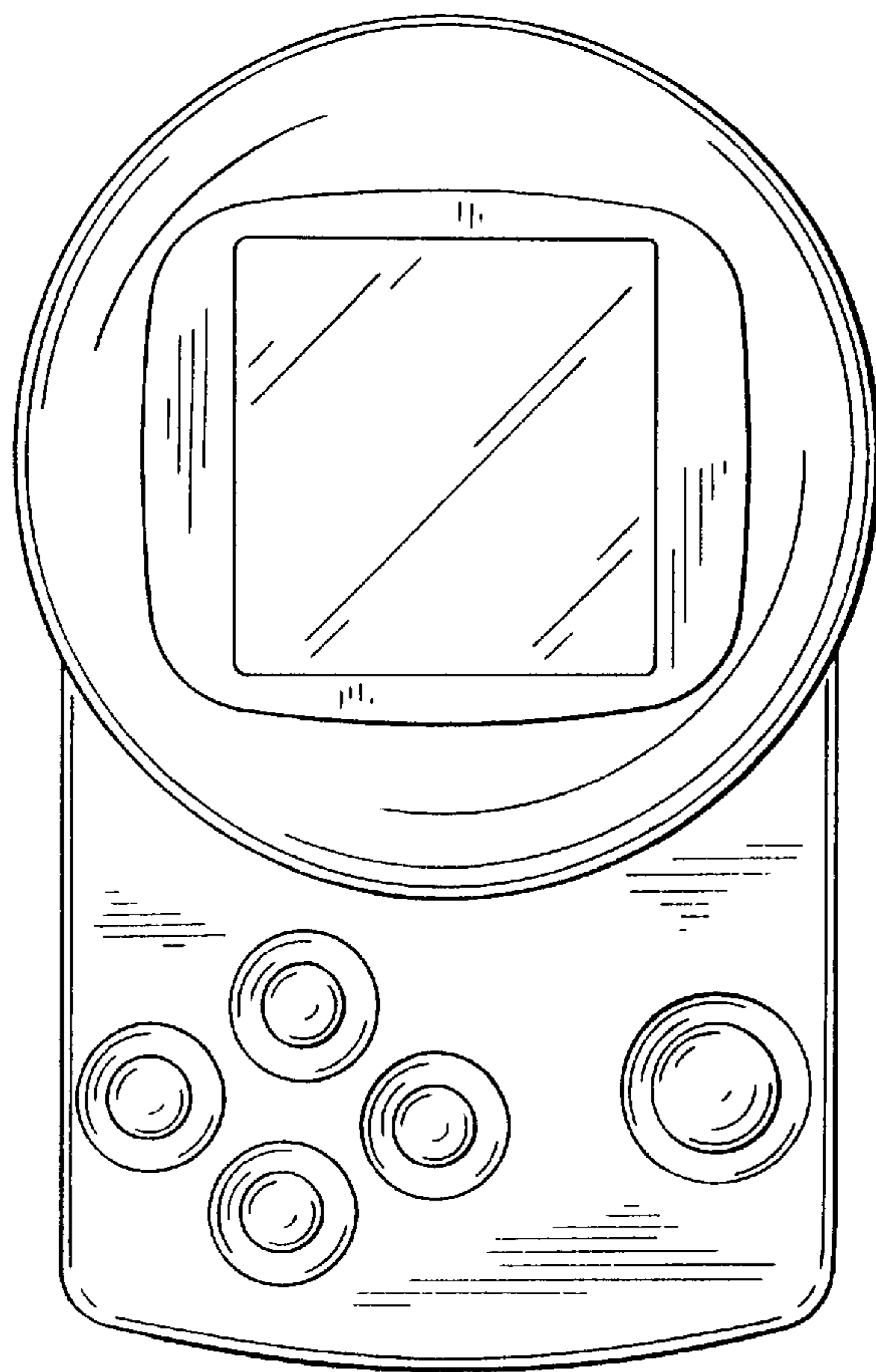

FIG. 6

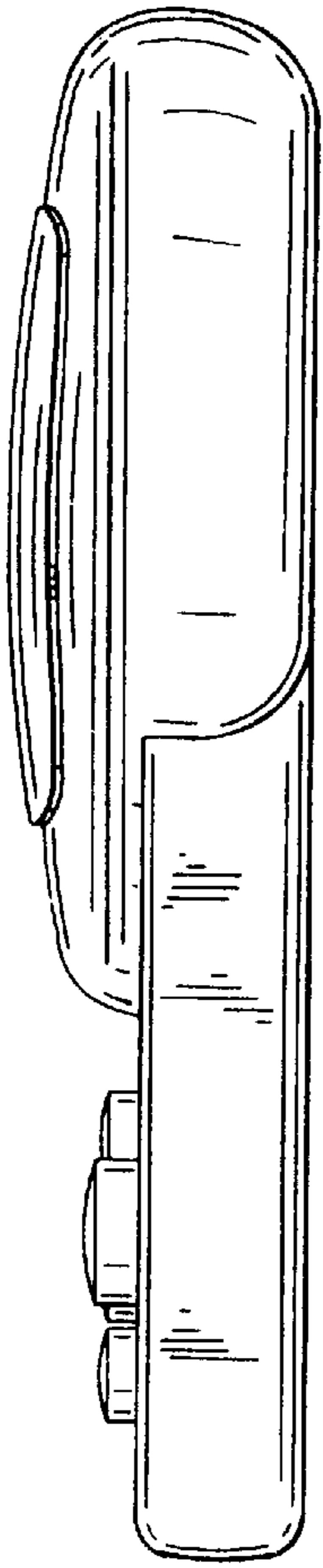

FIG. 7

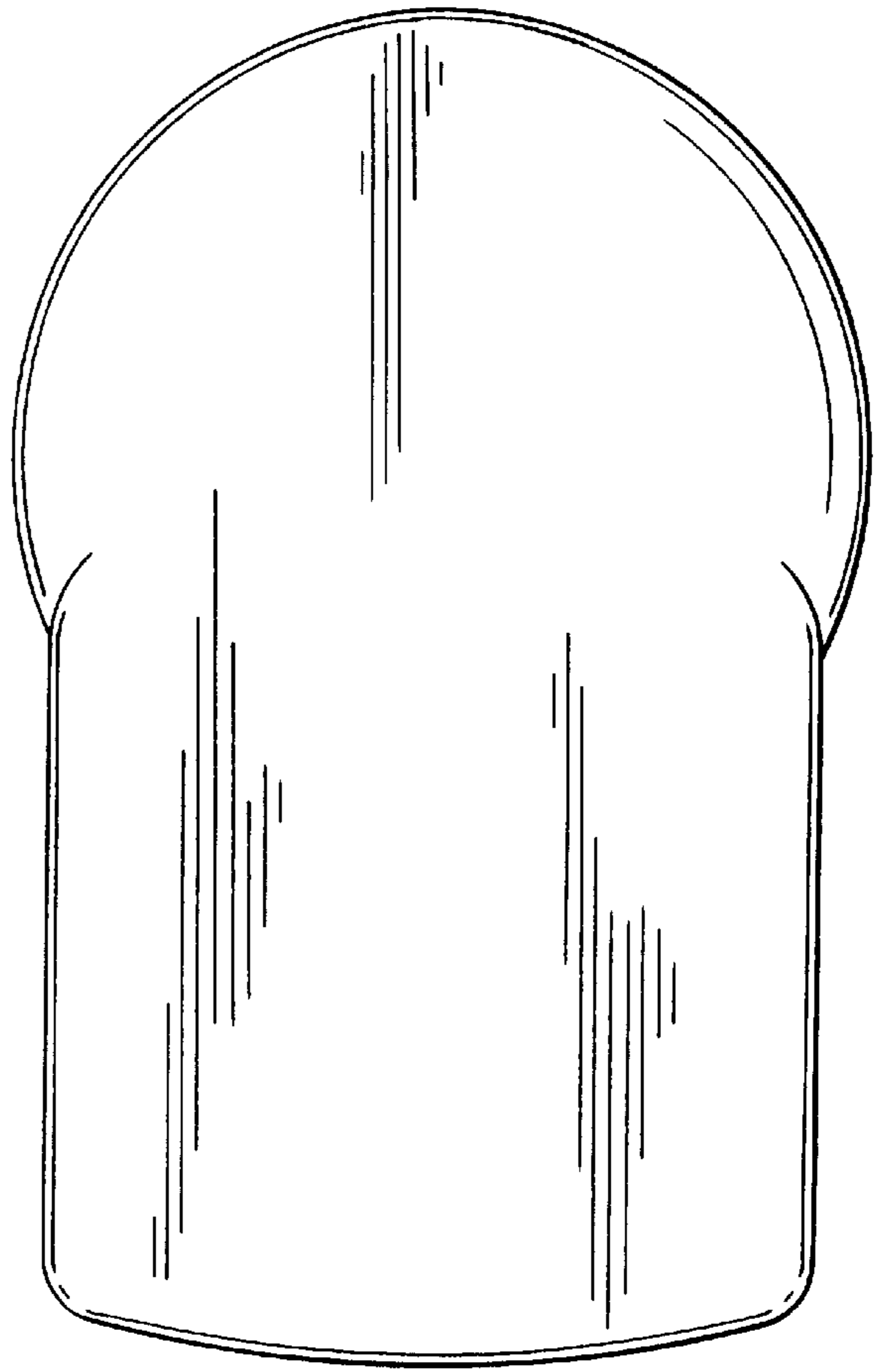

FIG. 5

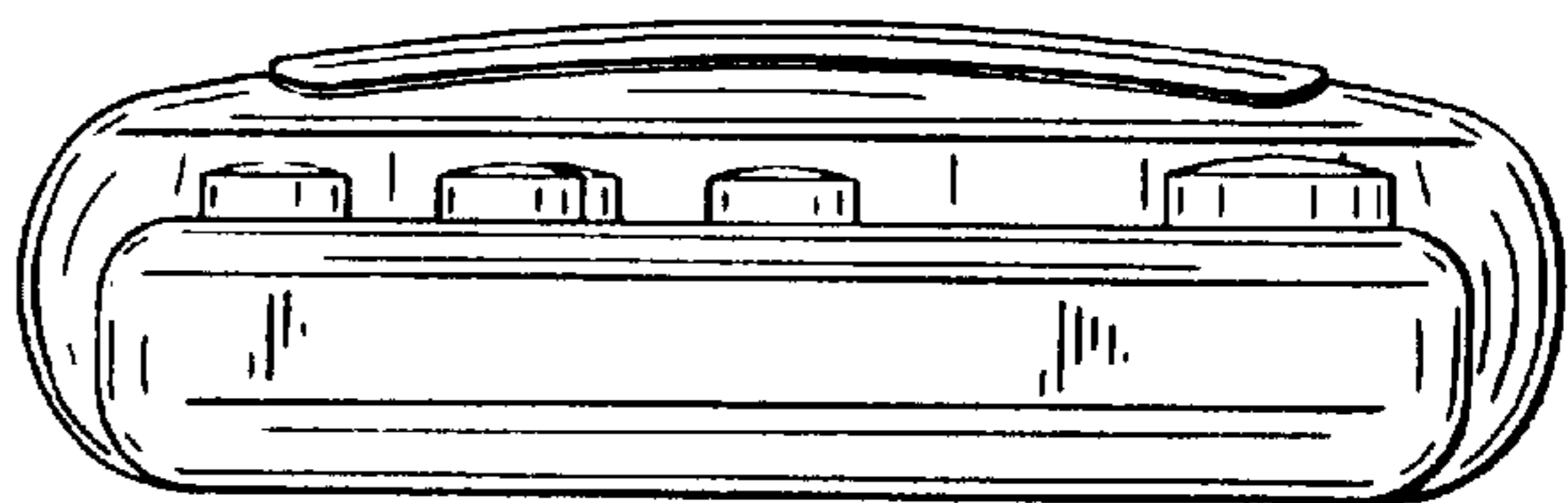

FIG. 8

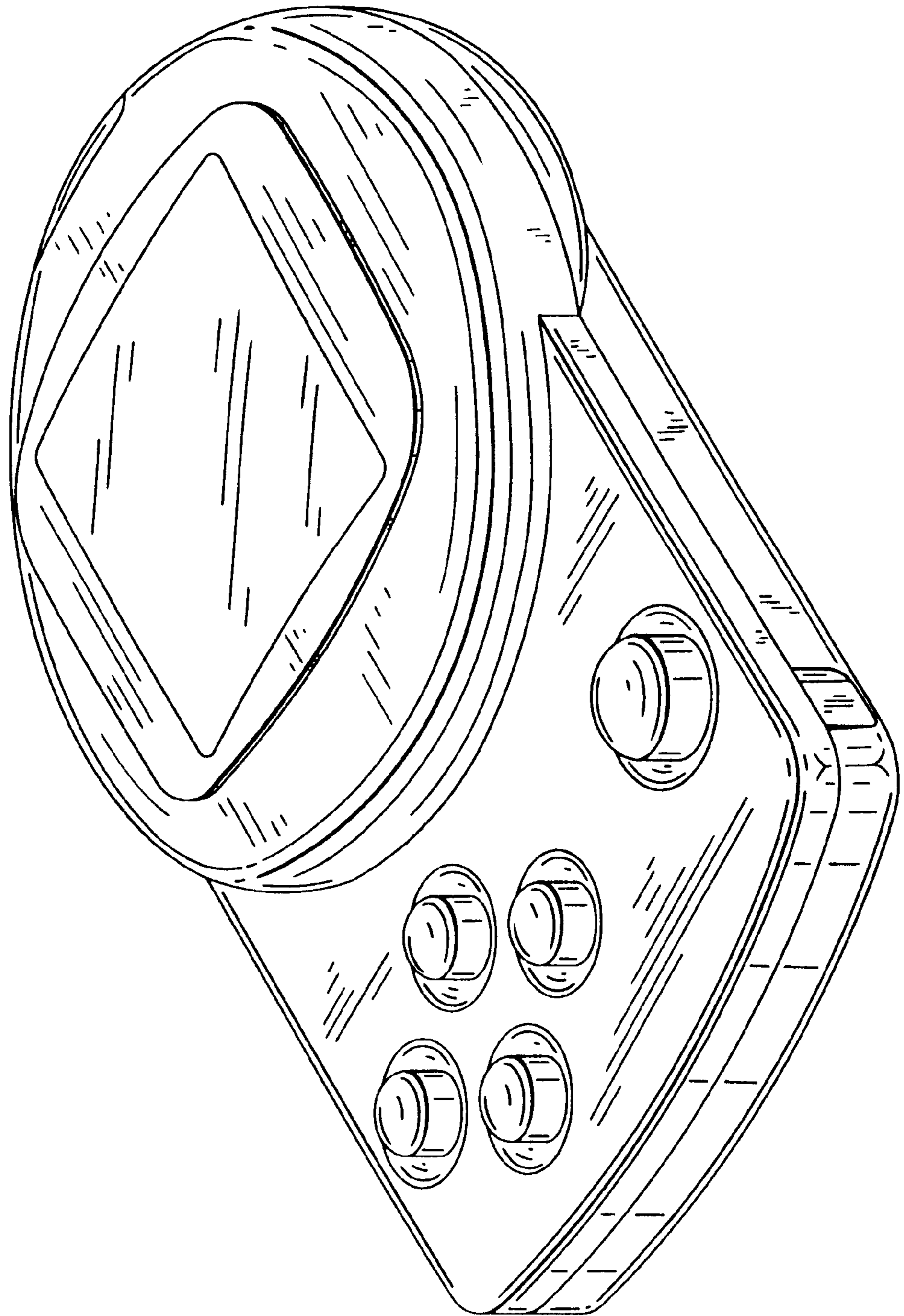

FIG. 9

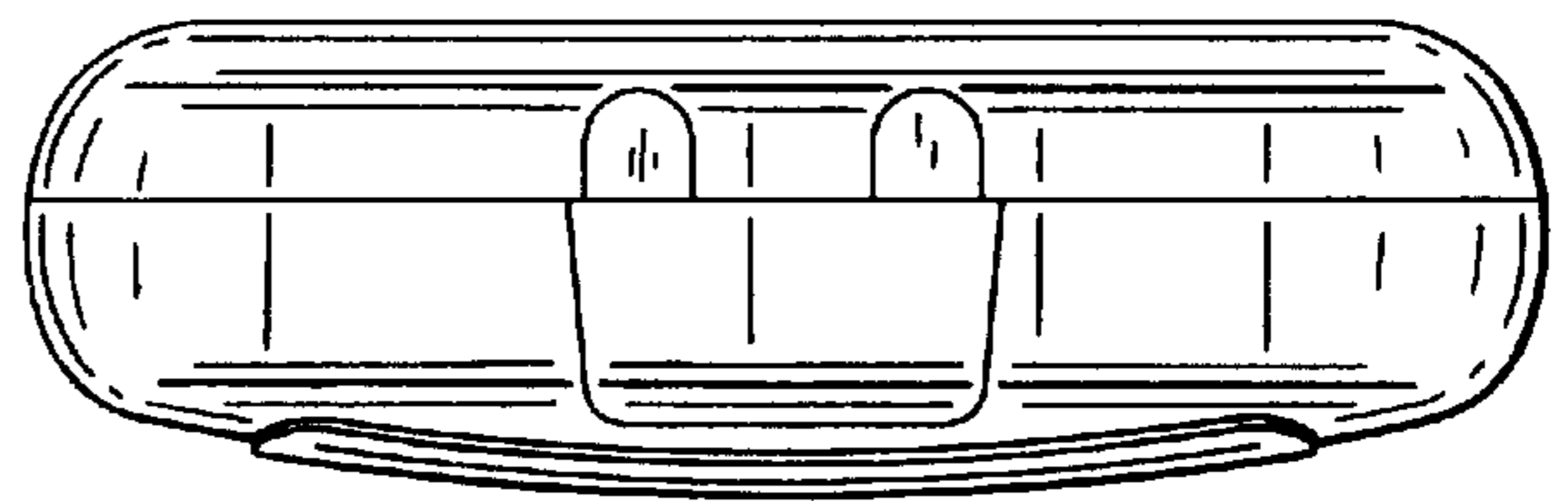

FIG. 10

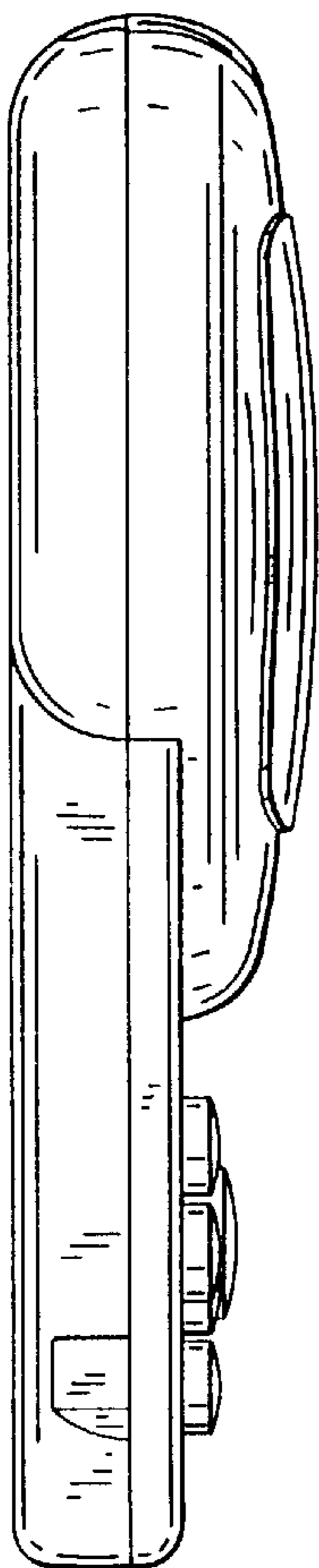

FIG. 11

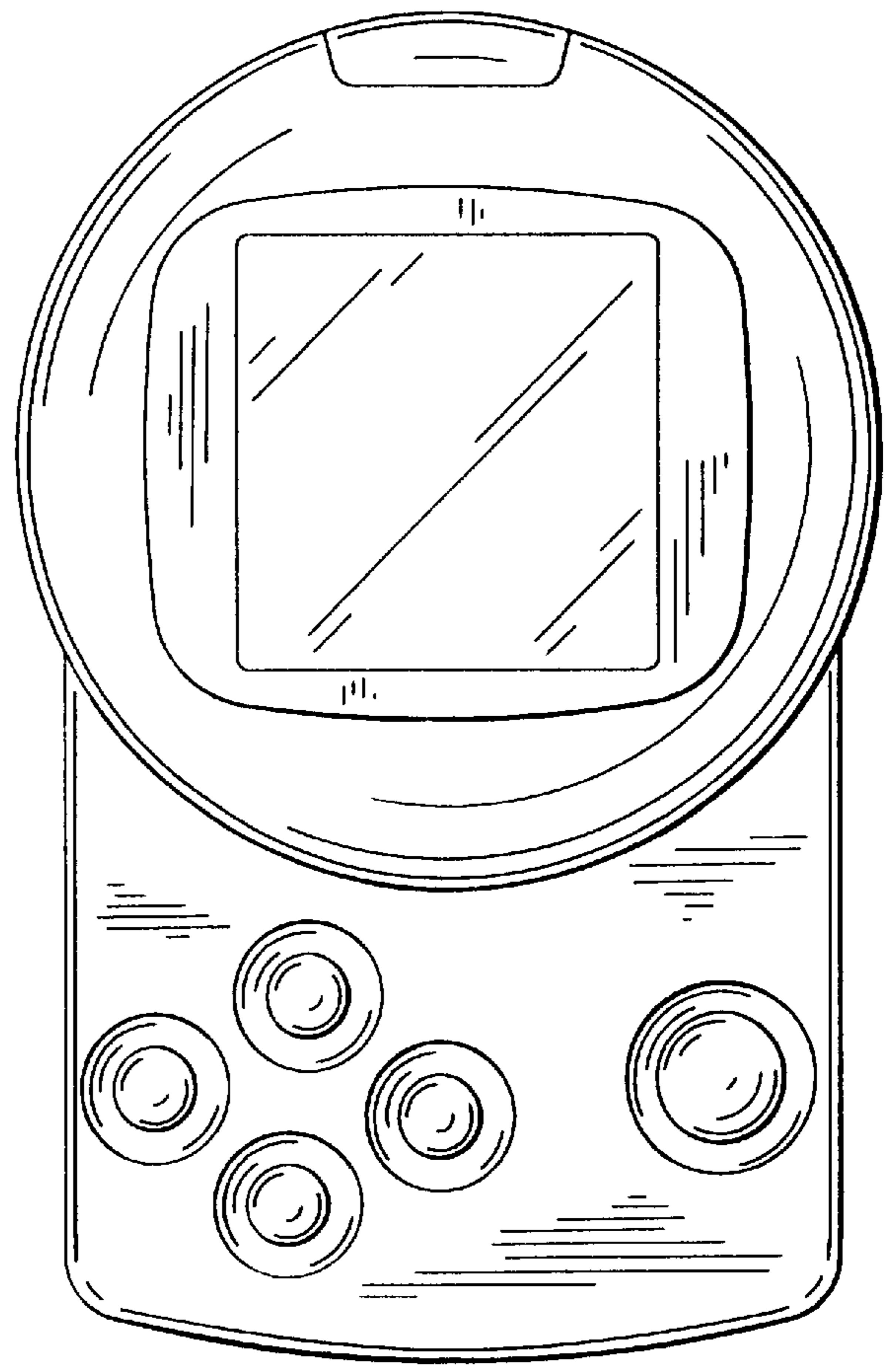

FIG. 13

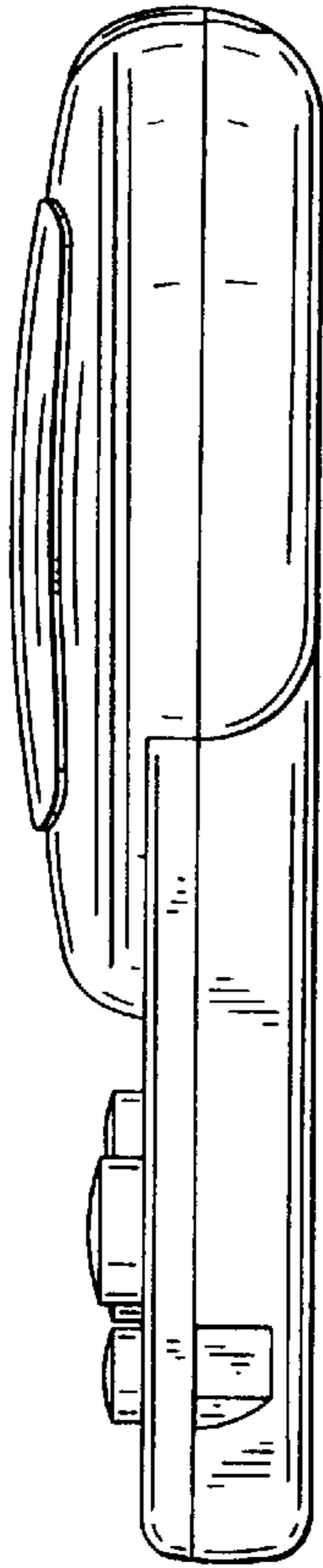

FIG. 14

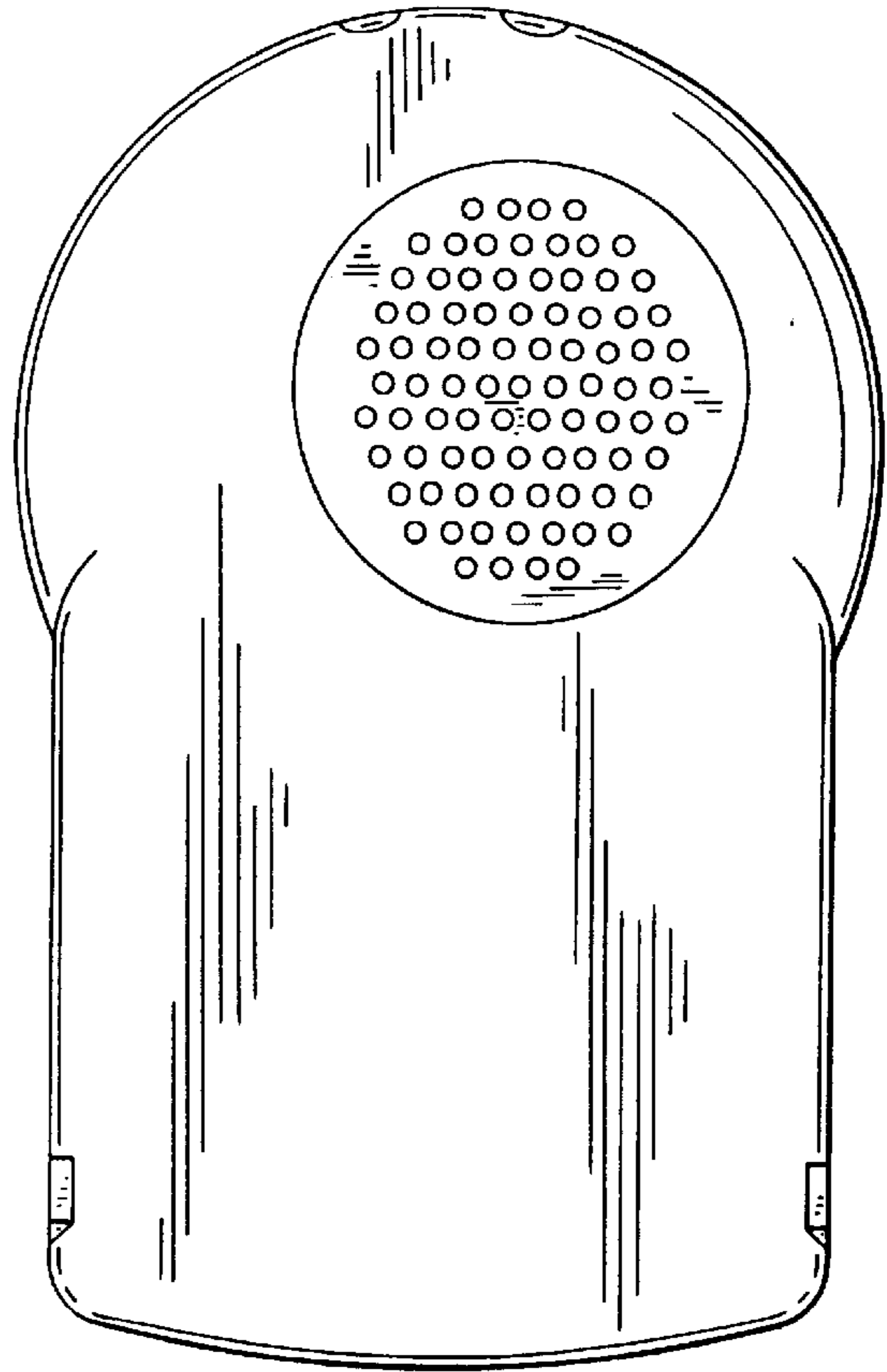

FIG. 12

