



US00D422024S

United States Patent [19]

[11] **Patent Number: Des. 422,024**

Andrews et al.

[45] **Date of Patent: ** Mar. 28, 2000**

[54] **WRITING INSTRUMENT**

DESCRIPTION

[75] Inventors: **Neville Andrews**, Acton, Mass.; **Philip Stankus**, Colwaltham, United Kingdom

FIG. 1 is a perspective view as seen from the top, front and right side of a first embodiment of a writing instrument showing our new design;

[73] Assignee: **Parker Pen Products**, Isleworth, United Kingdom

FIG. 2 is a top plan view thereof;

[**] Term: **14 Years**

FIG. 3 is a left side elevational view thereof, the right side elevation being a mirror image thereof;

[21] Appl. No.: **29/108,577**

FIG. 4 is a bottom plan view thereof;

[22] Filed: **Jul. 29, 1999**

FIG. 5 is a front elevational view thereof;

Related U.S. Application Data

FIG. 6 is a rear elevational view thereof;

[62] Division of application No. 29/093,935, Sep. 22, 1998.

FIG. 7 is a perspective view as seen from the top, front and right side of a second embodiment of a writing instrument showing our new design;

[51] **LOC (6) Cl.** **19-06**

FIG. 8 is a top plan view thereof;

[52] **U.S. Cl.** **D19/50; D19/43; D19/57**

FIG. 9 is a left side elevational view thereof, the right side elevation being a mirror image thereof;

[58] **Field of Search** D19/35, 36, 41-51, D19/53-58, 81-85; 401/99, 209, 221, 243, 244, 245, 246, 247, 202, 262

FIG. 10 is a bottom plan view thereof;

FIG. 11 is a front elevational view thereof;

[56] **References Cited**

FIG. 12 is a rear elevational view thereof;

U.S. PATENT DOCUMENTS

D. 031,670	10/1899	Oberbeck	D19/50
D. 138,032	6/1944	Severy	D19/43
D. 362,269	9/1995	Hollington	D19/51
D. 372,048	7/1996	Hollington	D19/43
D. 380,046	6/1997	Domanowski	D19/55 X
D. 404,764	1/1999	Perry et al.	D19/48

FIG. 13 is a perspective view as seen from the top, front and right side of the writing instrument of FIG. 1 or 7 with a cap over the writing end of the writing instrument showing our new design;

FIG. 14 is a top plan view thereof;

FIG. 15 is a left side elevational view thereof, the right side elevation being a mirror image thereof;

Primary Examiner—Martie K. Holtje
Attorney, Agent, or Firm—David A. Howley

FIG. 16 is a bottom plan view thereof;

FIG. 17 is a front elevational view thereof; and,

FIG. 18 is a rear elevational view thereof.

[57] **CLAIM**

The ornamental design for a writing instrument, as shown and described.

1 Claim, 9 Drawing Sheets

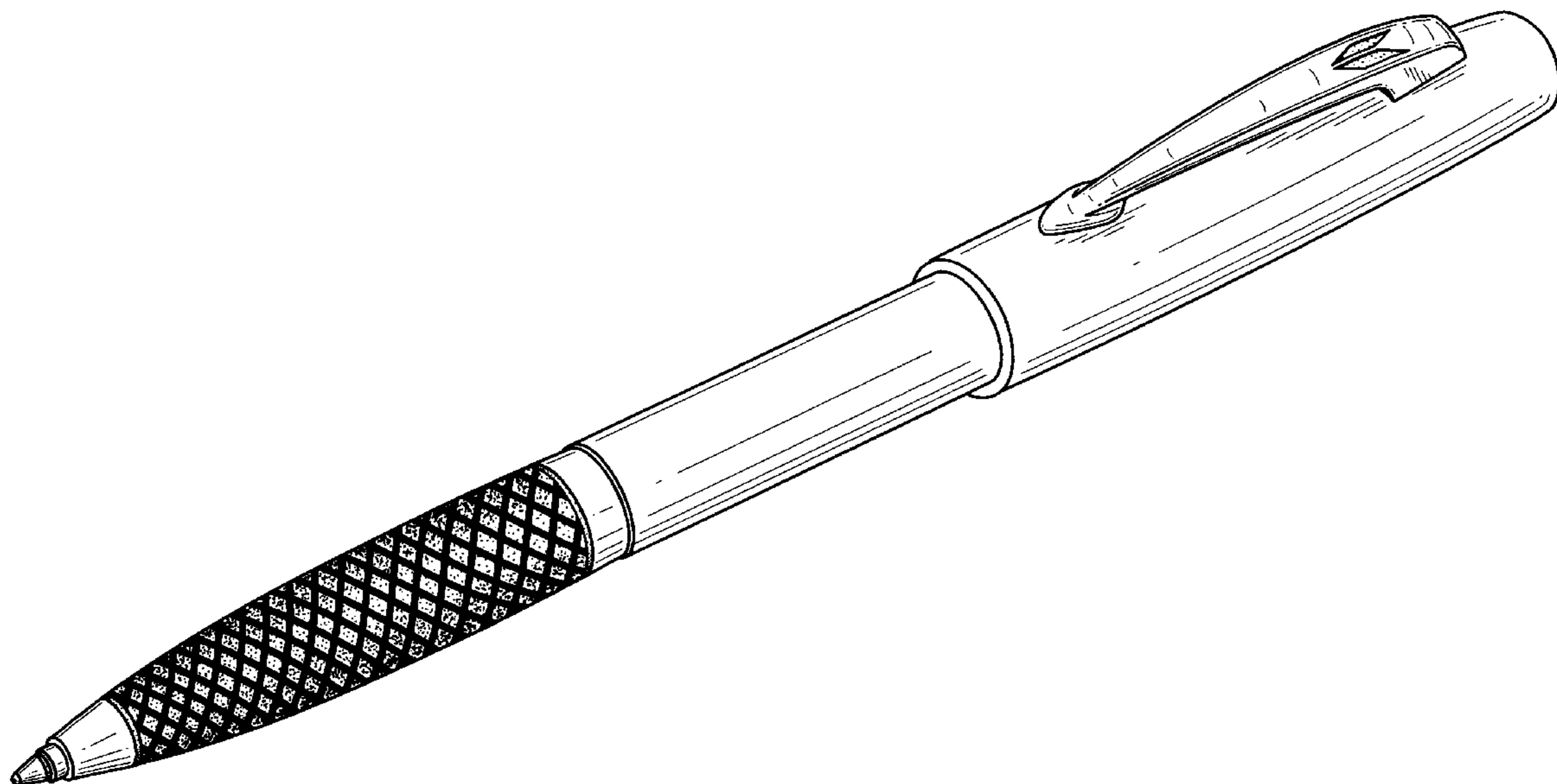

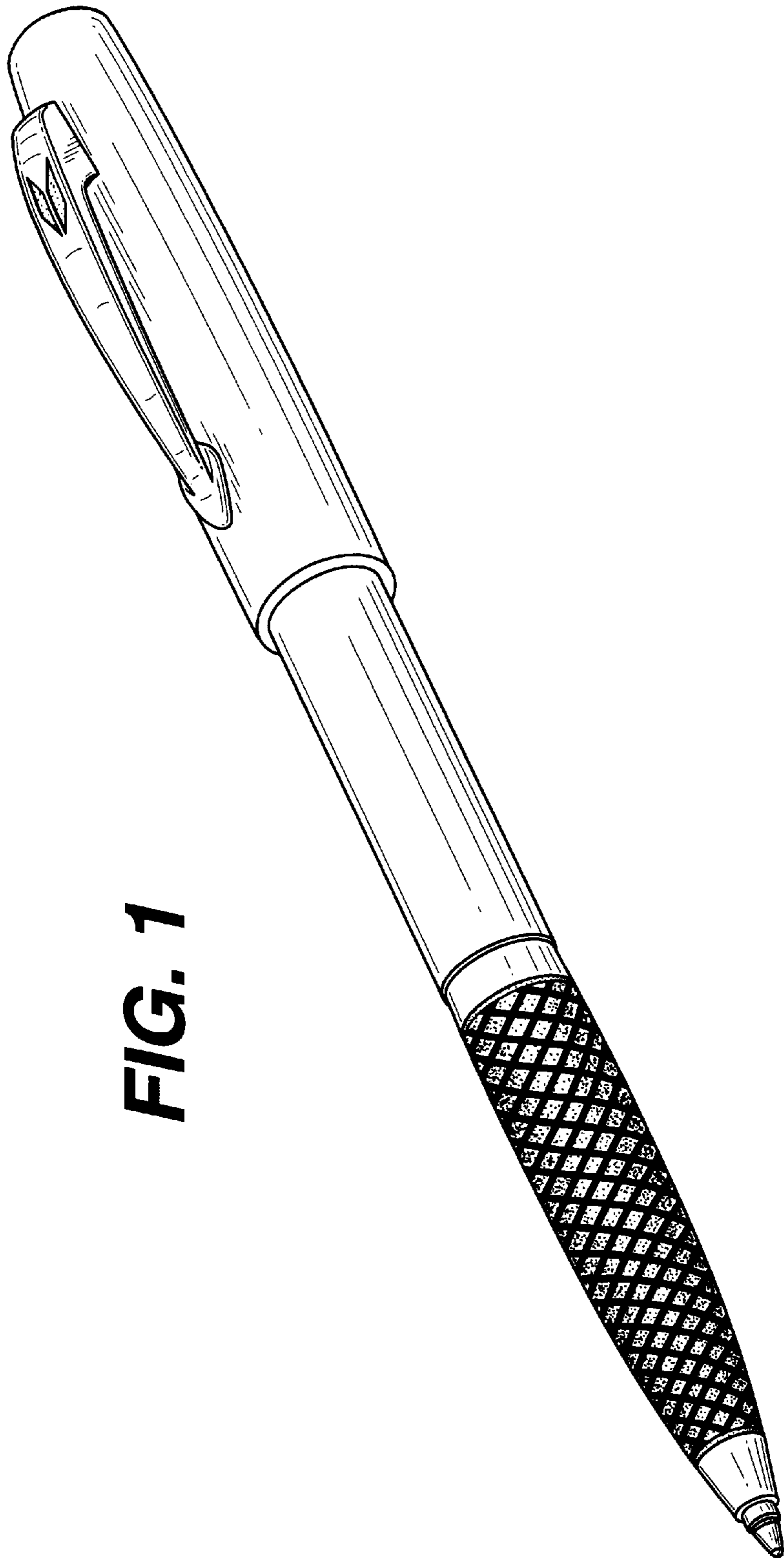

FIG. 1

FIG. 2

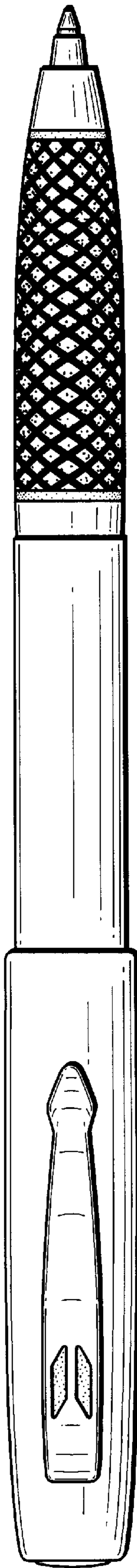

FIG. 3

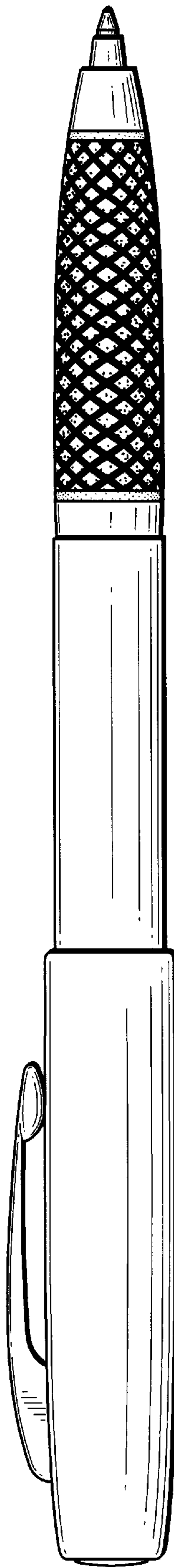

FIG. 4

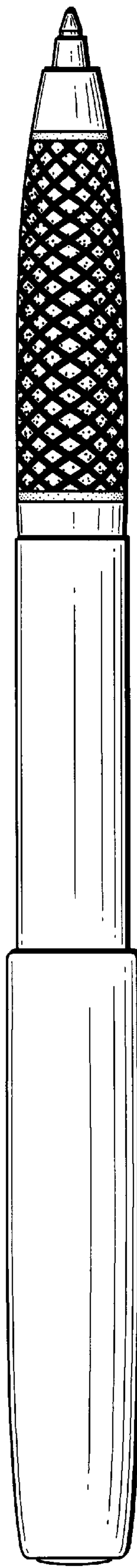

FIG. 5

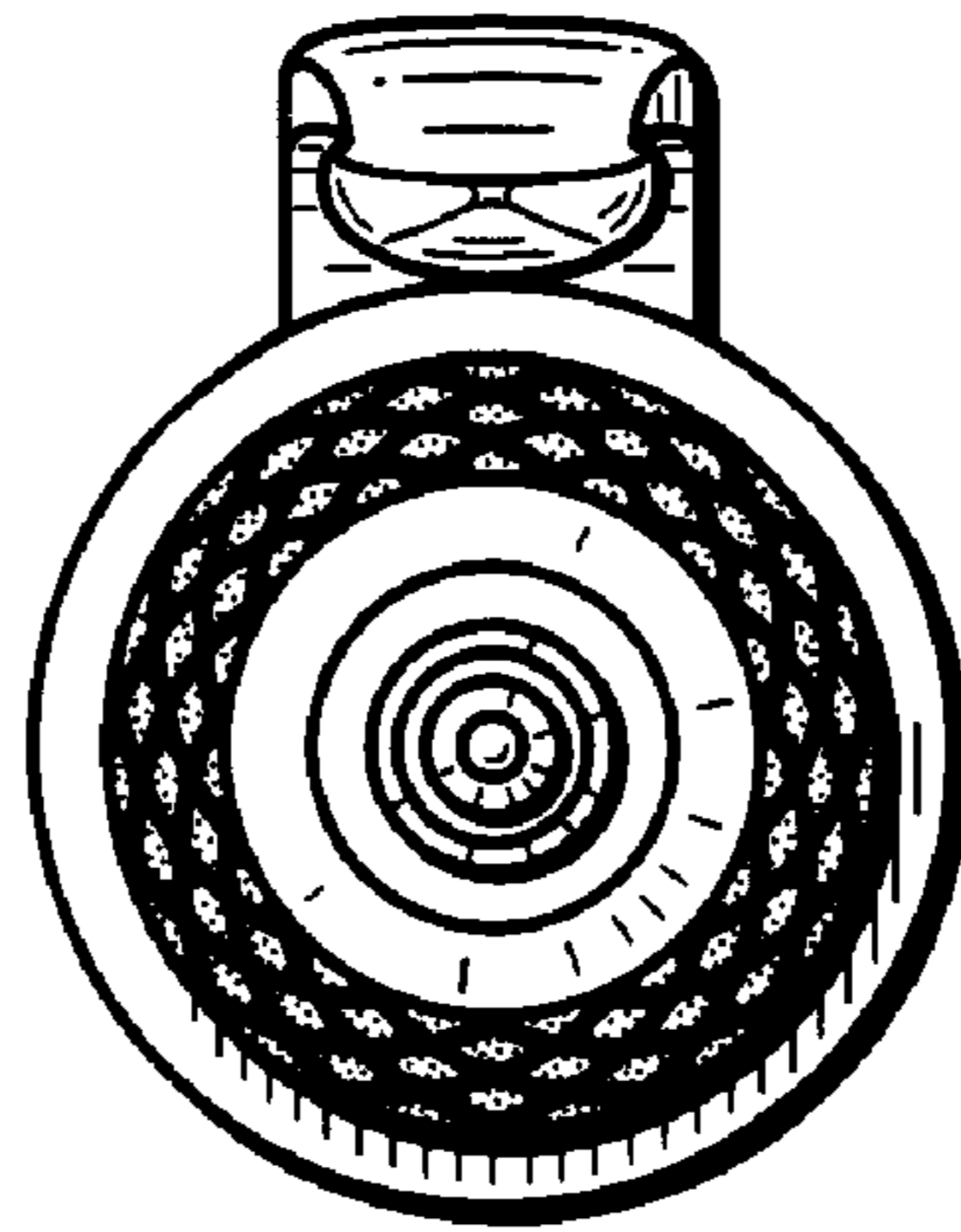
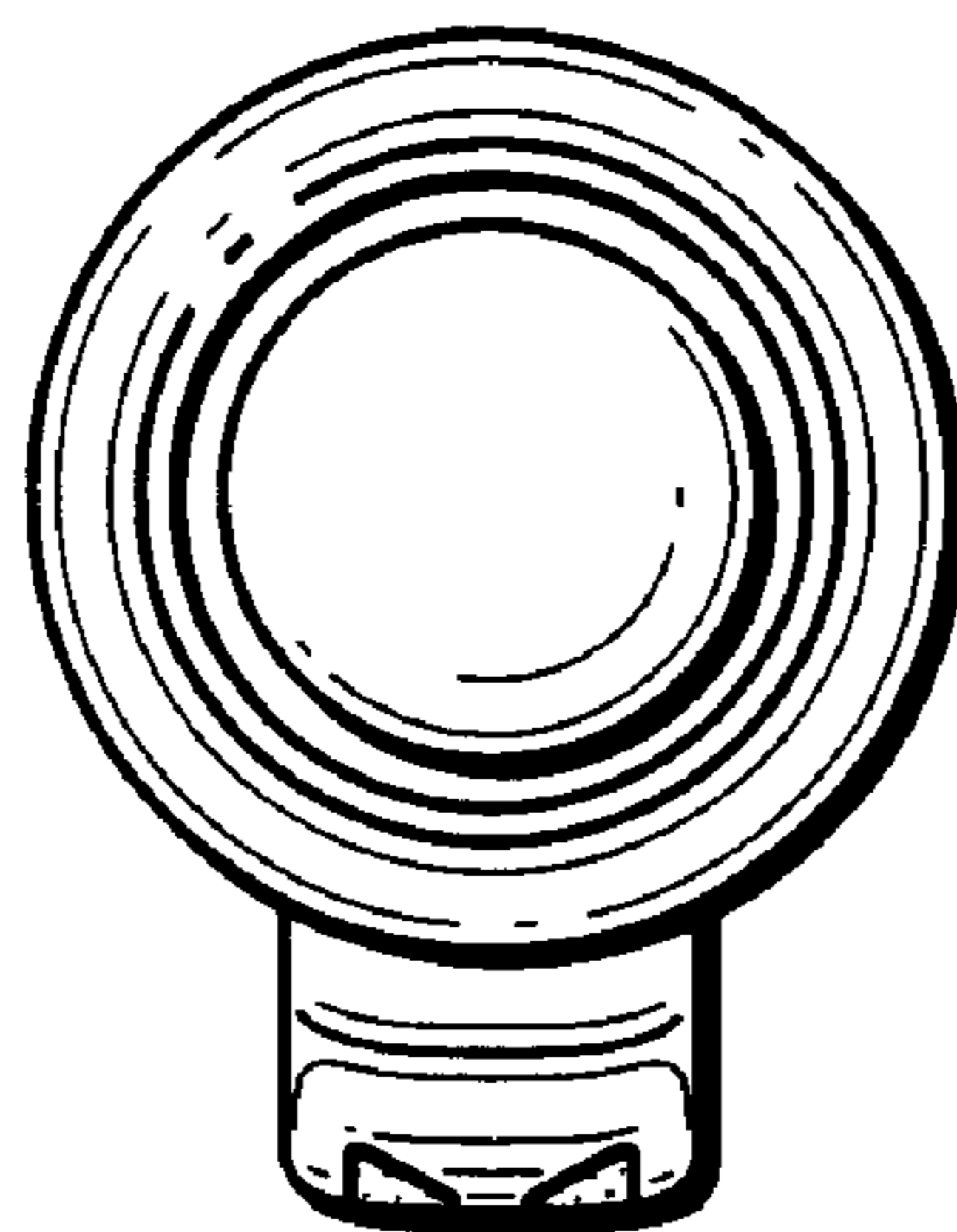

FIG. 6



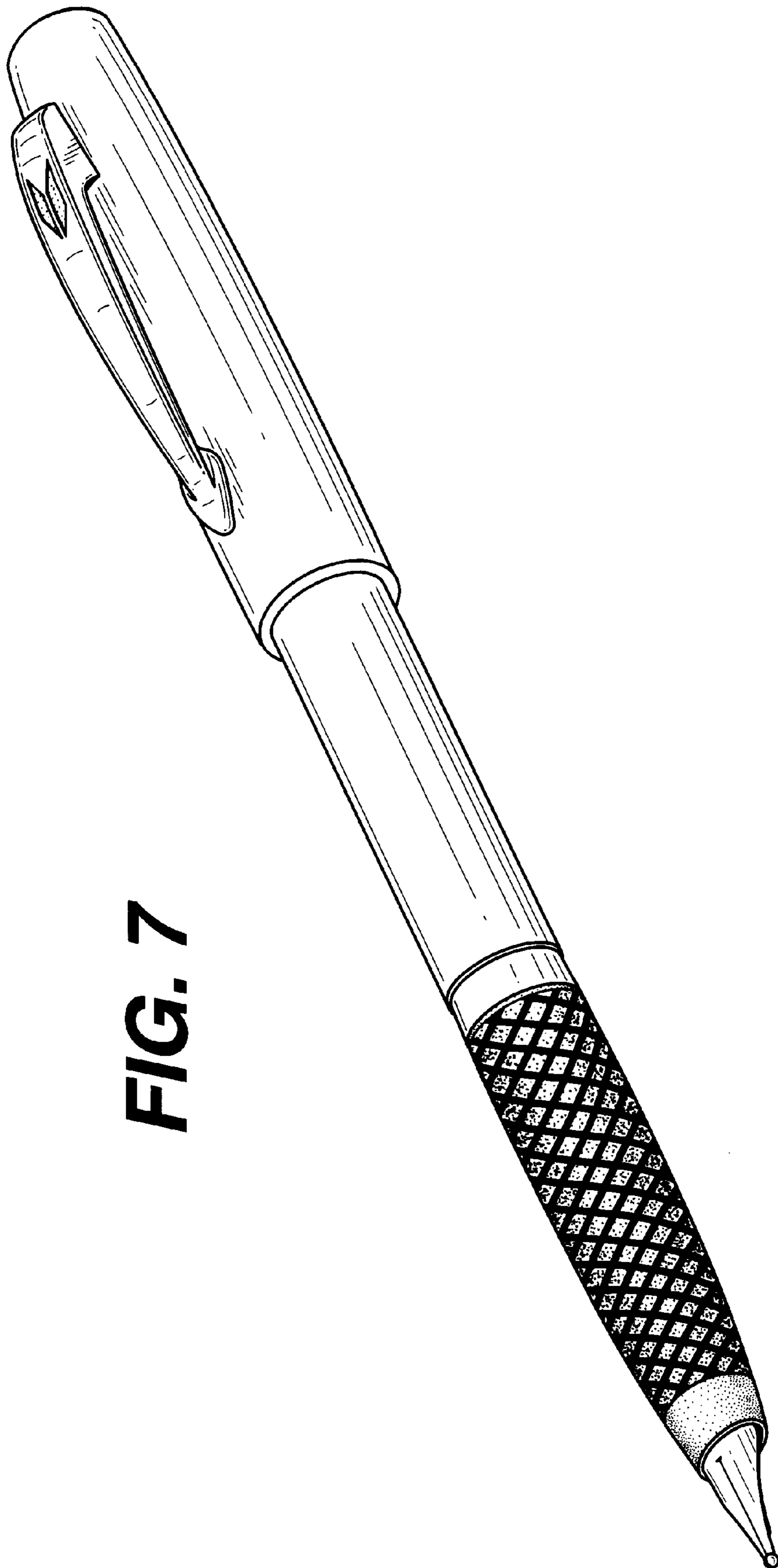

FIG. 7

FIG. 8

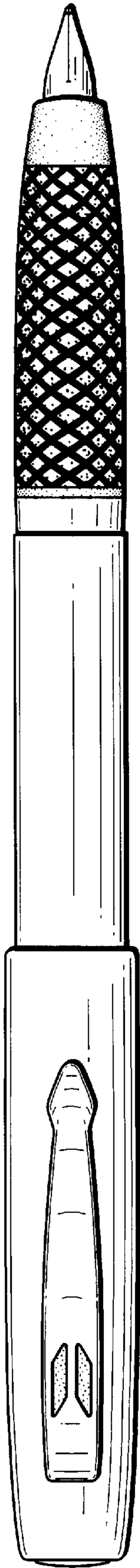

FIG. 9

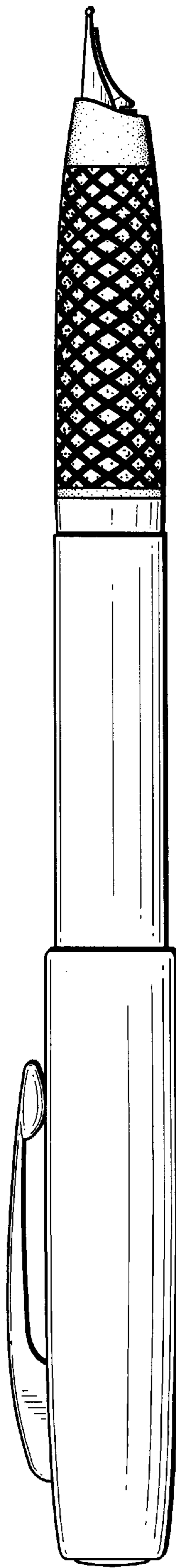

FIG. 10

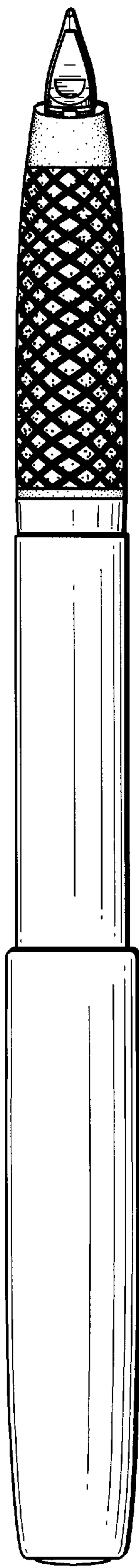

FIG. 11

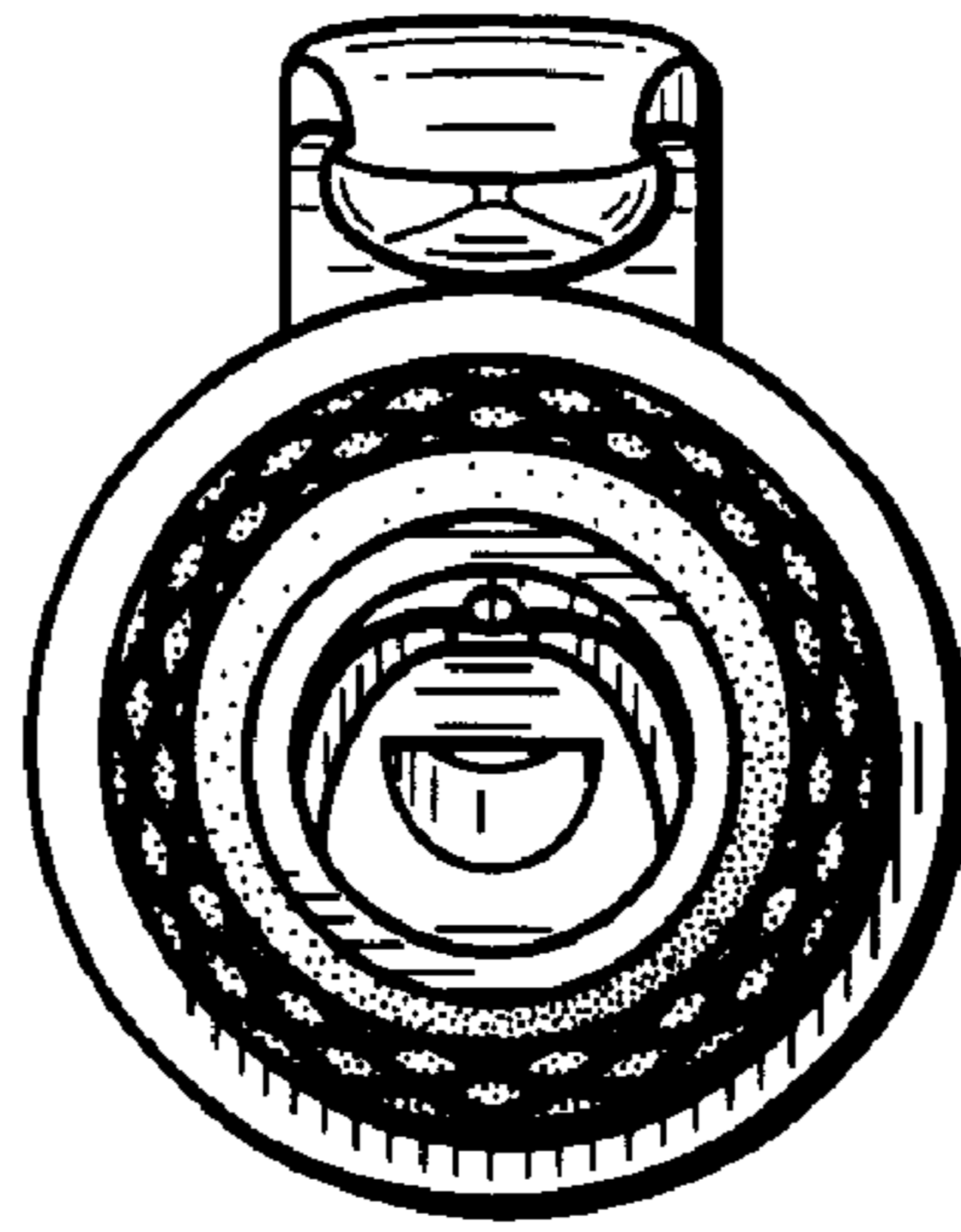
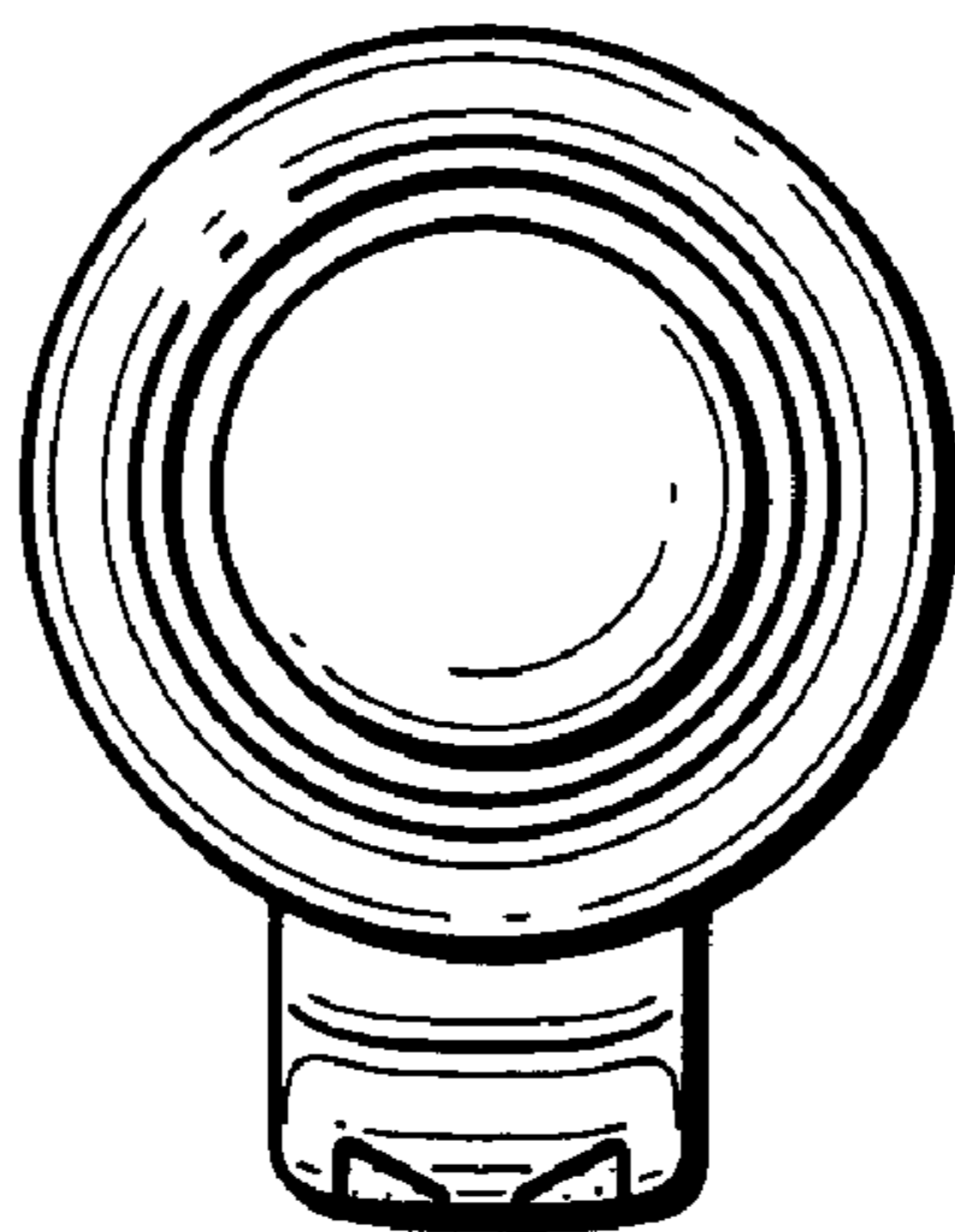

FIG. 12



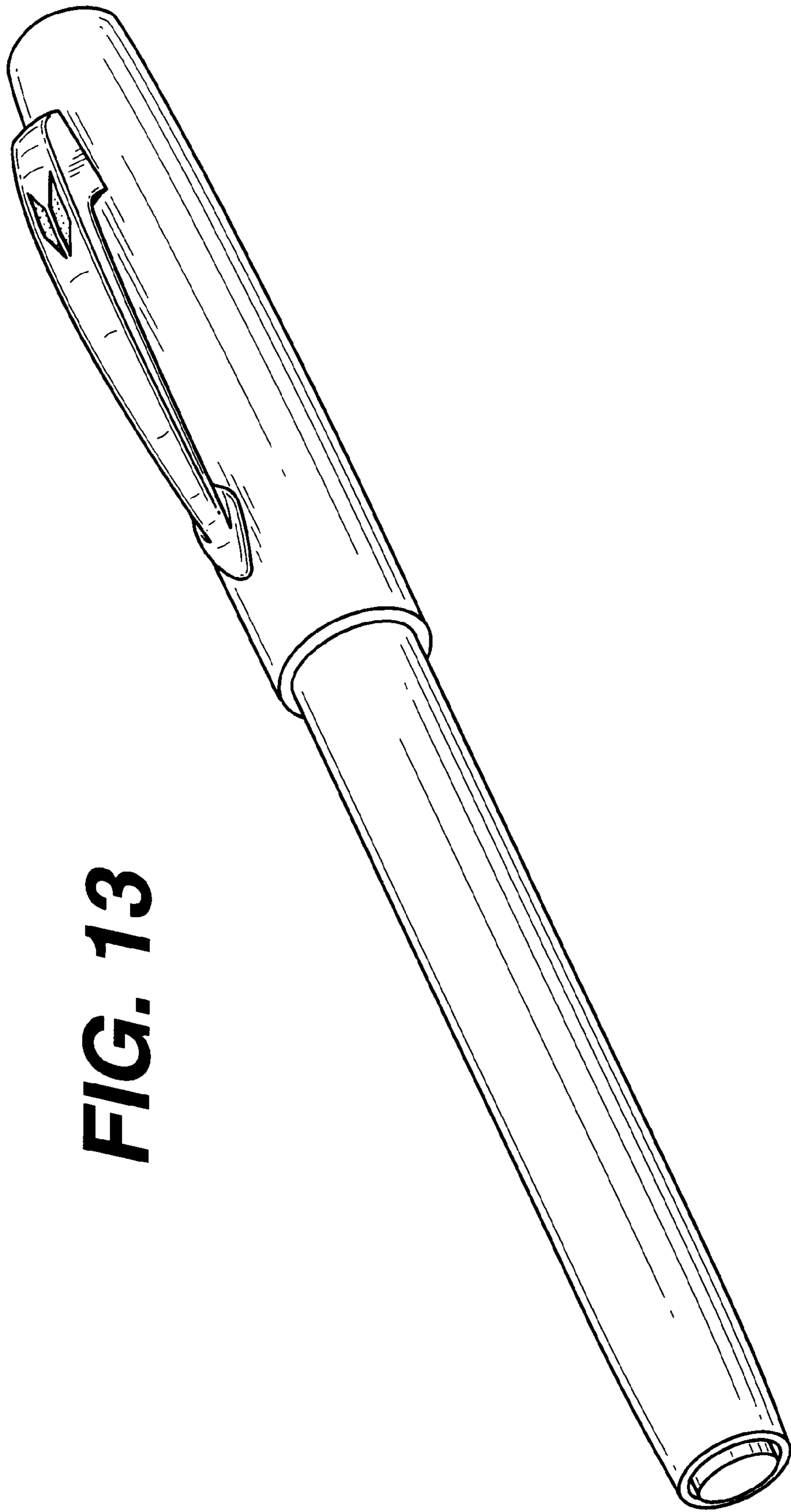

FIG. 13

FIG. 14

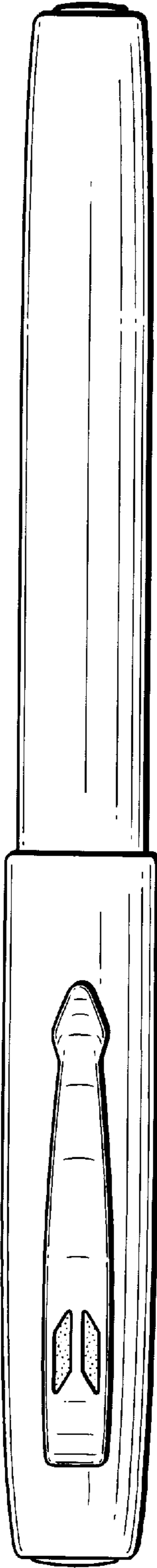

FIG. 15

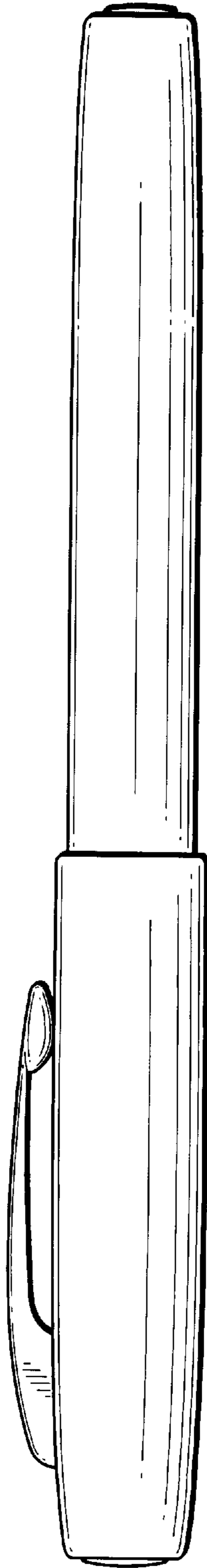

FIG. 16

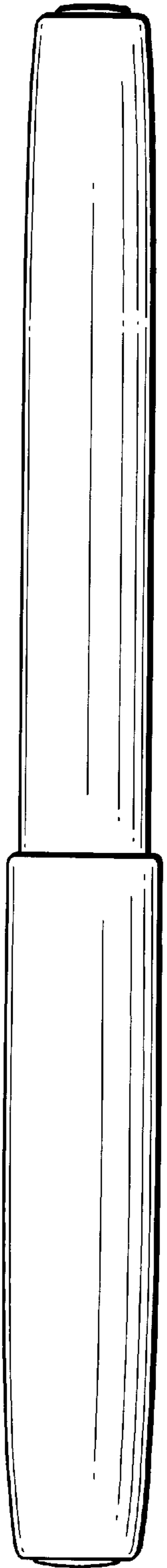

FIG. 17

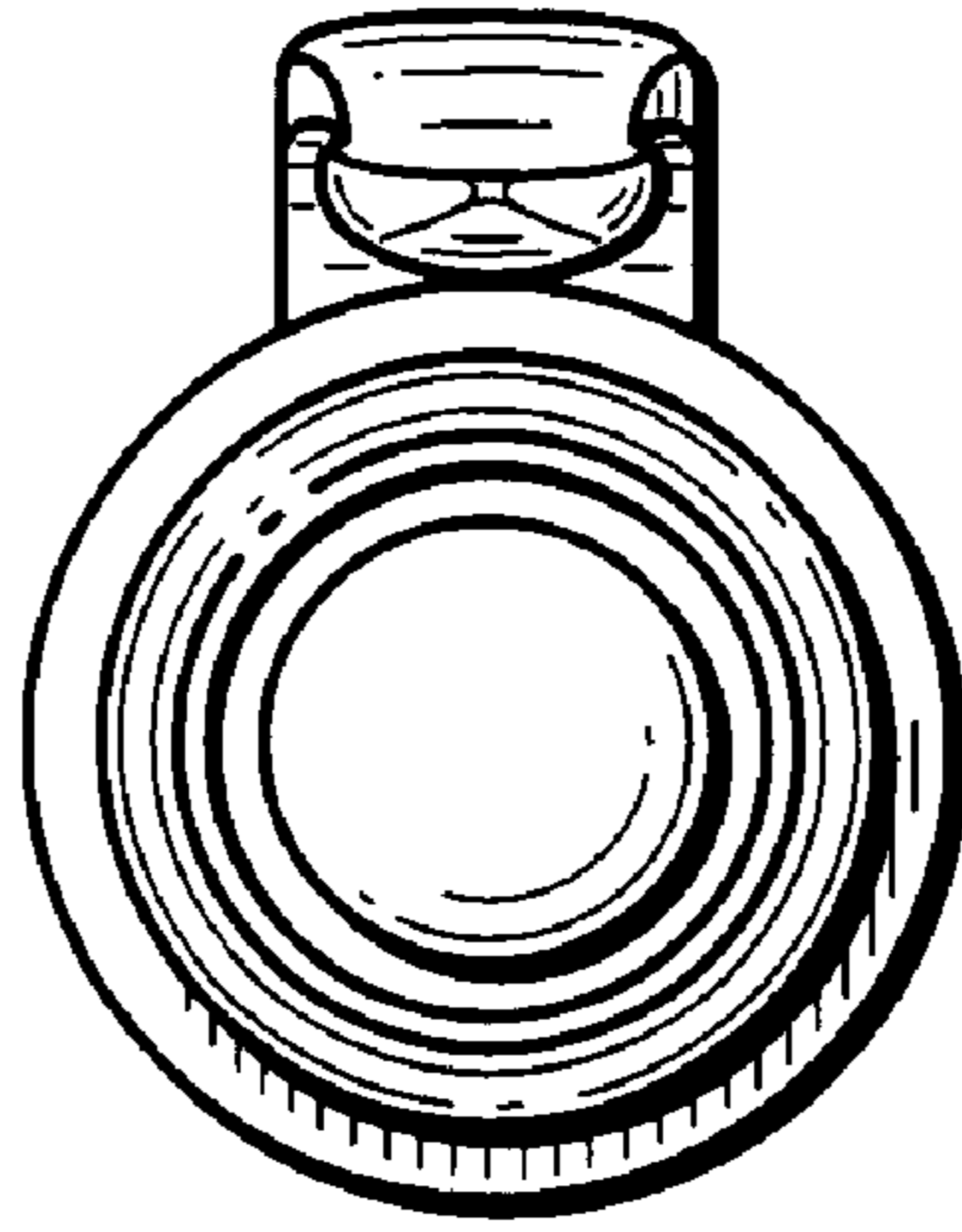

FIG. 18

