



US00D421991S

**United States Patent** [19]  
**Matsuoka**

[11] **Patent Number: Des. 421,991**  
[45] **Date of Patent: \*\* Mar. 28, 2000**

- [54] **SPEAKER BOX**
- [75] Inventor: **Yoshimichi Matsuoka**, Tokyo, Japan
- [73] Assignee: **Sony Corporation**, Tokyo, Japan
- [\*\*] Term: **14 Years**
- [21] Appl. No.: **29/093,843**
- [22] Filed: **Sep. 18, 1998**
- [51] **LOC (6) Cl.** ..... **14-01**
- [52] **U.S. Cl.** ..... **D14/214; D14/215**
- [58] **Field of Search** ..... **D14/204, 210-216;**  
181/144-145, 147-148, 153, 157, 198,  
199; 381/24, 88, 90, 91, 153, 159, 186,  
188

[56] **References Cited**

**U.S. PATENT DOCUMENTS**

D. 268,673	4/1983	Iijima	.....	D14/214
D. 370,679	6/1996	Olson	.....	D14/211 X
D. 377,175	1/1997	Boyd	.....	D14/214
D. 384,668	10/1997	Yoneda	.....	D14/214
5,216,211	6/1993	Renk, Jr.	.....	181/153

**OTHER PUBLICATIONS**

Catalog "86", pp. 121, 123 & 338, Sony (Jul. 1997).  
Catalog "87", p. 346, Sony (Nov. 1997).  
Catalog "89", p. 332 (Jul. 1998).

*Primary Examiner*—Nanda Bondade

*Attorney, Agent, or Firm*—Foley & Lardner

[57] **CLAIM**

The ornamental design for a speaker box, as shown and described.

**DESCRIPTION**

FIG. 1 is a perspective view of a first embodiment of a speaker box showing my new design;  
 FIG. 2 is a top plan view thereof;  
 FIG. 3 is a bottom plan view thereof;  
 FIG. 4 is a left side elevational view thereof;  
 FIG. 5 is a right side elevational view thereof;  
 FIG. 6 is a front elevational view thereof;  
 FIG. 7 is a rear elevational view thereof;  
 FIG. 8 is a perspective view of a second embodiment of FIG. 1; the remaining views of the second embodiment being mirror images of the first embodiment;  
 FIG. 9 is a perspective view of a third embodiment of FIG. 1;  
 FIG. 10 is a top plan view thereof;  
 FIG. 11 is a bottom plan view thereof;  
 FIG. 12 is a left side elevational view thereof;  
 FIG. 13 is a right side elevational view thereof;  
 FIG. 14 is a front elevational view thereof;  
 FIG. 15 is a rear elevational view thereof; and,  
 FIG. 16 is a perspective view of a fourth embodiment of FIG. 1; the remaining views of the fourth embodiment being mirror images of the third embodiment.

**1 Claim, 10 Drawing Sheets**

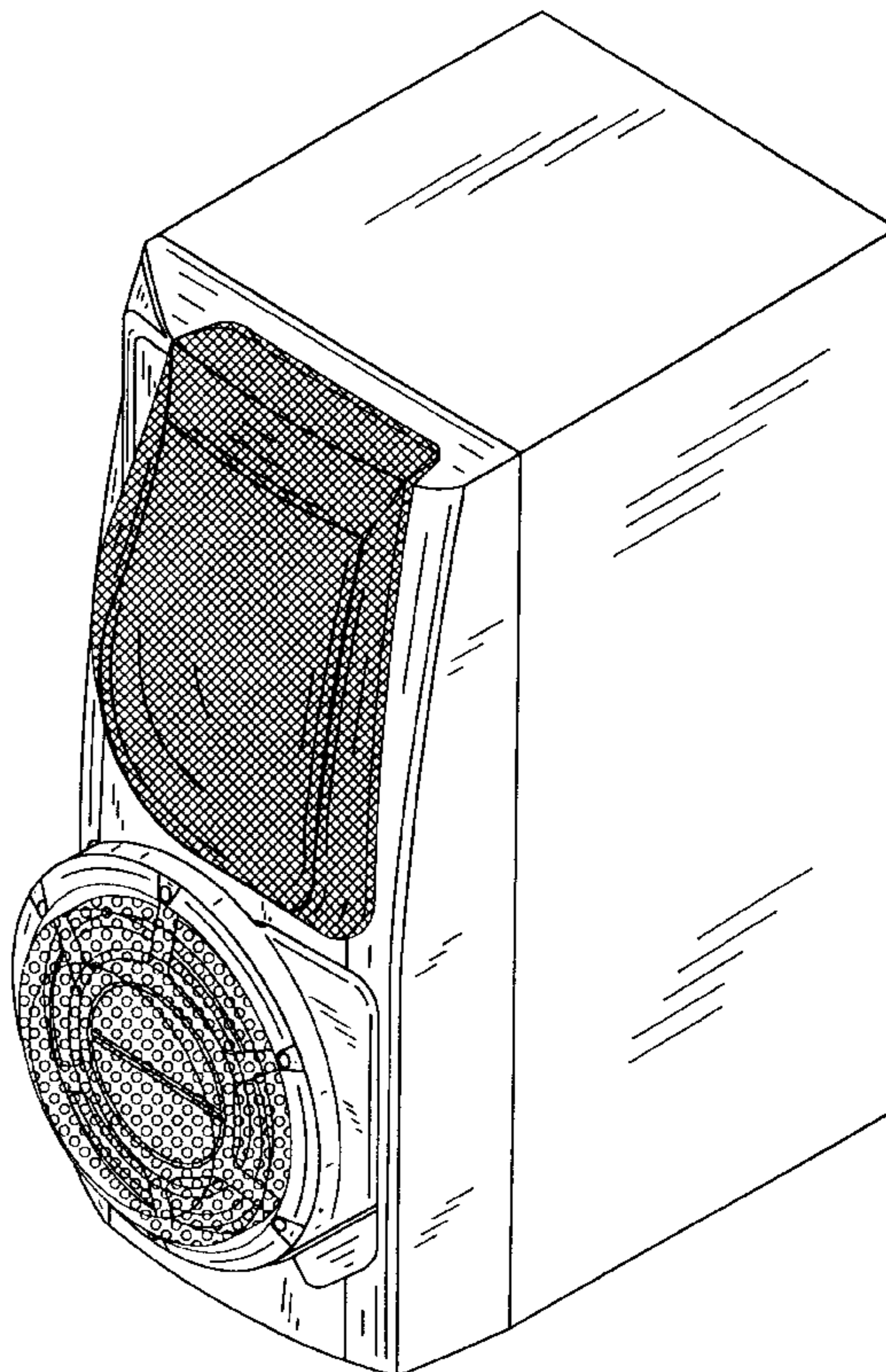
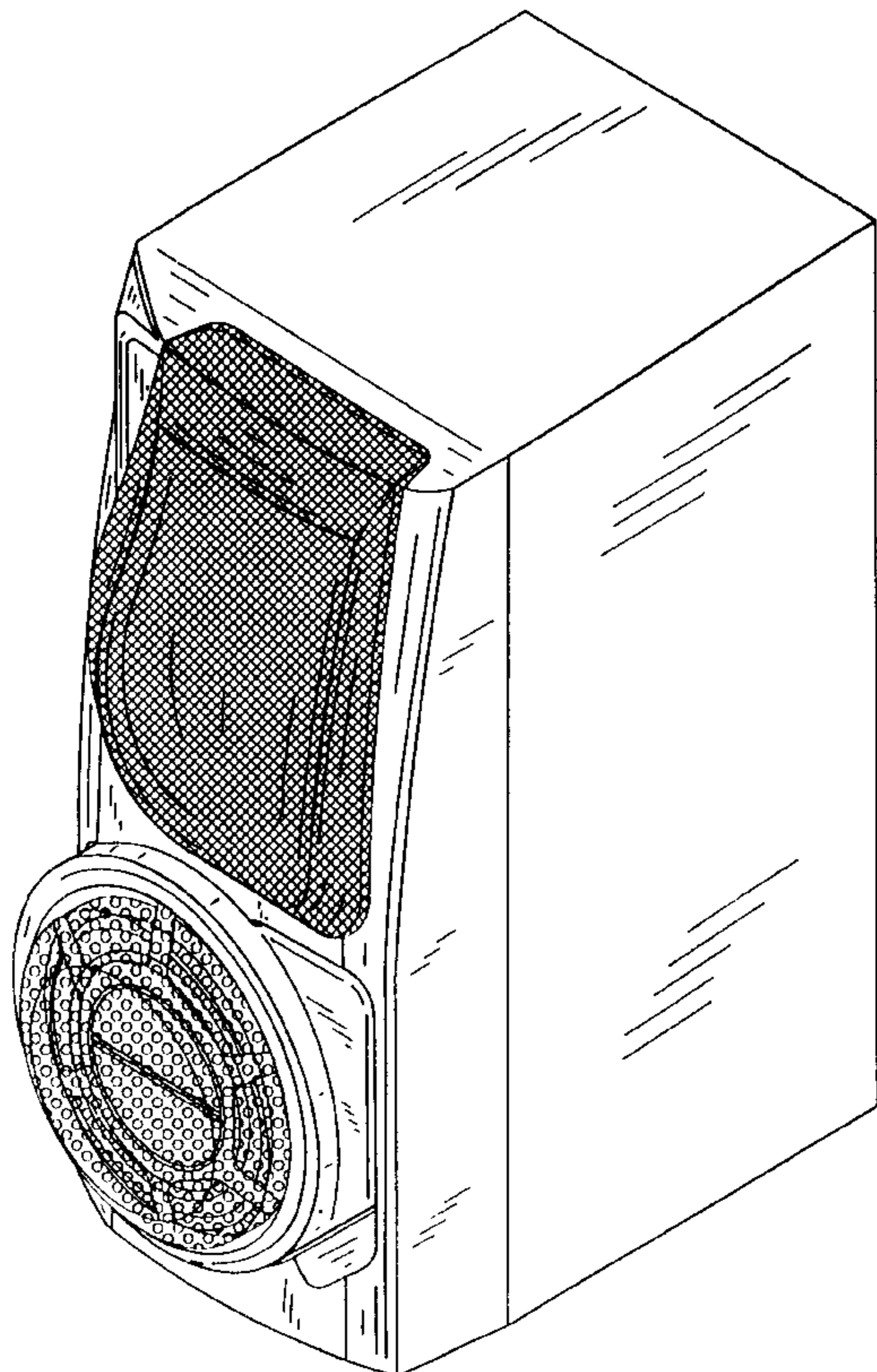

FIG. 1

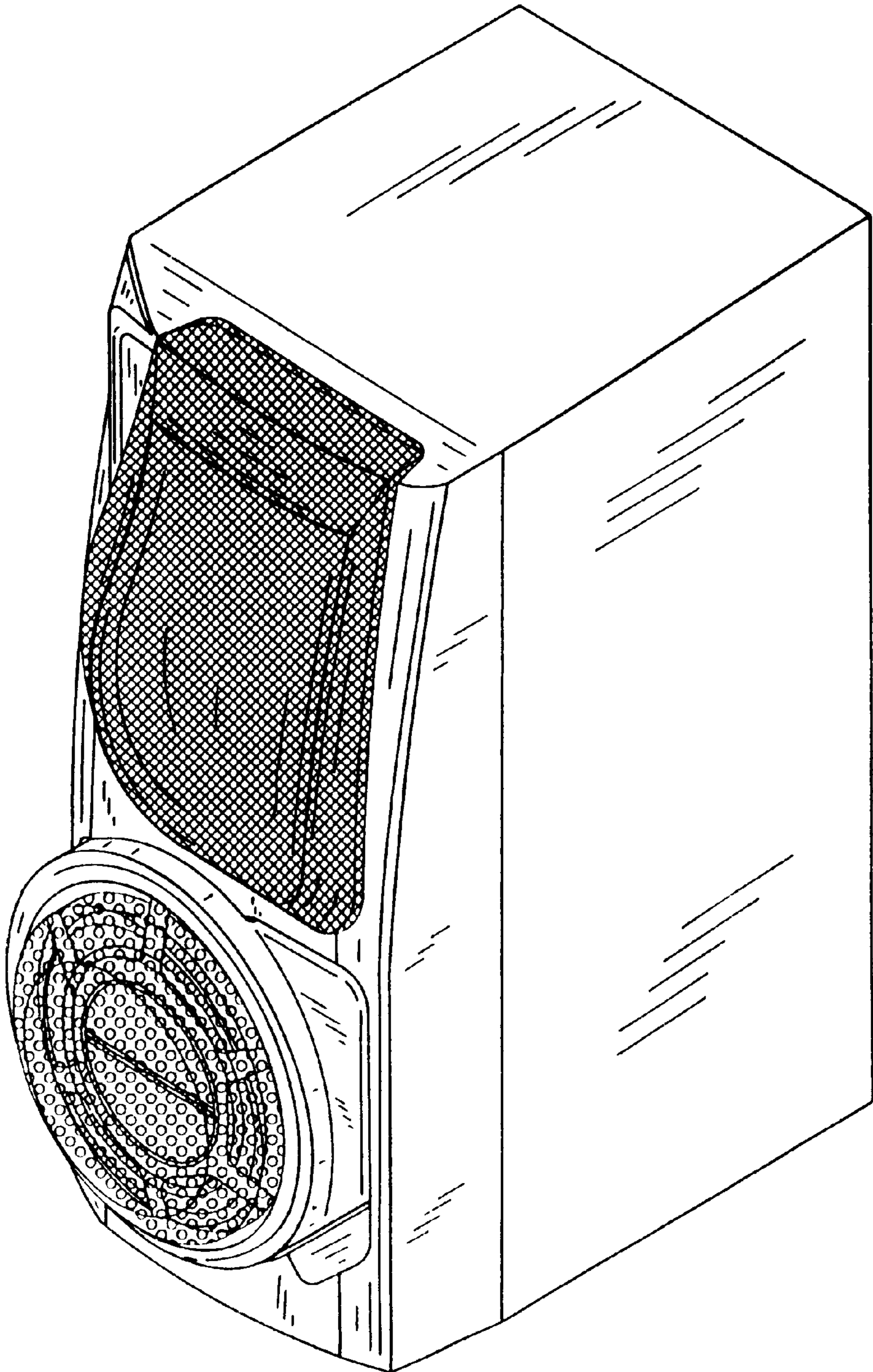

FIG. 2

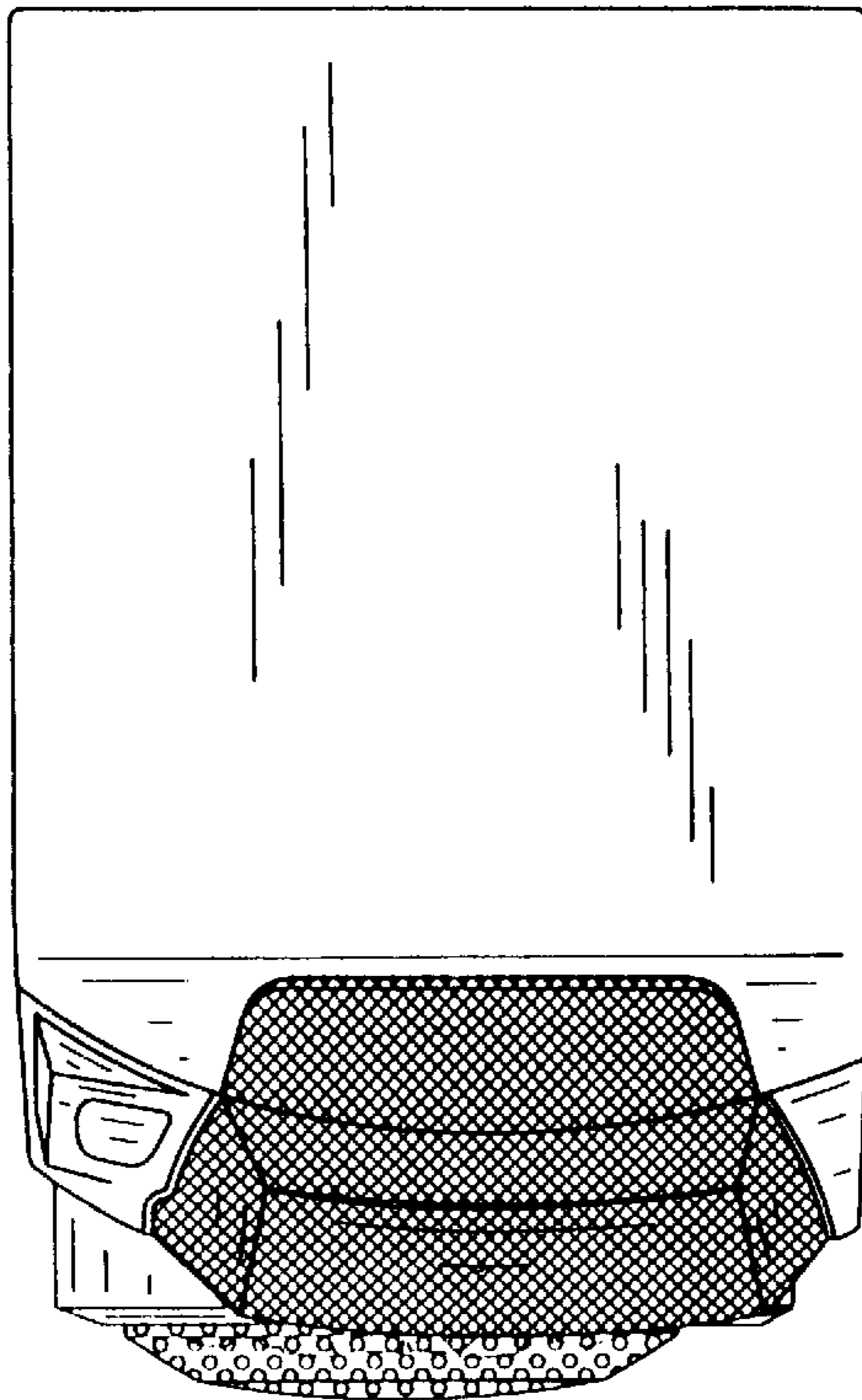

FIG. 3

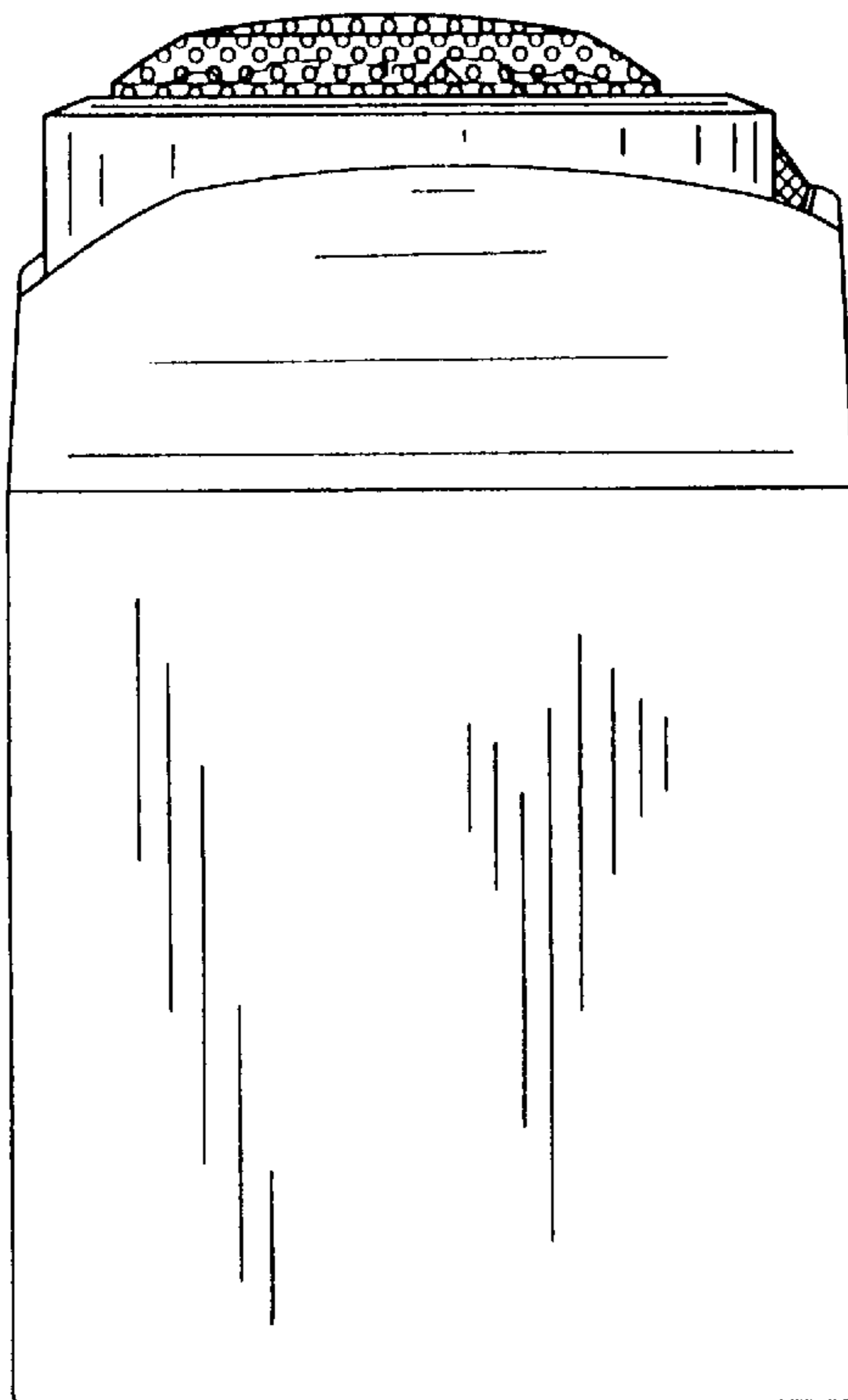

FIG. 5

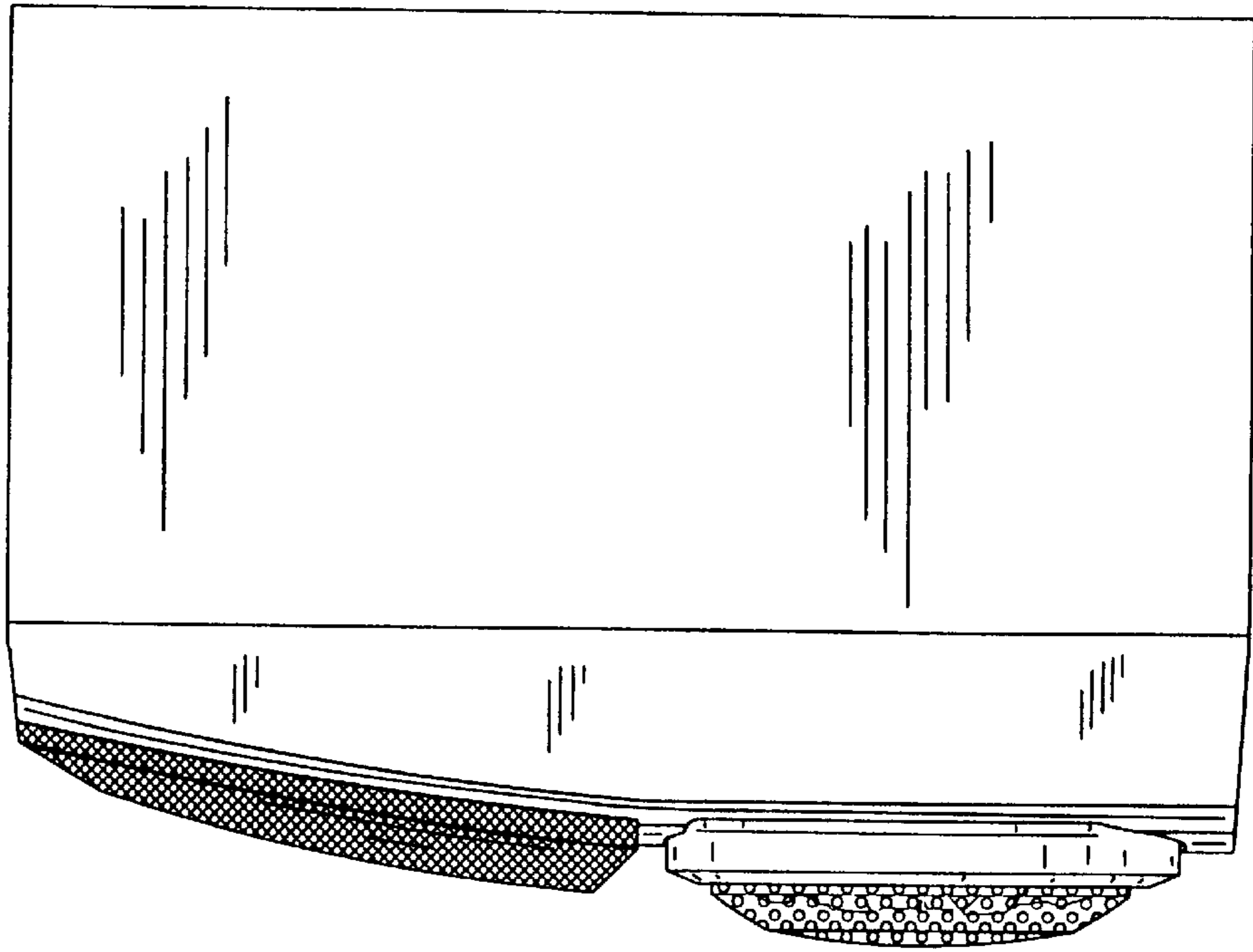

FIG. 4

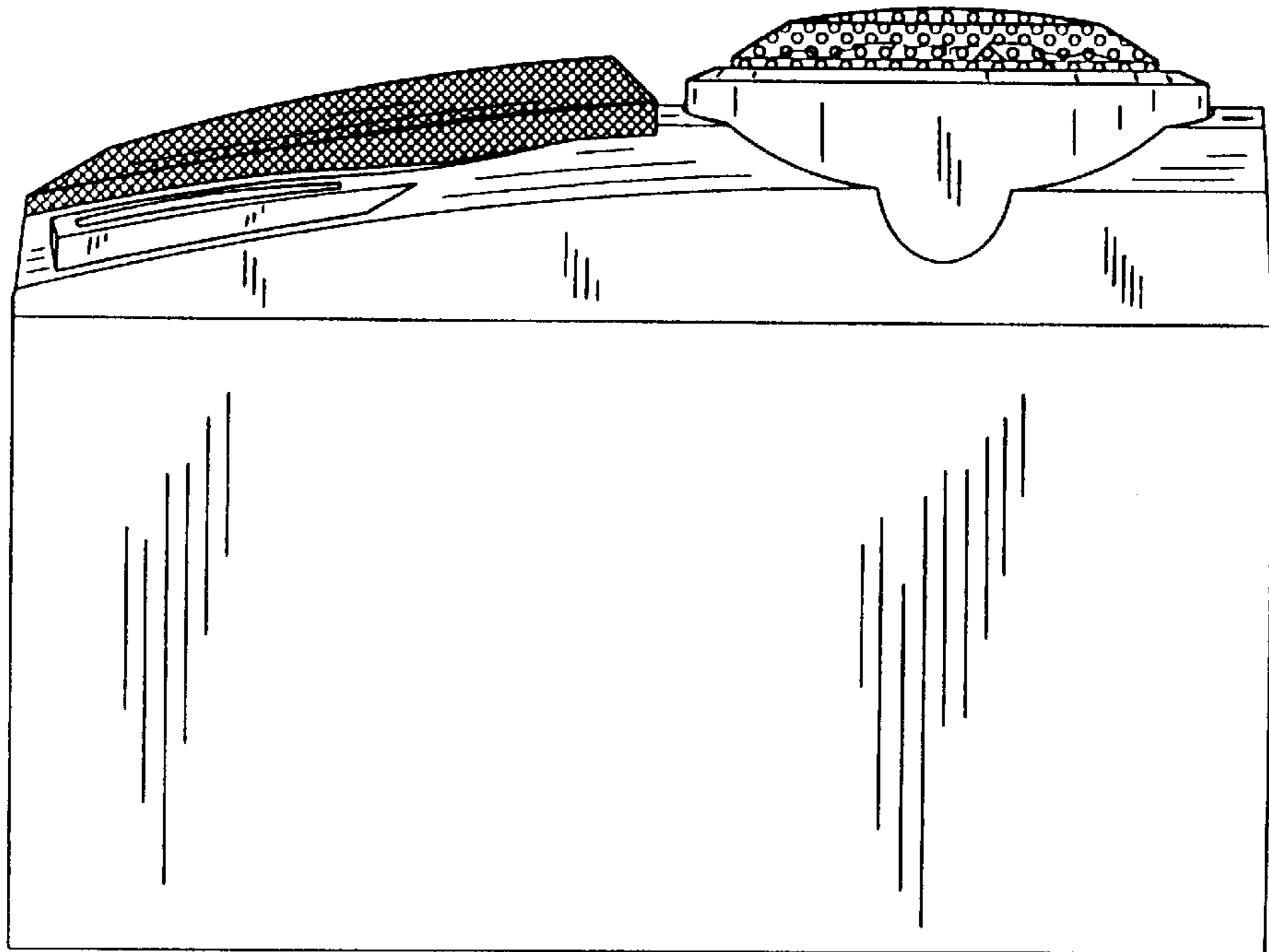

FIG. 7

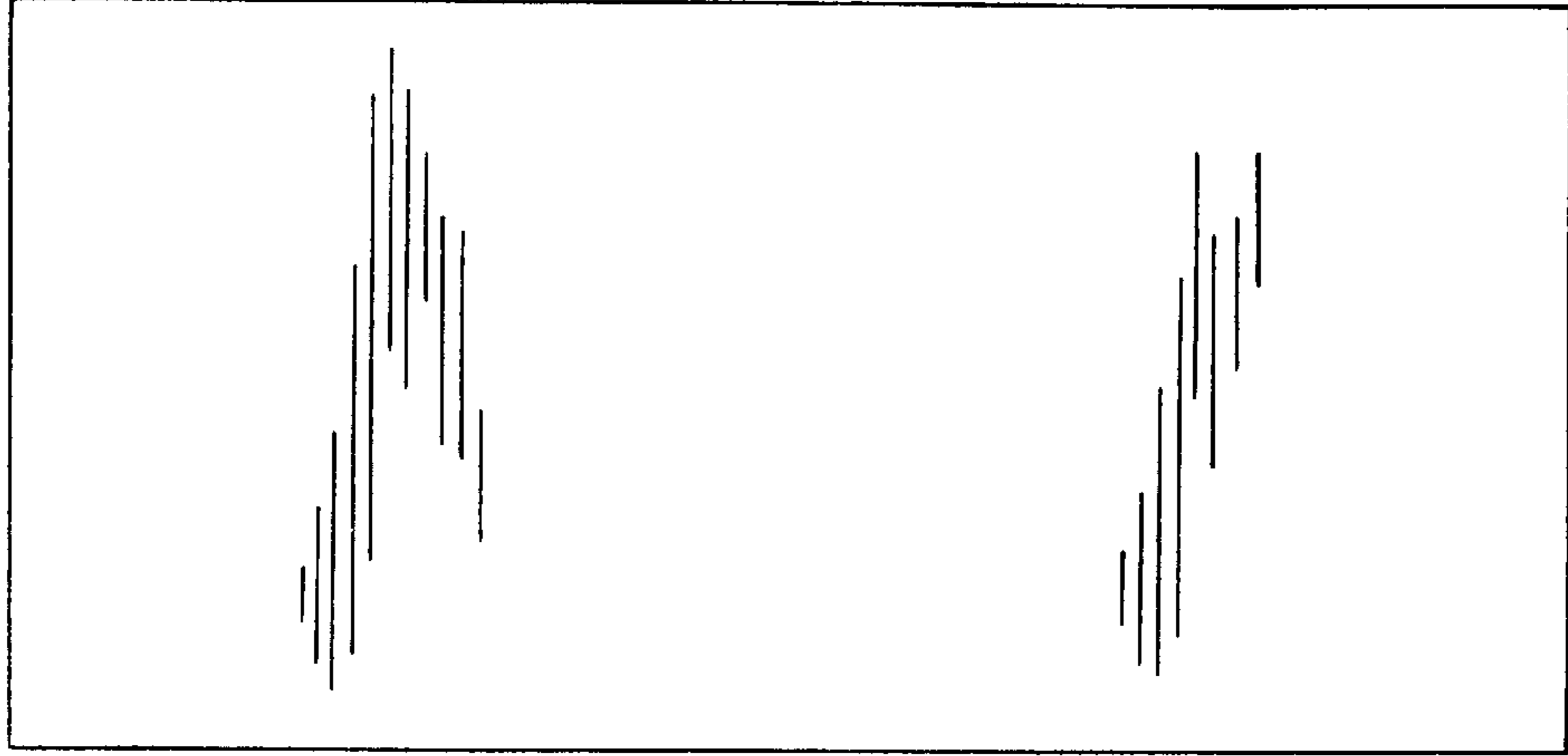

FIG. 6

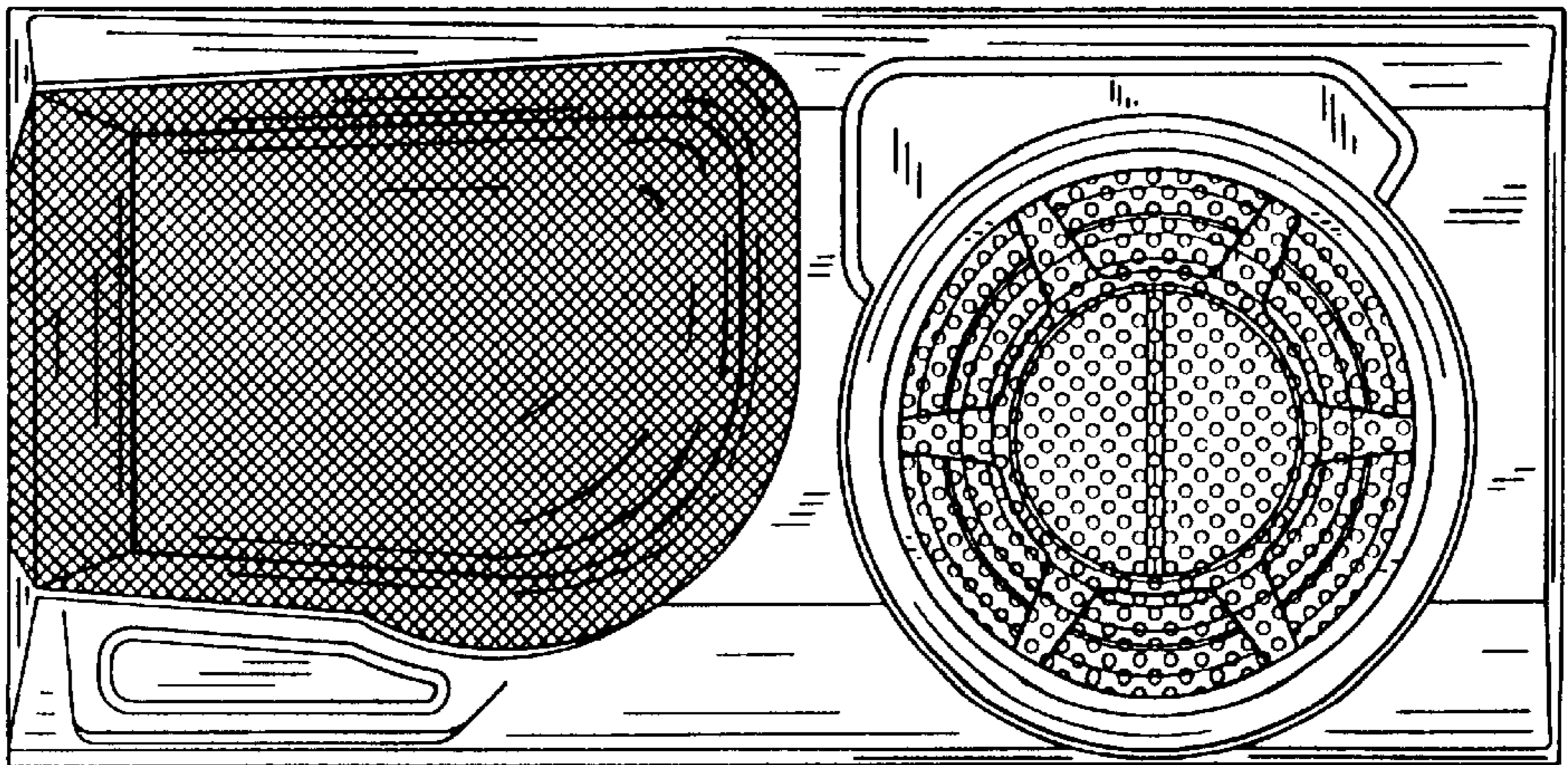

FIG. 8

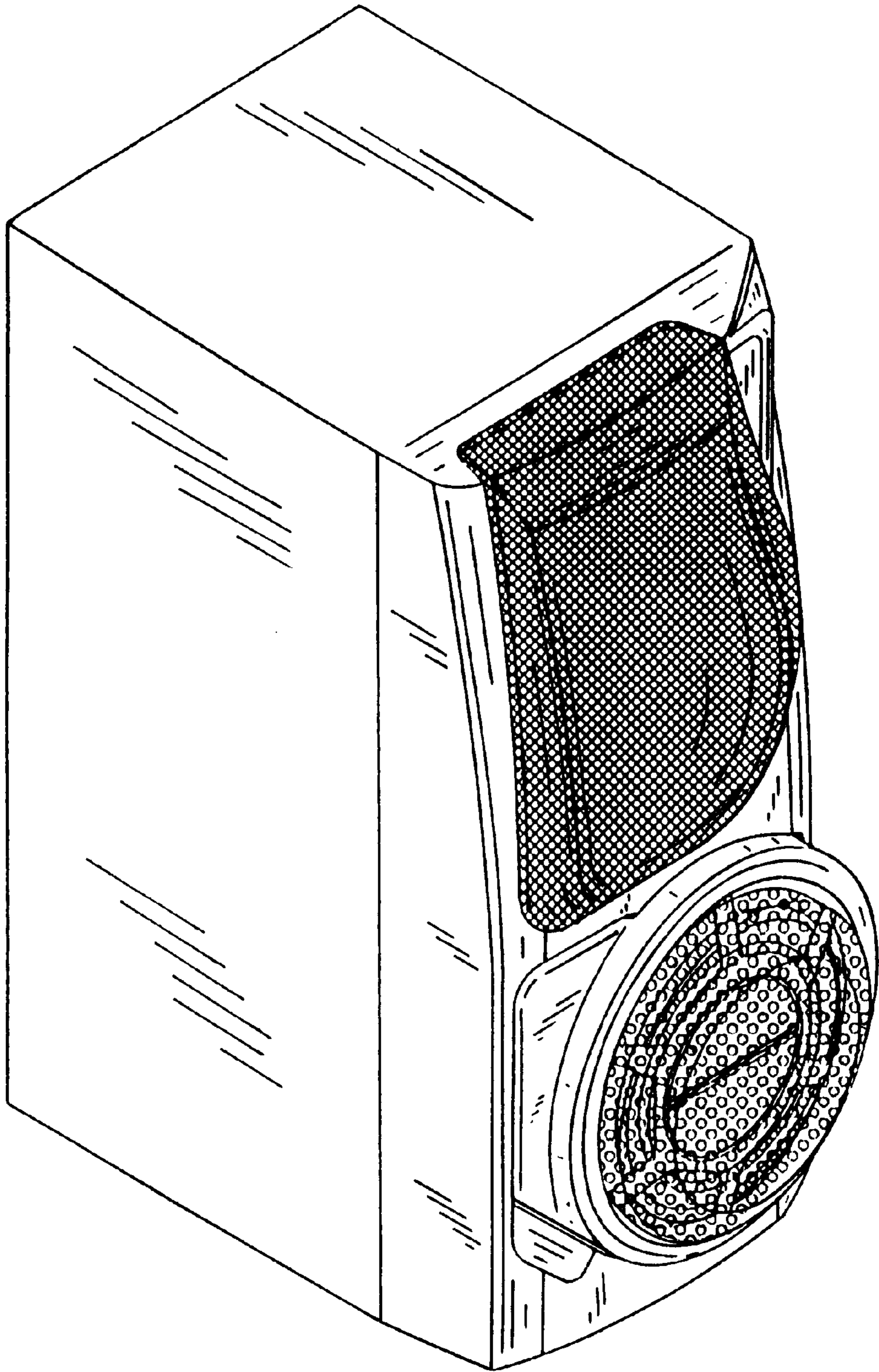

FIG. 9

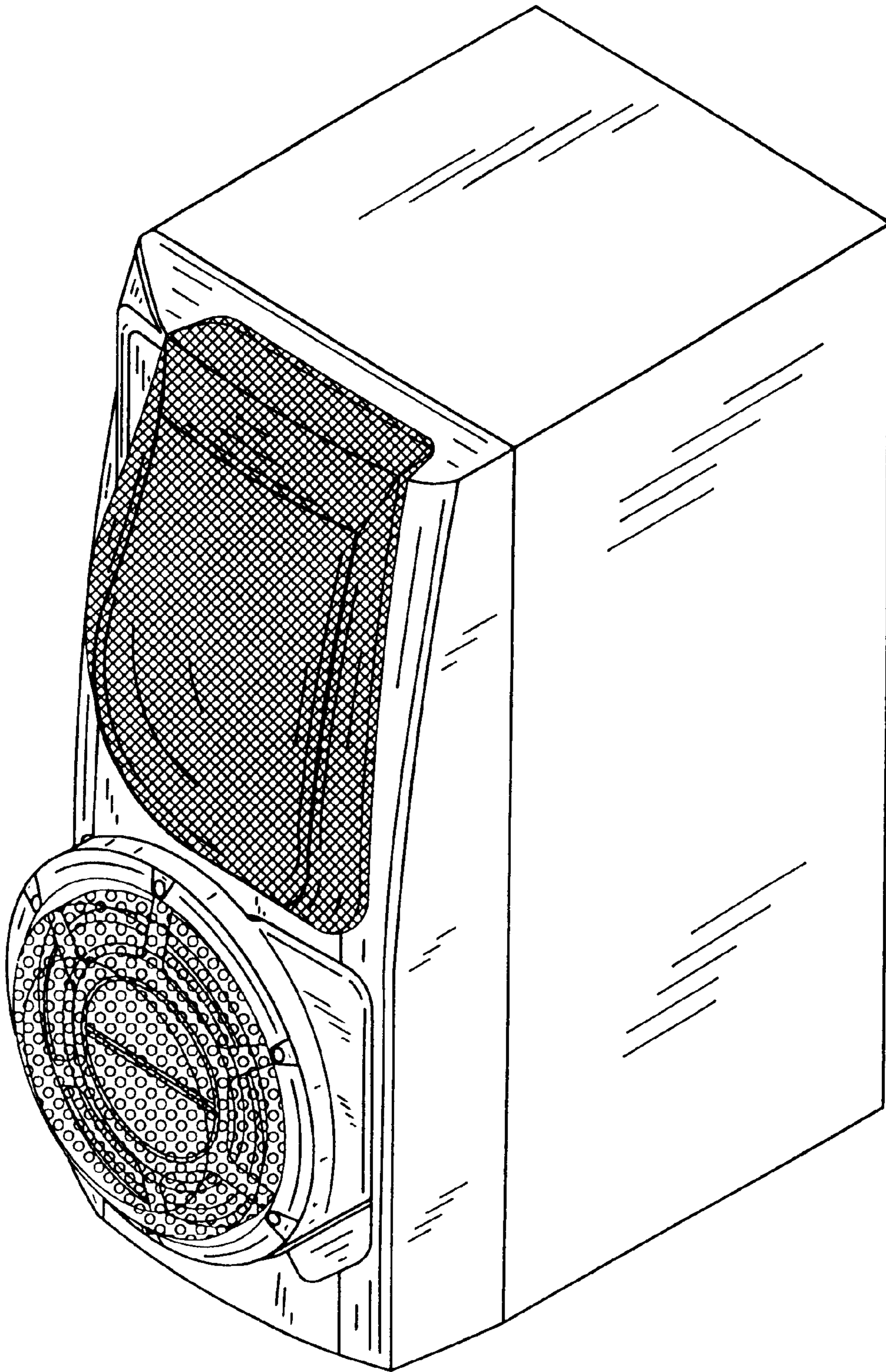

FIG.10

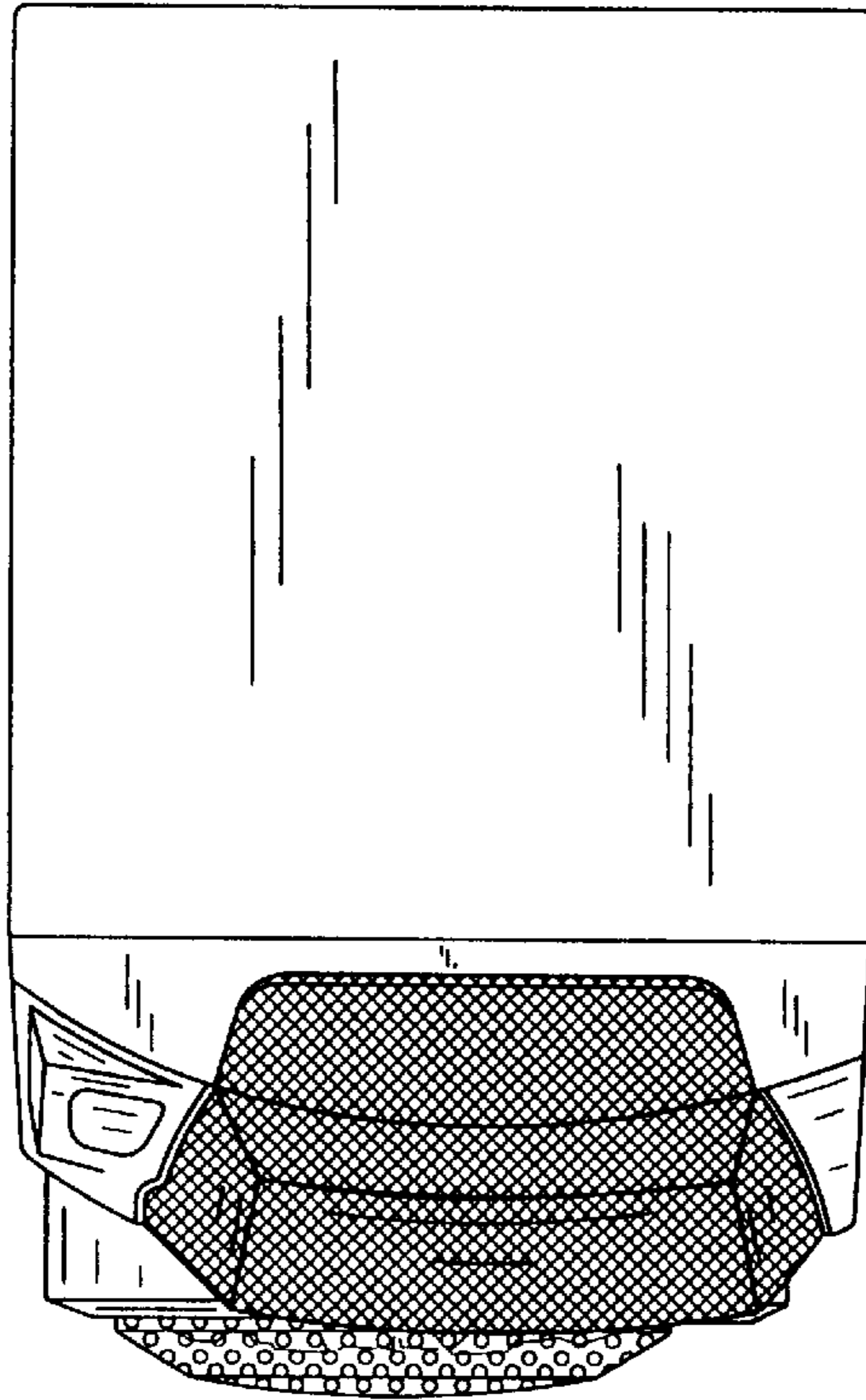

FIG.11

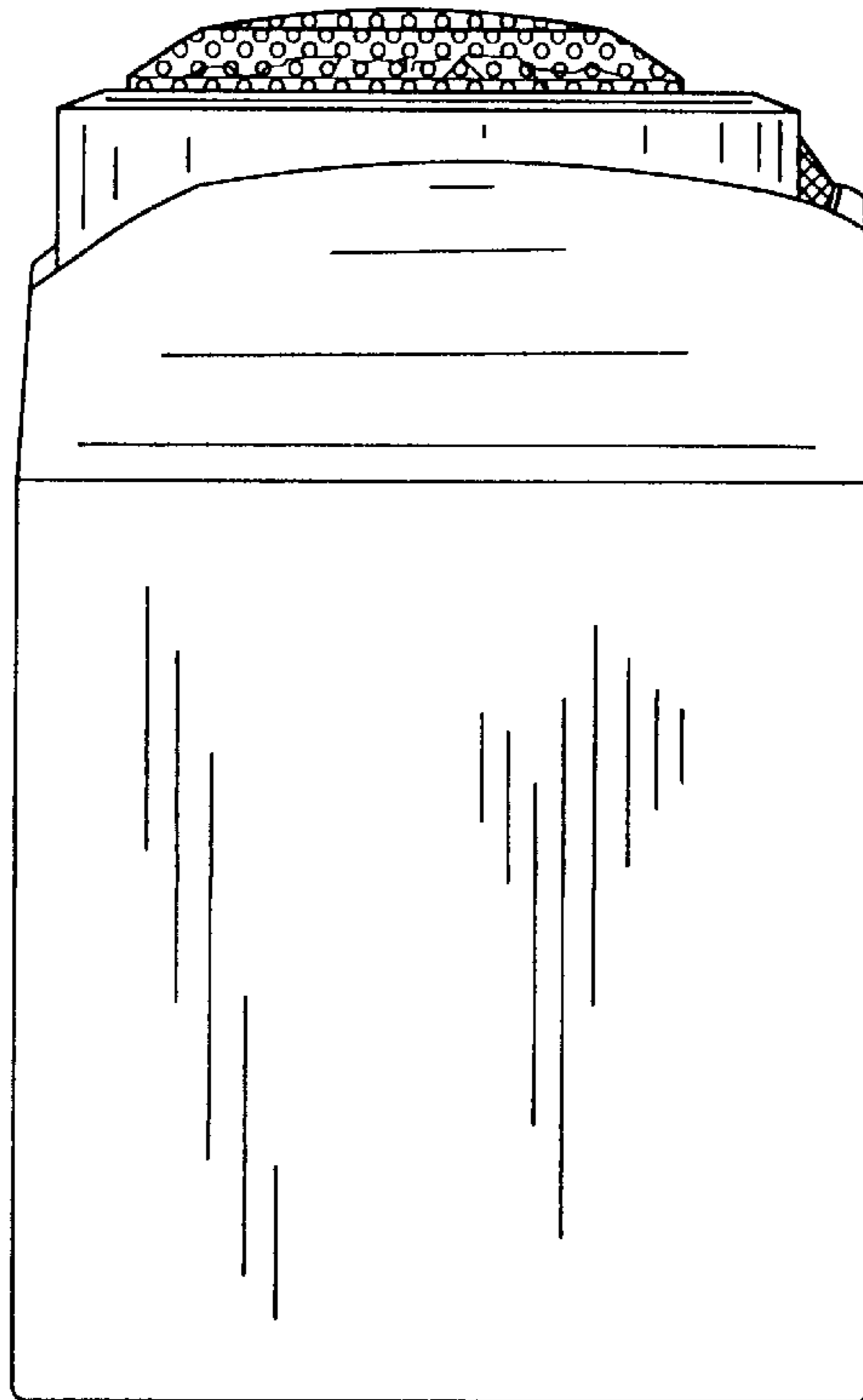



FIG.13

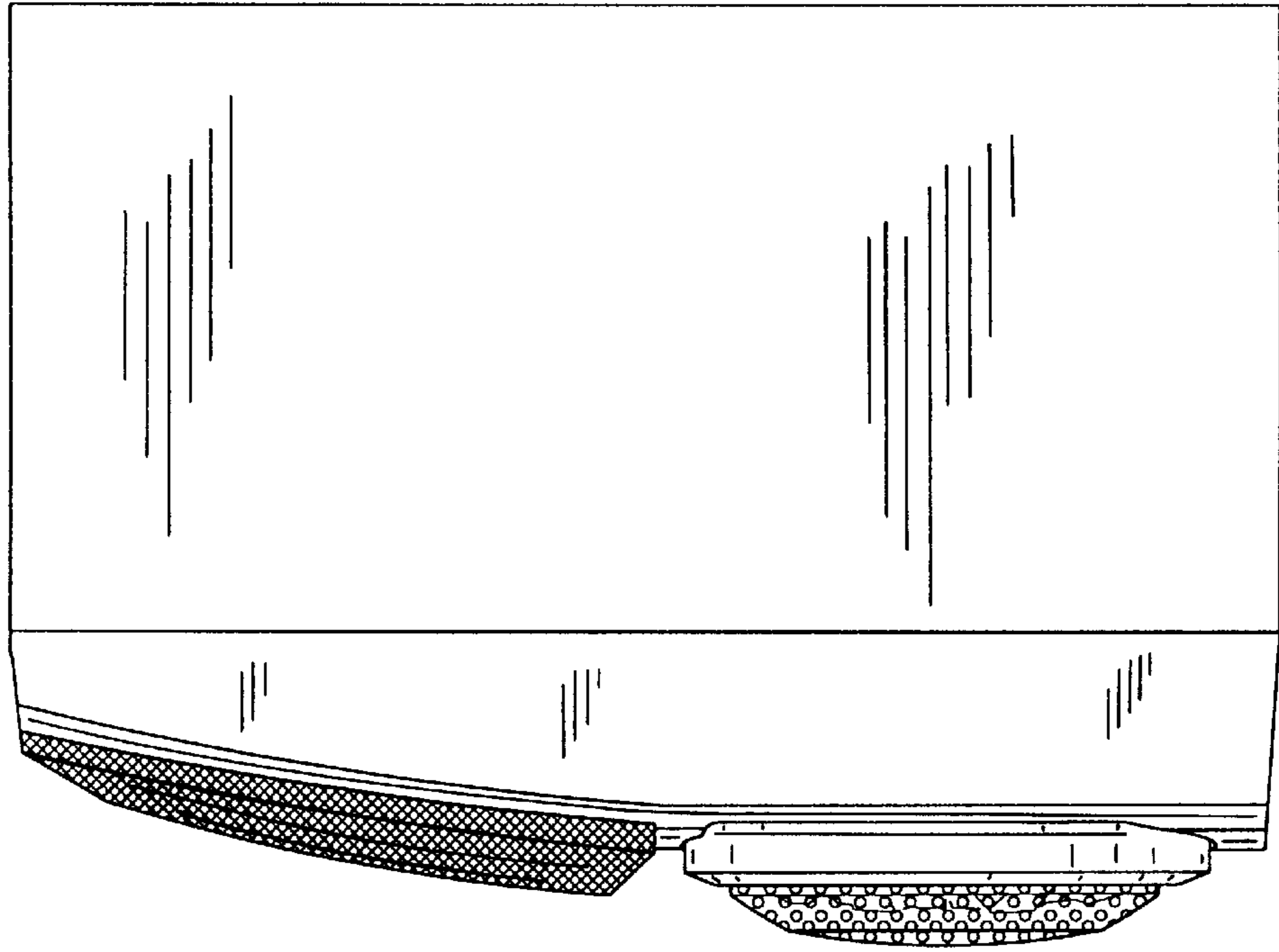

FIG.12

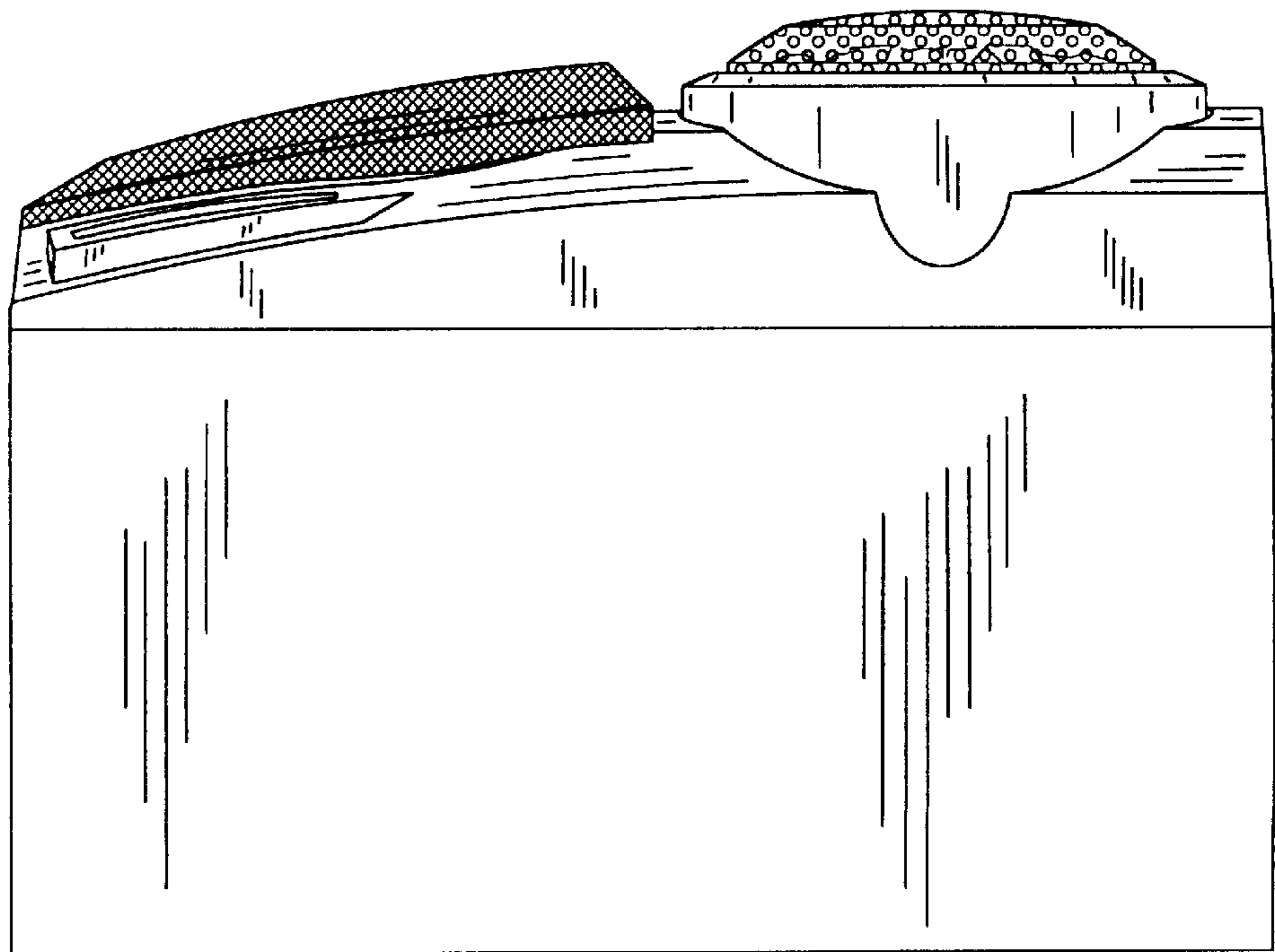

FIG. 15

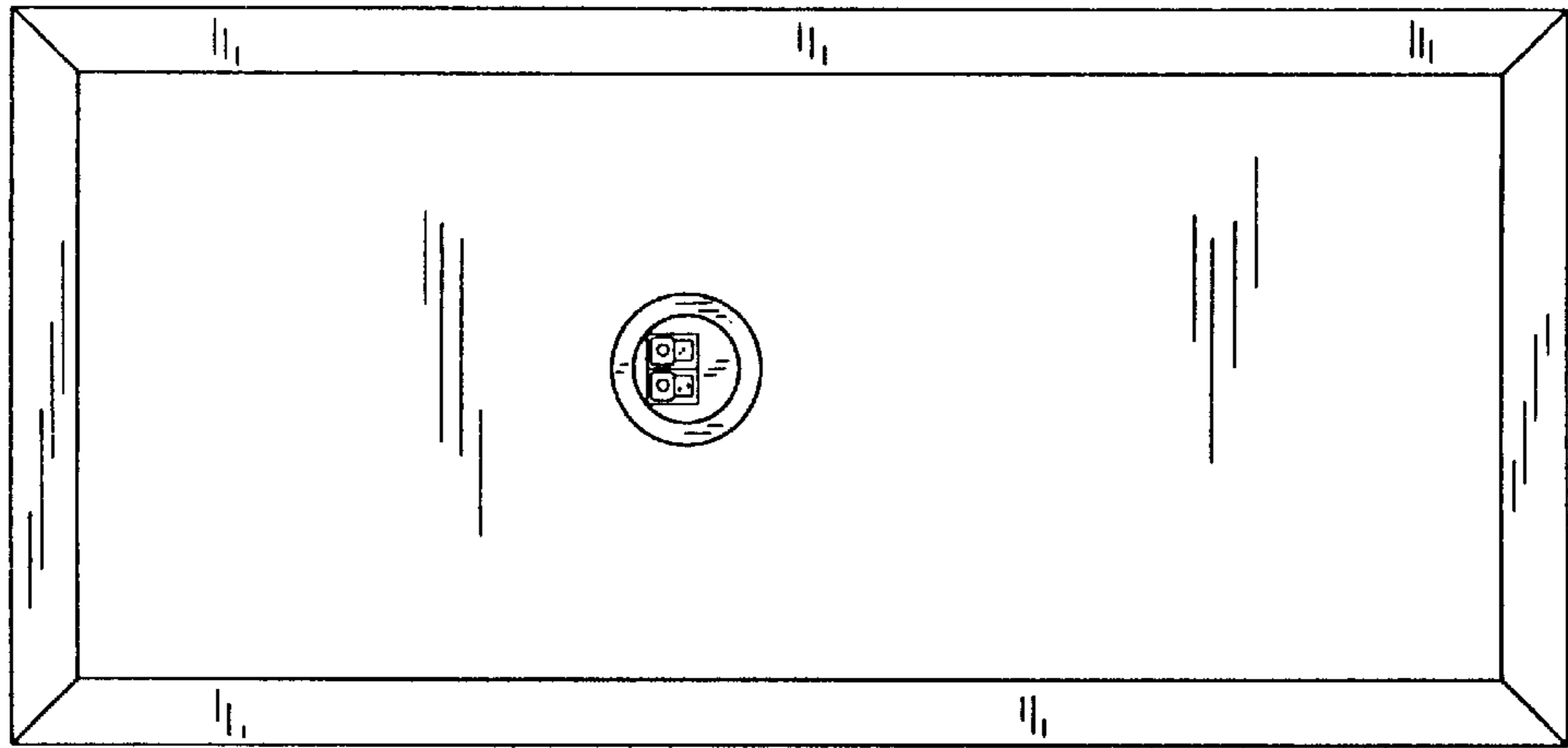

FIG. 14

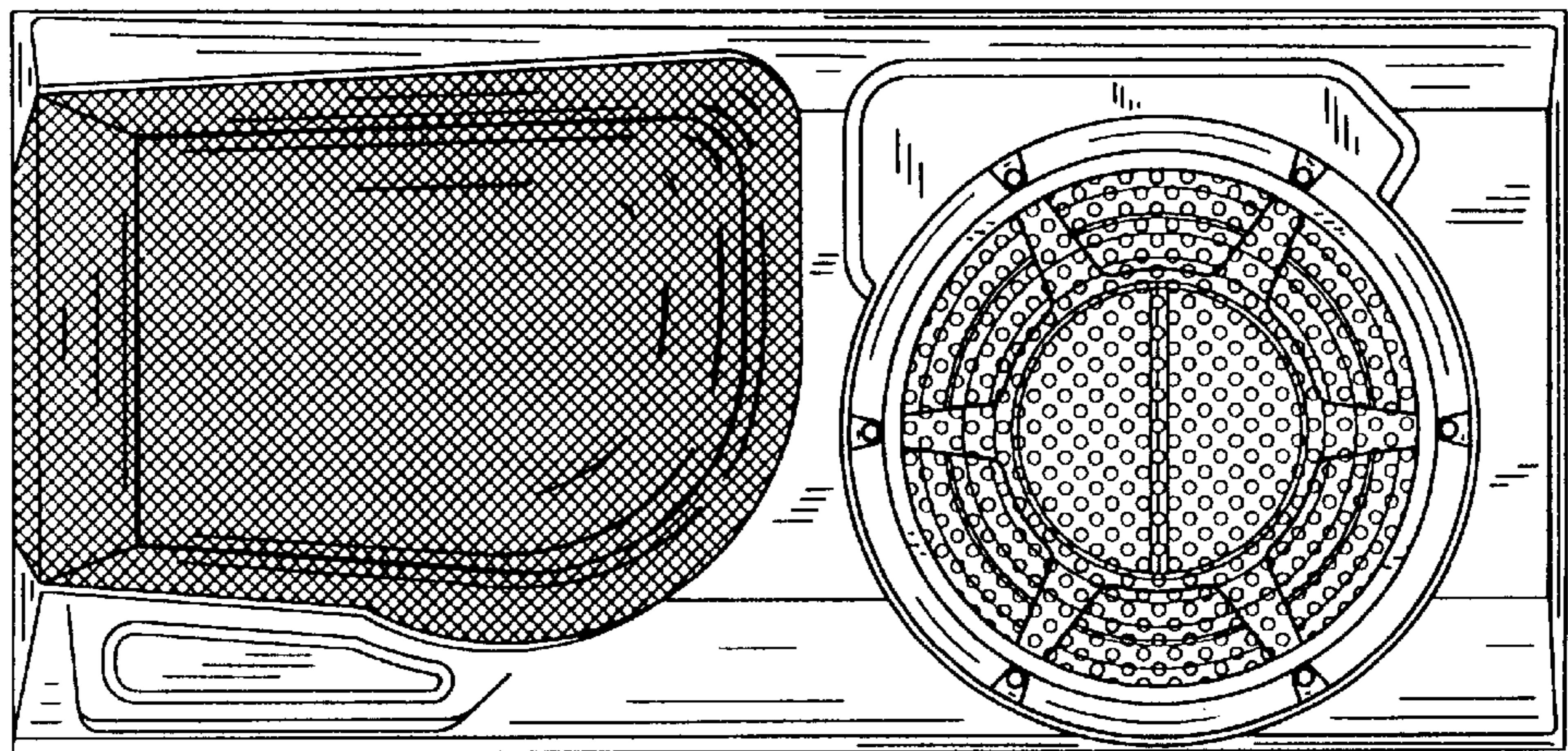

FIG. 16

