



US00D421909S

United States Patent [19]
Opresco

[11] **Patent Number: Des. 421,909**
[45] **Date of Patent: ** Mar. 28, 2000**

[54] **CHILD-RESISTANT SCREW-ON CAP**

[75] Inventor: **Ovidiu Opresco**, Long Island City, N.Y.

[73] Assignee: **Weatherchem Corporation**, Twinsburg, Ohio

[**] Term: **14 Years**

[21] Appl. No.: **29/103,029**

[22] Filed: **Apr. 7, 1999**

Related U.S. Application Data

[63] Continuation of application No. 08/835,826, Apr. 16, 1997, Pat. No. 5,908,125.

[51] **LOC (6) Cl.** **09-07**

[52] **U.S. Cl.** **D9/443**

[58] **Field of Search** D9/435, 443, 445, D9/454; 215/201, 216, 217, 208, 223, 295, 330, 331, 334; 220/260, 281, 288, 315, 327, 328, 345.2, 345.3

References Cited

U.S. PATENT DOCUMENTS

D. 329,809	9/1992	Bloomfield	D9/443
D. 397,612	9/1998	Lipnick	D9/445
D. 404,303	1/1999	Webster	D9/443
3,399,796	9/1968	Steiner	.	
3,612,323	10/1971	Malick	215/216 X
3,698,584	10/1972	Miller	.	
3,722,727	3/1973	Gach	.	
3,826,395	7/1974	Montgomery	.	

3,831,797	8/1974	Stevens, Jr.	.	
3,841,514	10/1974	Montgomery et al.	.	
3,895,730	7/1975	Koehne et al.	215/216
4,172,533	10/1979	Montgomery	215/216
4,326,649	4/1982	Marino et al.	220/281 X
4,401,225	8/1983	Schwaikert	220/281 X
4,413,742	11/1983	Sandhaus	215/216
4,479,585	10/1984	Sandhaus	215/216 X
4,500,006	2/1985	Lafortune et al.	220/218 X
4,687,112	8/1987	Swartzbaugh	215/216
4,752,013	6/1988	Miller et al.	215/216
4,752,014	6/1988	House et al.	215/216
5,213,223	5/1993	Minnette	215/216
5,449,077	9/1995	Seidler	215/216
5,603,421	2/1997	Opresco	215/217
5,671,853	9/1997	Herr	215/216
5,836,467	11/1998	Montgomery	215/216

Primary Examiner—Cathron B. Matta
Attorney, Agent, or Firm—Pearne, Gordon, McCoy & Granger LLP

[57] **CLAIM**

The ornamental design for a child-resistant screw-on cap, as shown and described.

DESCRIPTION

FIG. 1 is a top perspective view of a child-resistant screw-on cap showing my new design;
FIG. 2 is a bottom perspective view thereof;
FIG. 3 is a top plan view thereof;
FIG. 4 is a bottom plan view thereof;
FIG. 5 is a front elevational view thereof; and,
FIG. 6 is a side elevational view thereof.

1 Claim, 1 Drawing Sheet

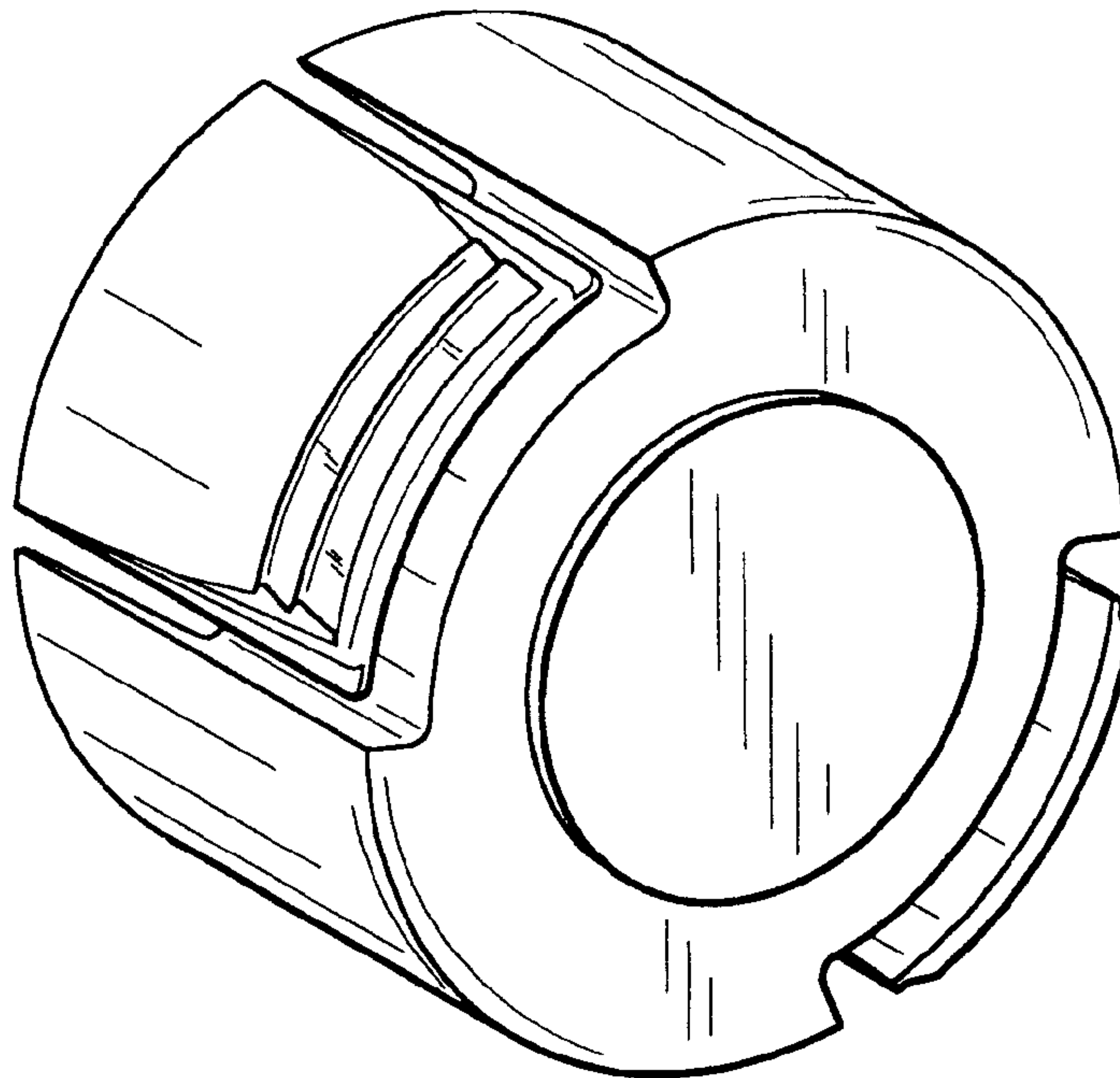

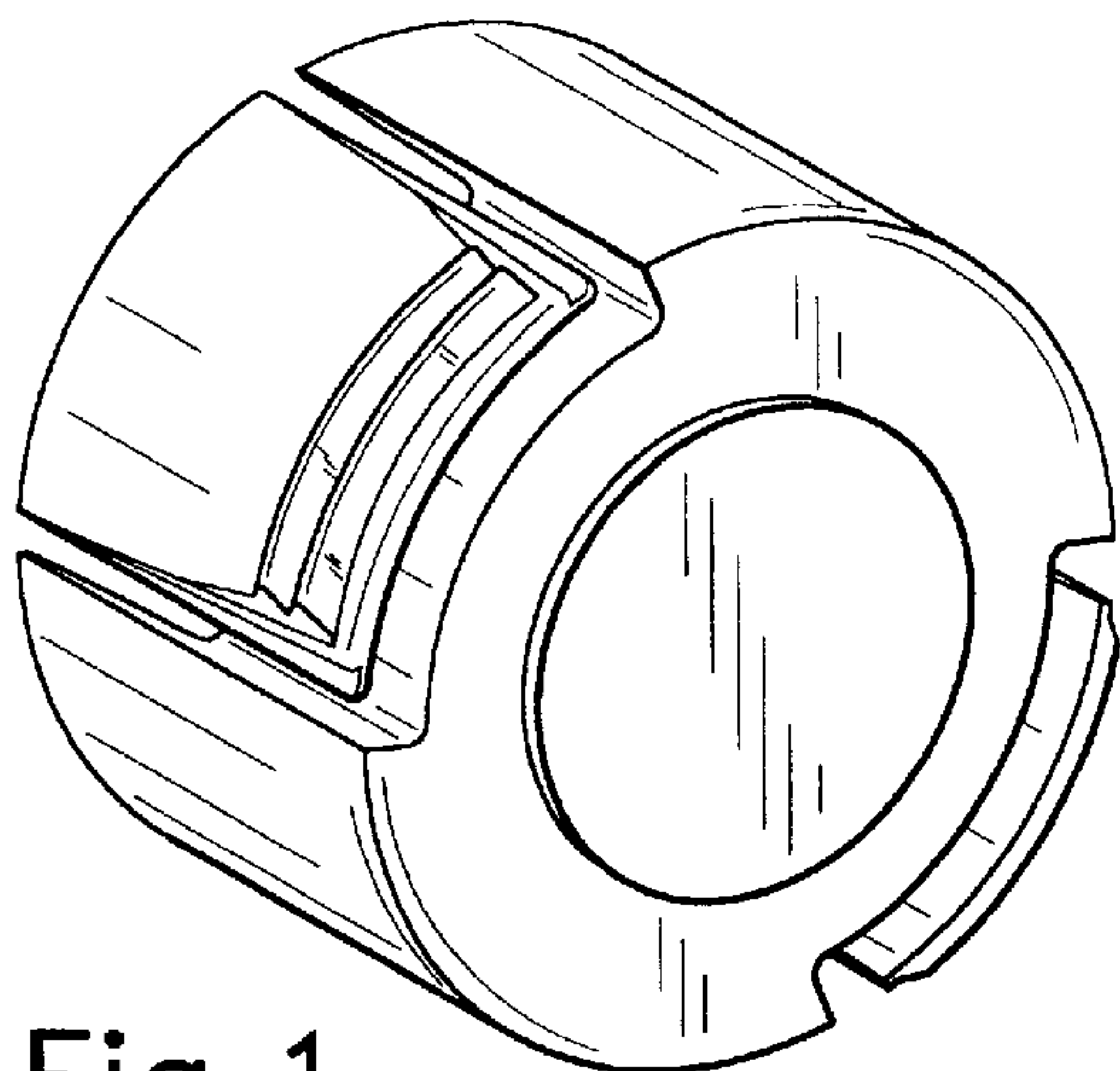

Fig. 1

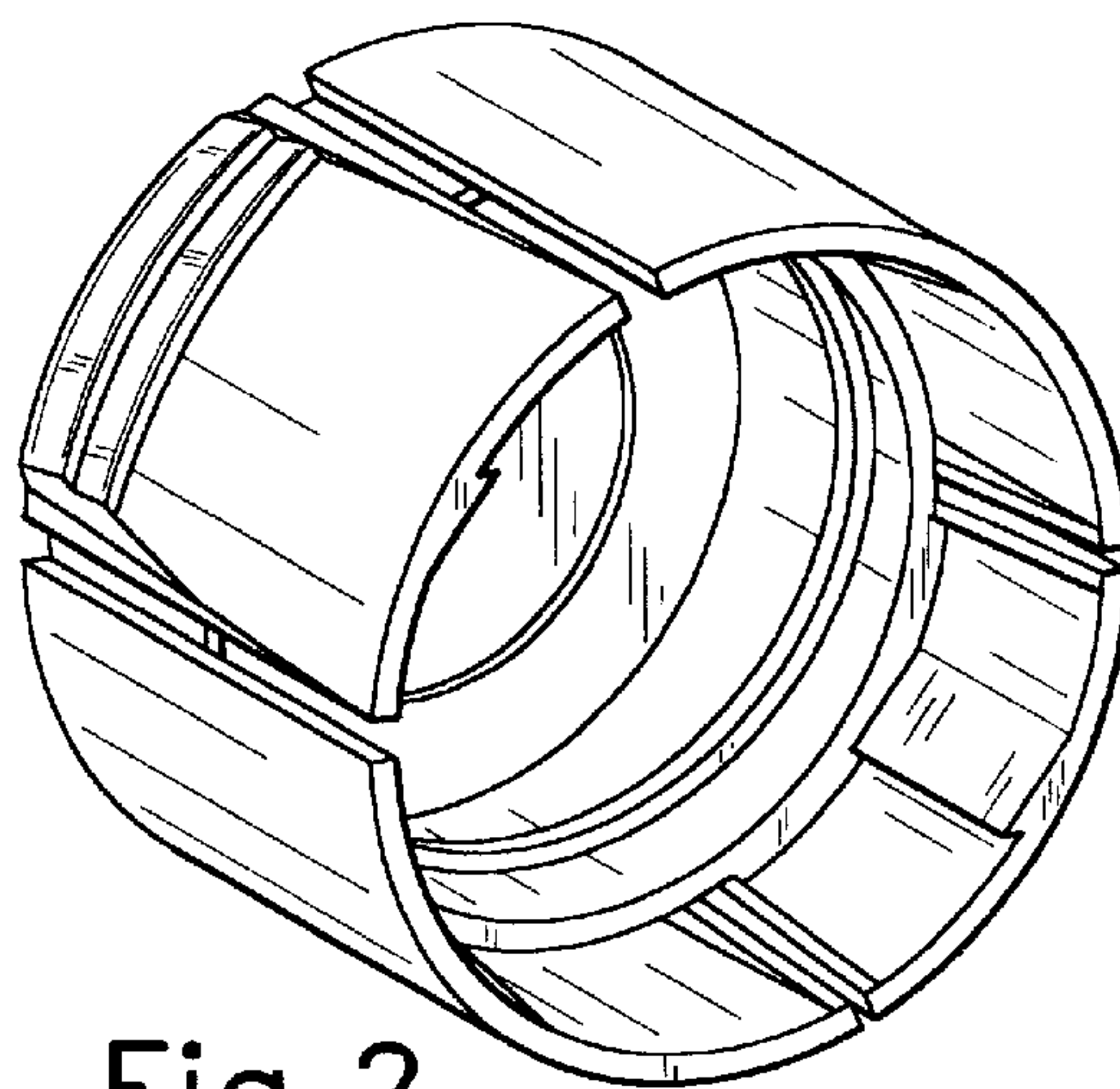

Fig. 2

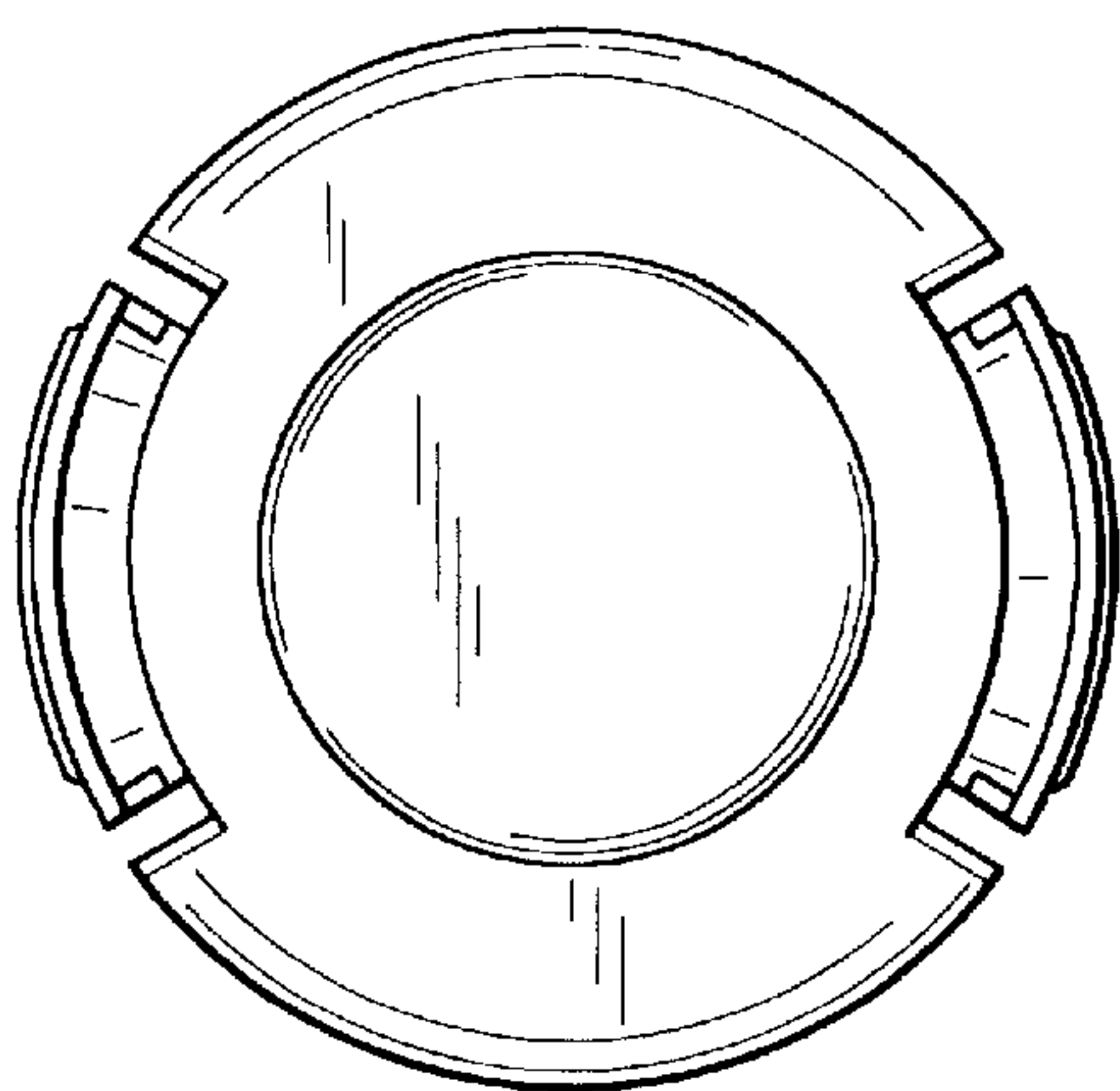

Fig. 3

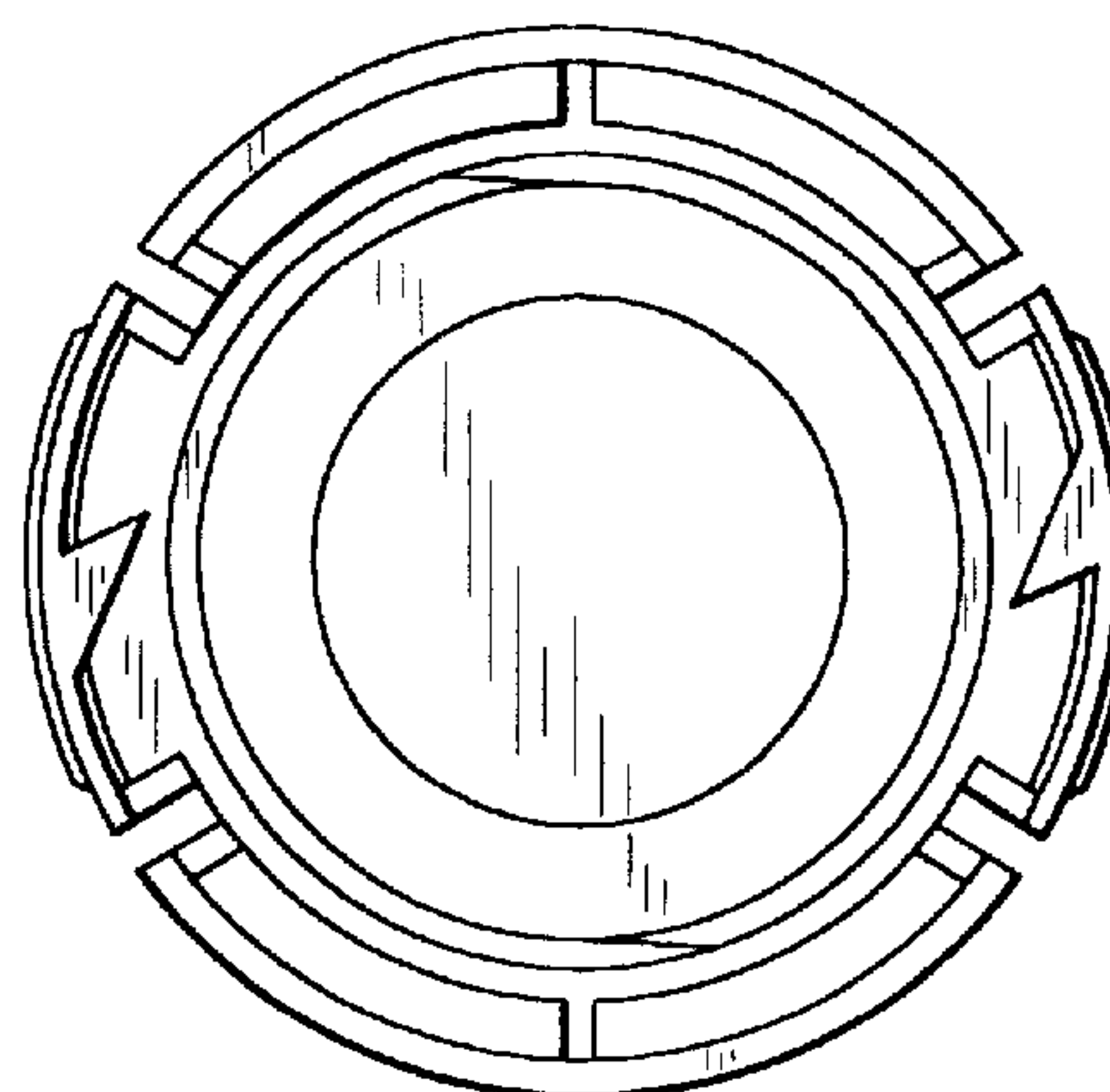

Fig. 4

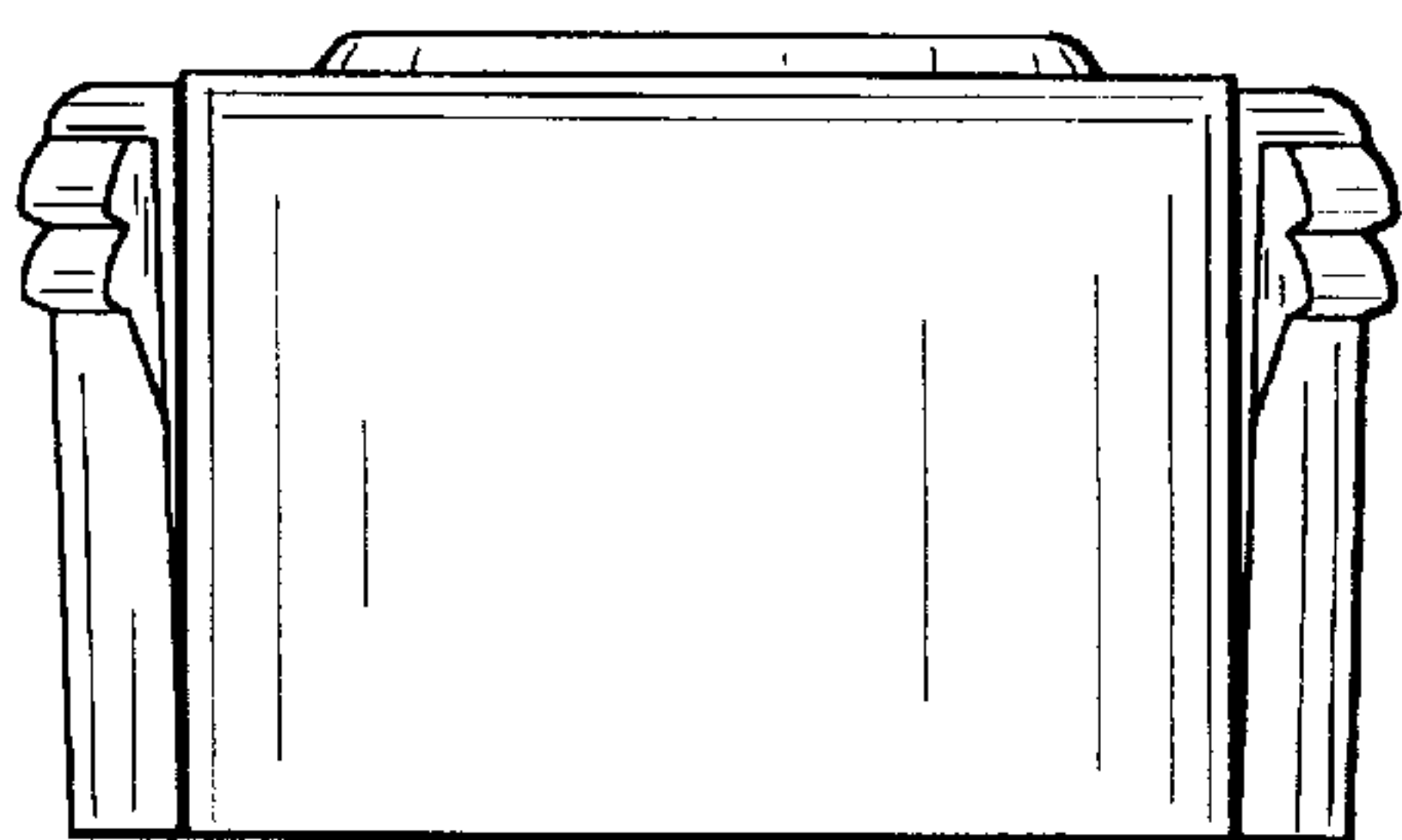

Fig. 5

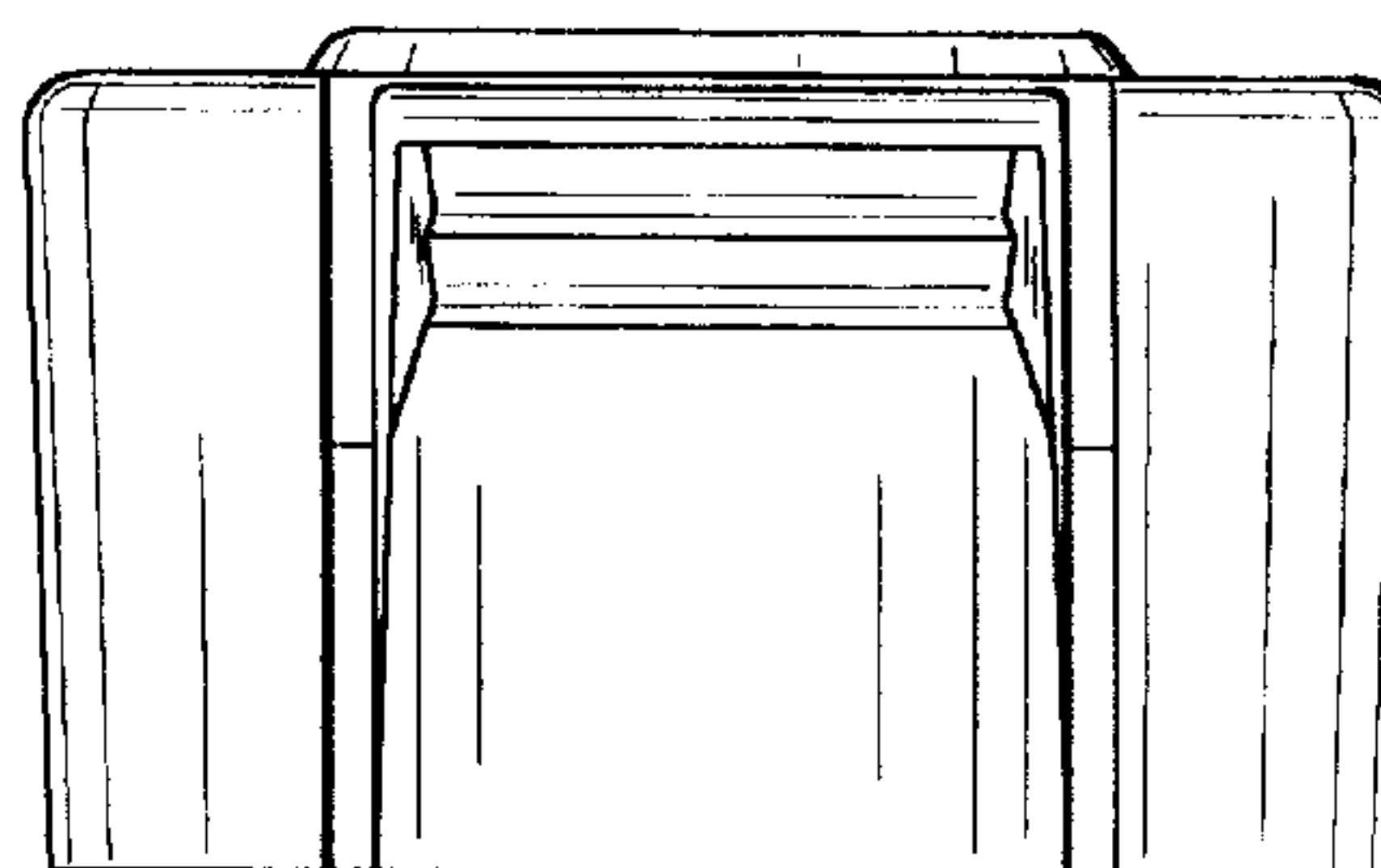

Fig. 6