



US00D421904S

United States Patent [19]
Zaksenberg

[11] **Patent Number: Des. 421,904**

[45] **Date of Patent: ** Mar. 28, 2000**

[54] **FIGURINE ATTACHED TO THE DIP TUBE OF A CONTAINER**

D. 338,618 8/1993 Berkeley D9/441 X
D. 346,327 4/1994 Berkeley D9/441
D. 392,148 3/1998 Lewis D7/300.2
5,915,600 6/1999 Bitton 222/78 X

[75] Inventor: **Issac Zaksenberg**, Scotch Plains, N.J.

[73] Assignee: **Colgate-Palmolive Company**, New York, N.Y.

Primary Examiner—Cathron B. Matta
Attorney, Agent, or Firm—Michael McGreal

[**] Term: **14 Years**

[57] **CLAIM**

[21] Appl. No.: **29/103,488**

The ornamental design for a figurine attached to the dip tube of a container, as shown and described.

[22] Filed: **Apr. 15, 1999**

DESCRIPTION

[51] **LOC (6) Cl.** **09-07**

[52] **U.S. Cl.** **D9/434; D9/300; D9/310; D9/336**

[58] **Field of Search** D9/300, 301, 307, D9/310, 318, 336, 434, 441, 451; D7/300.2; 215/229, 388; 220/212, 705, 707; 222/78; 239/33, 211; D21/597, 600, 601, 604, 623, 650

FIG. 1 is a perspective view of the figurine attached to the dip tube of a container on a flower of my design attached to a dip tube of a container.

FIG. 2 is a left side elevation view thereof.

FIG. 3 is a right side elevation view thereof.

FIG. 4 is a top plan view thereof.

FIG. 5 is a bottom plan view thereof.

FIG. 6 is a front elevation view thereof; and,

FIG. 7 is a back elevation view thereof.

The broken line showing of a container and pump is for illustrative purposes only and forms no part of the claimed design.

[56] **References Cited**

U.S. PATENT DOCUMENTS

D. 197,387 1/1964 Smith D9/318
D. 198,857 8/1964 Rabin D21/600 X

1 Claim, 3 Drawing Sheets

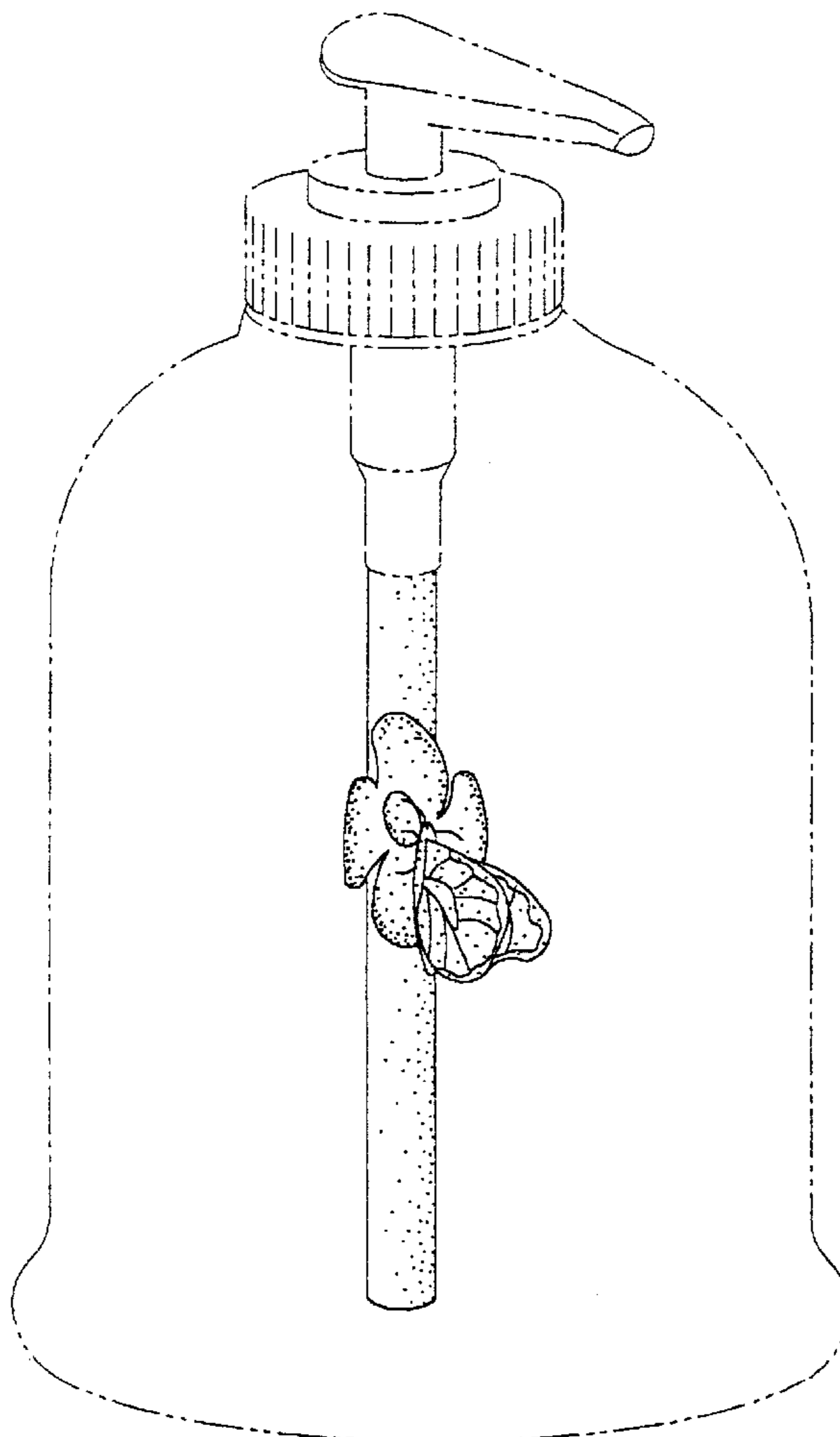

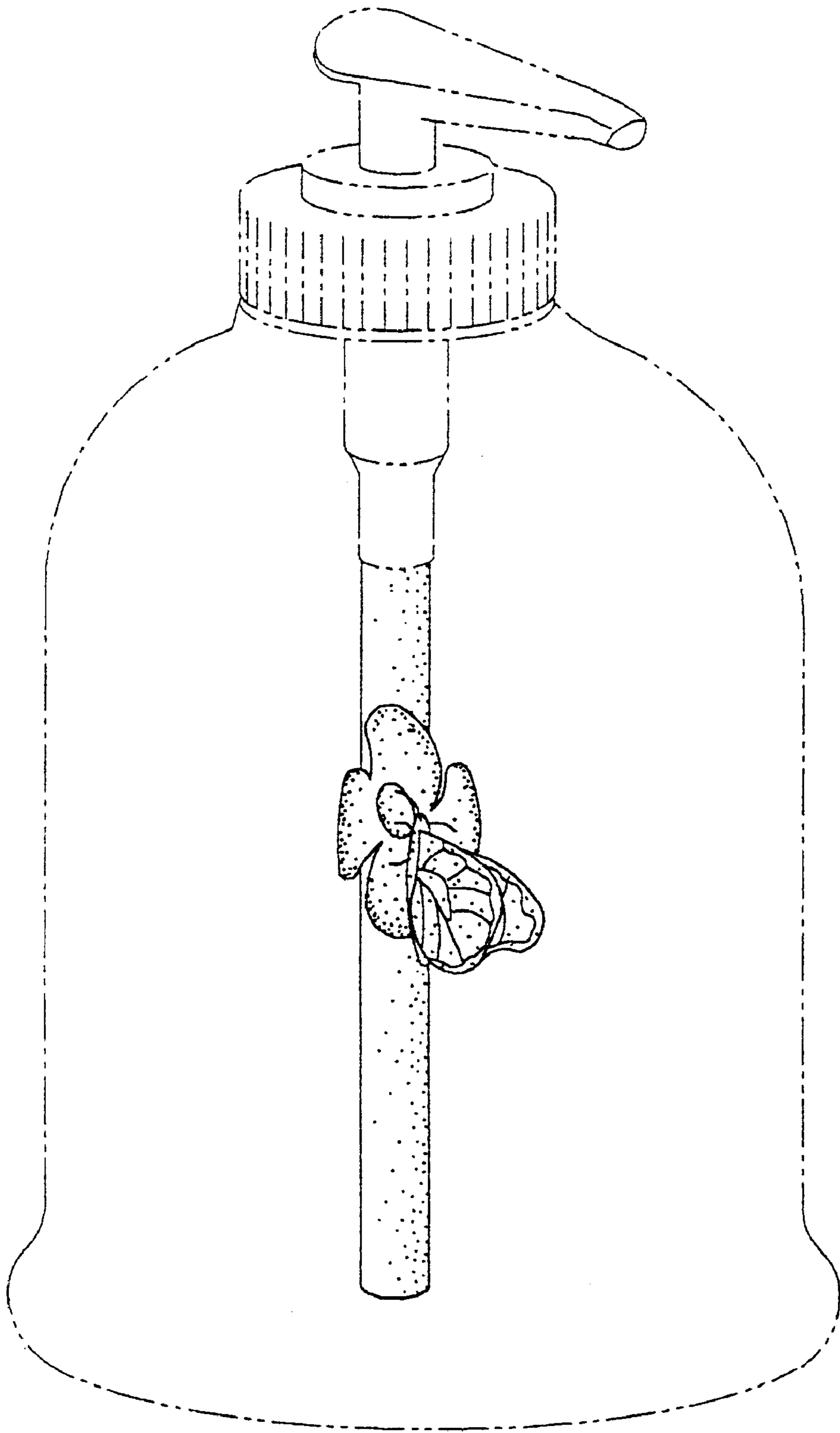

FIG. 1

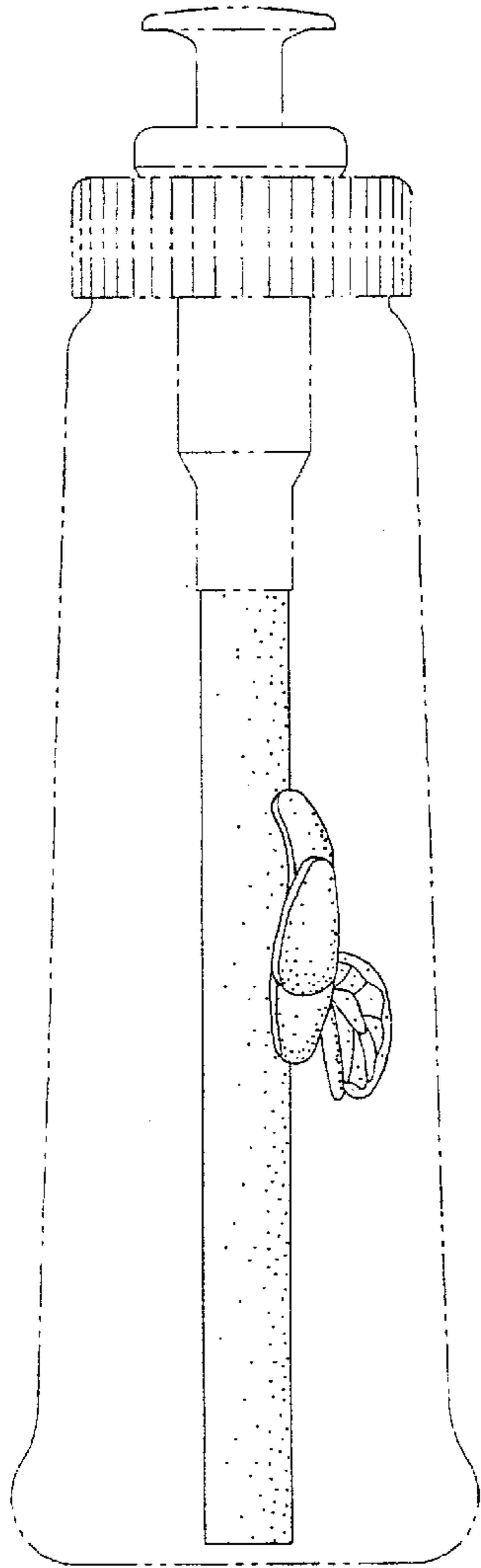

FIG. 2

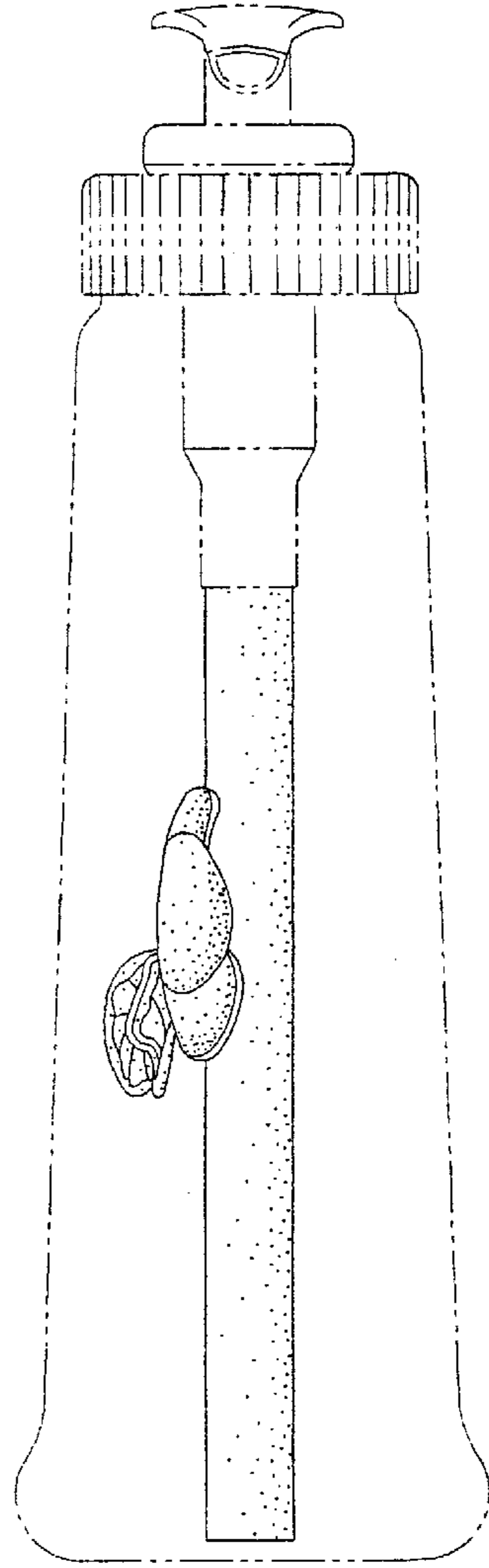

FIG. 3

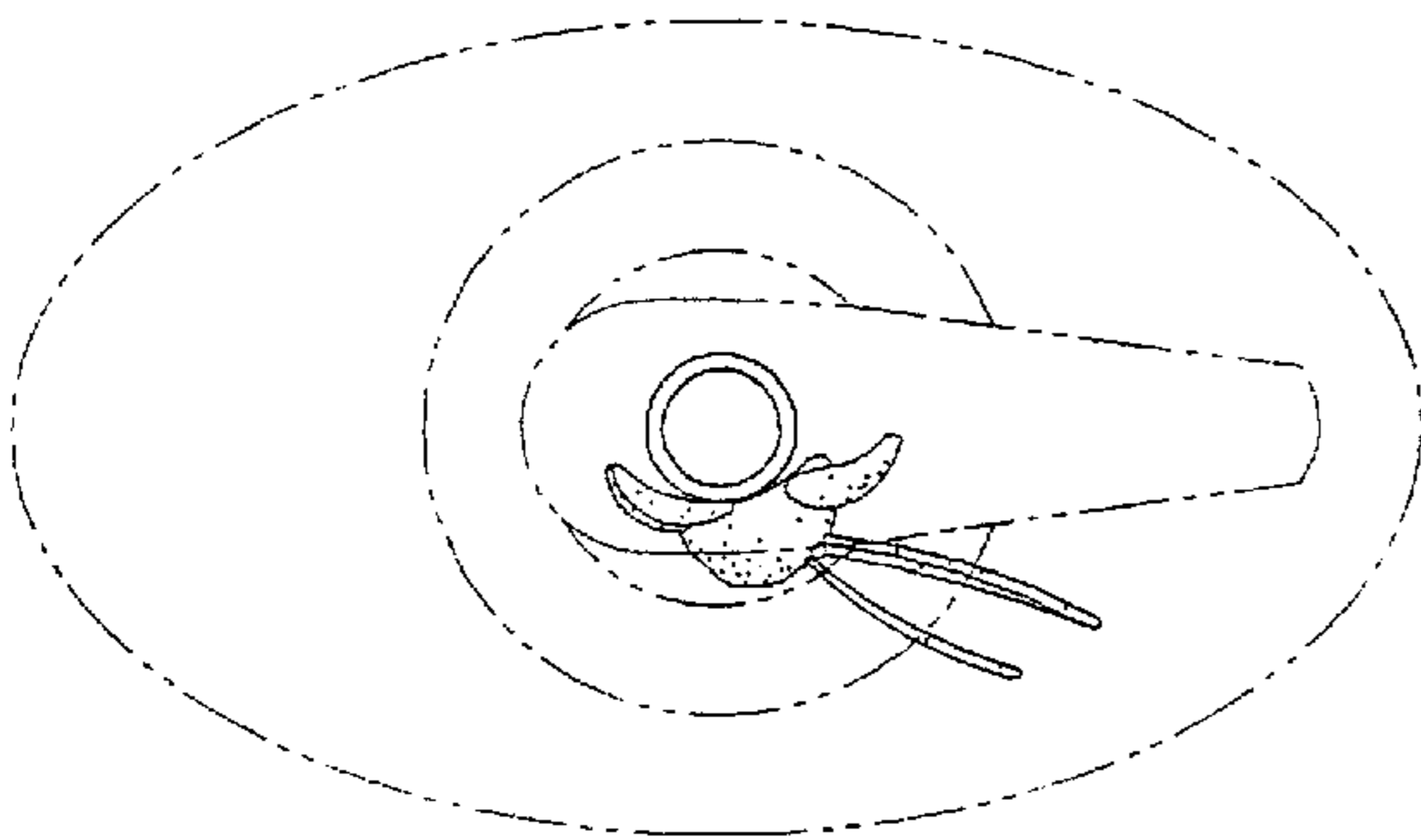

FIG. 4

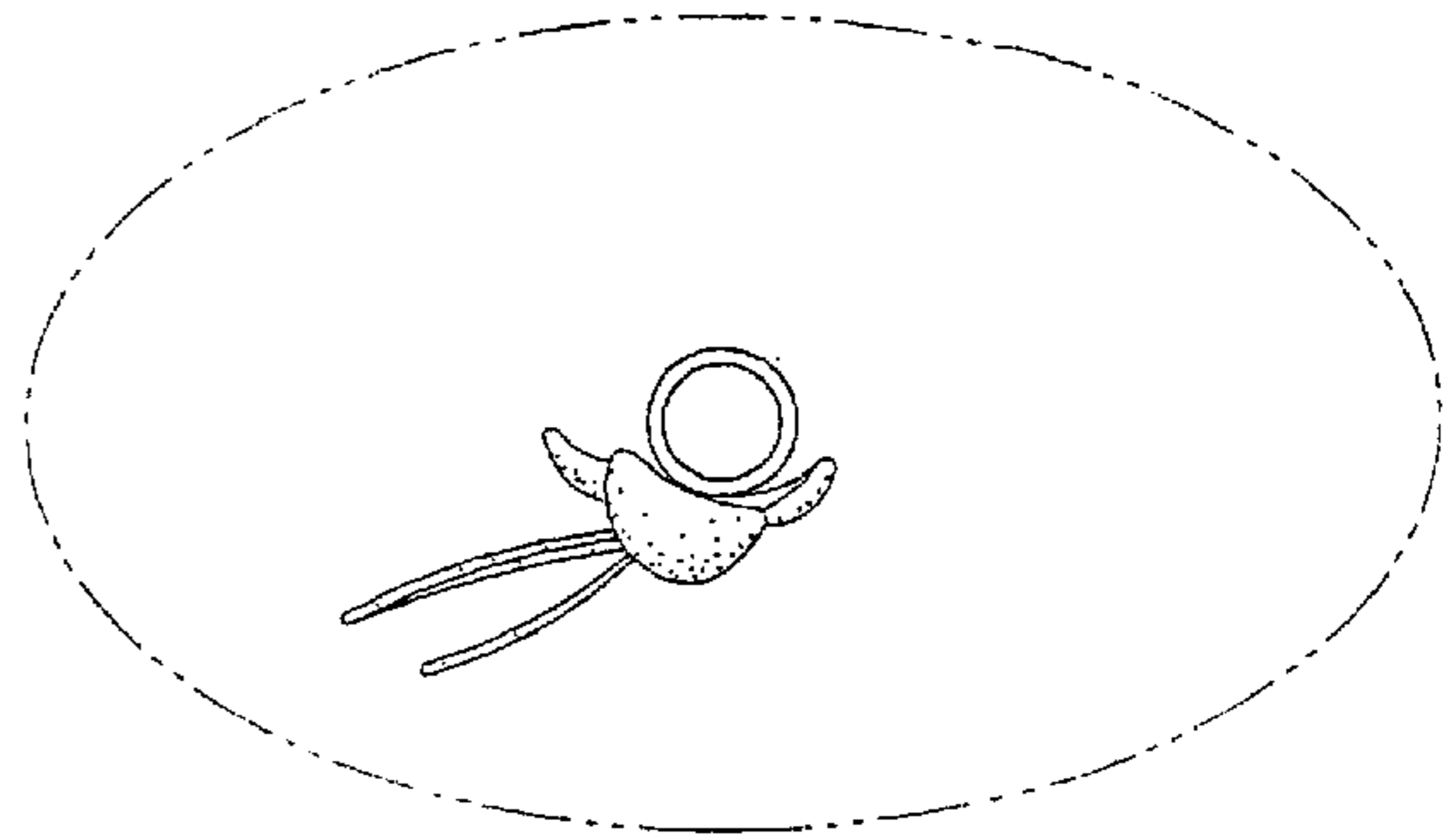

FIG. 5

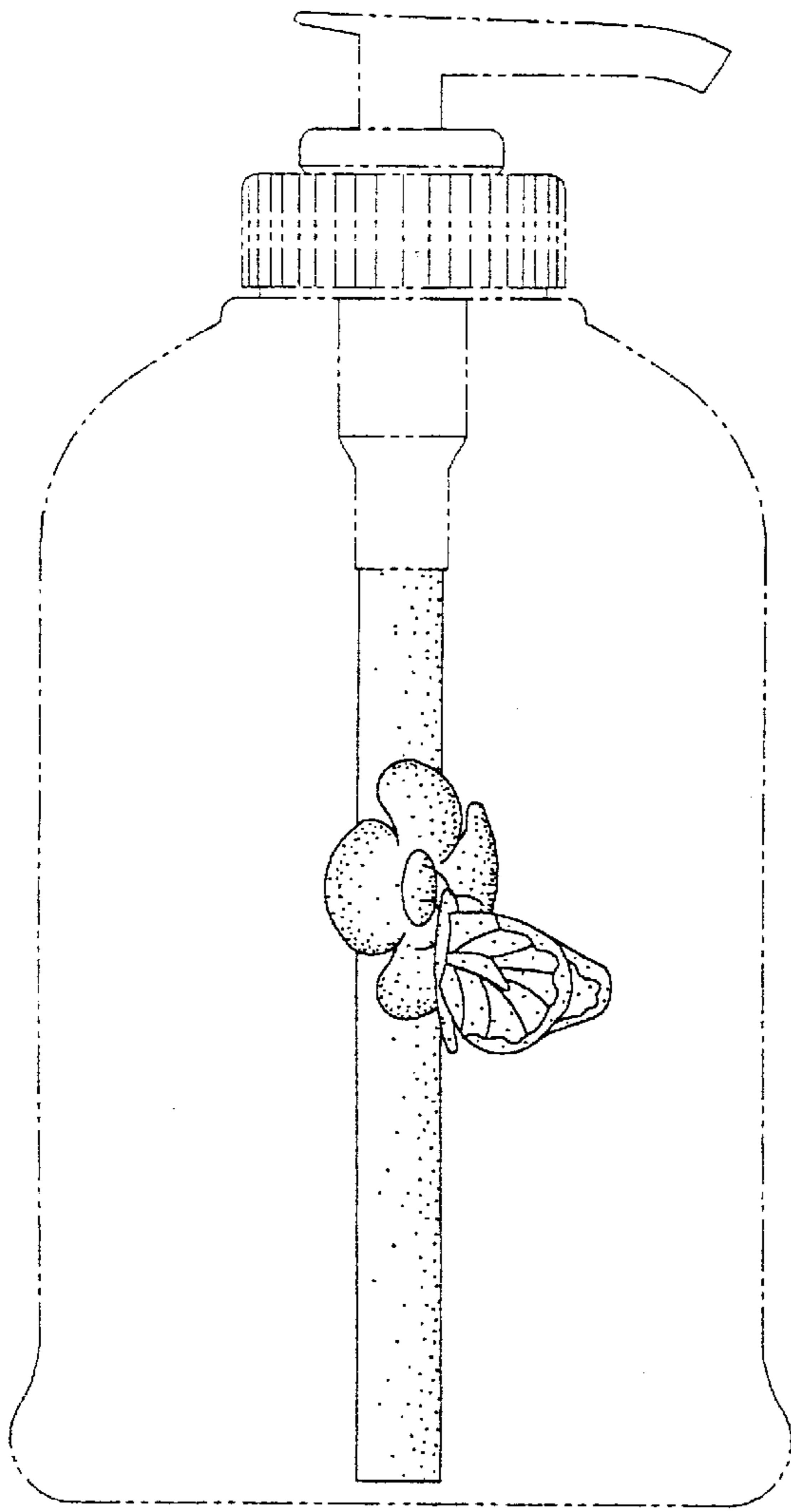

FIG. 6

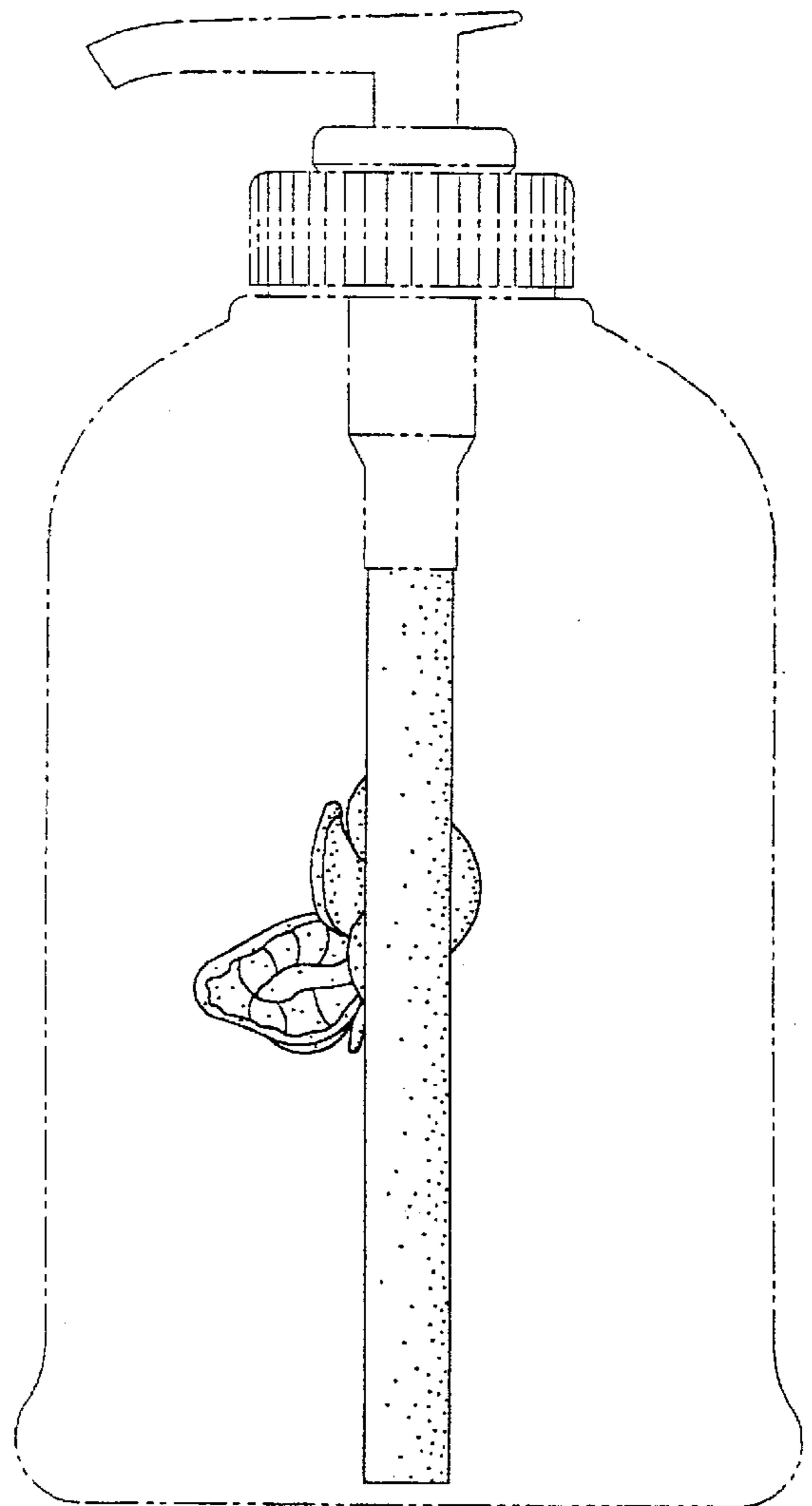

FIG. 7