



US00D421878S

United States Patent [19] Roehrig

[11] Patent Number: **Des. 421,878**

[45] Date of Patent: **** Mar. 28, 2000**

[54] **CLOSEABLE DRINKING CUP**

[75] Inventor: **Peter Roehrig**, Vienna, Austria

[73] Assignee: **Mam Babyartikel Gesellschaft m.b.H.**,
Vienna, Austria

[**] Term: **14 Years**

[21] Appl. No.: **29/106,833**

[22] Filed: **Jun. 22, 1999**

[51] **LOC (6) Cl.** **07-01**

[52] **U.S. Cl.** **D7/510; D7/511; D7/534**

[58] **Field of Search** **D7/507, 509, 510,**
D7/511, 514, 515, 533, 534, 536; 220/715,
711, 713, 714; 215/229; D24/197

[56] **References Cited**

U.S. PATENT DOCUMENTS

D. 216,730	3/1970	Carslaw	D7/534
D. 233,972	12/1974	Juhlin	D7/534
D. 322,196	12/1991	Ohnuki	D7/510
D. 324,624	3/1992	Mayers	D7/510
D. 326,796	6/1992	Kawano	D7/510
D. 329,355	9/1992	Tagi	D7/511
D. 347,552	6/1994	Green	D7/534

D. 353,972	1/1995	Robling et al.	D7/511 X
D. 354,416	1/1995	Cautereels et al.	D7/507
D. 358,298	5/1995	Brown et al.	D7/510 X
D. 366,987	2/1996	Allegre	D7/510
D. 371,936	7/1996	Goto et al.	D7/509 X
D. 383,941	9/1997	Petrie	D7/511
D. 388,281	12/1997	Trombley	D7/515
D. 393,315	4/1998	Crisi	D24/197
D. 407,269	3/1999	Fletcher	D7/510
5,294,018	3/1994	Boucher	220/711

Primary Examiner—M. N. Pandozzi
Attorney, Agent, or Firm—Abelman, Frayne & Schwab

[57] **CLAIM**

I claim the ornamental design for a closeable drinking cup, as shown and described.

DESCRIPTION

FIG. 1 is a perspective view of my design;
FIG. 2 is a front view thereof;
FIG. 3 is a rear view thereof;
FIG. 4 is a left side view thereof;
FIG. 5 is a right side view thereof;
FIG. 6 is a top plan view thereof; and,
FIG. 7 is a bottom plan view thereof.

1 Claim, 7 Drawing Sheets

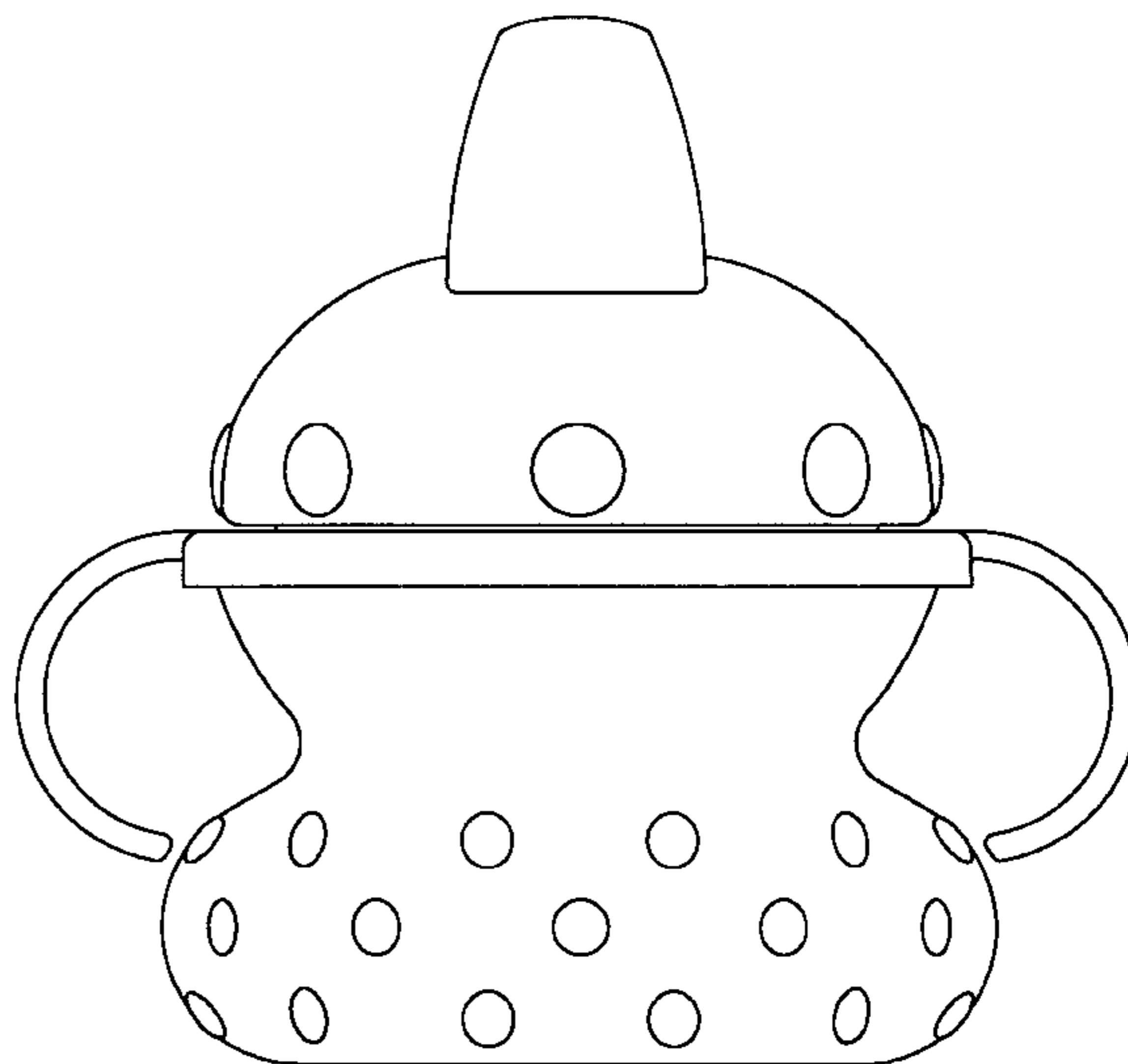
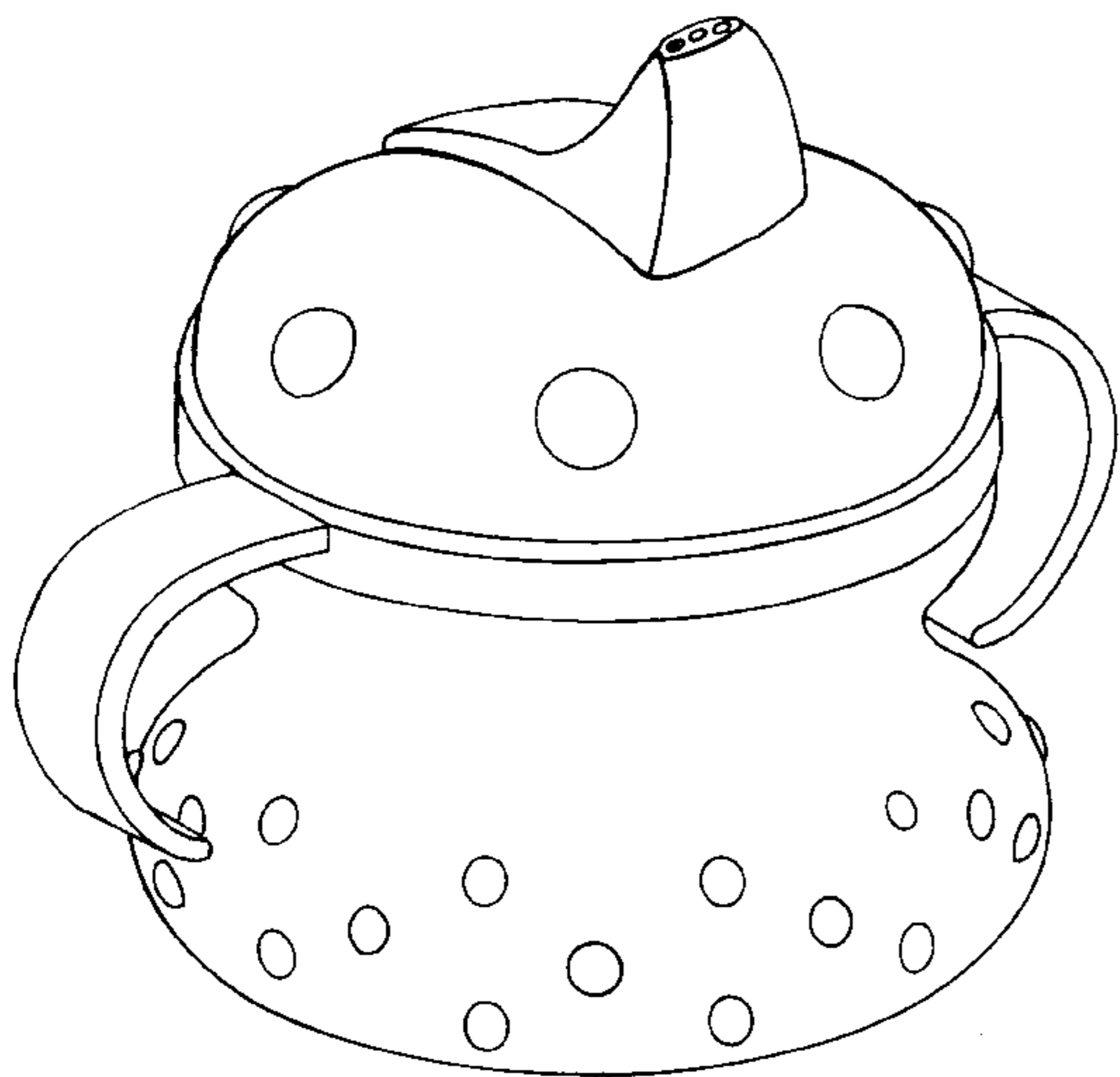

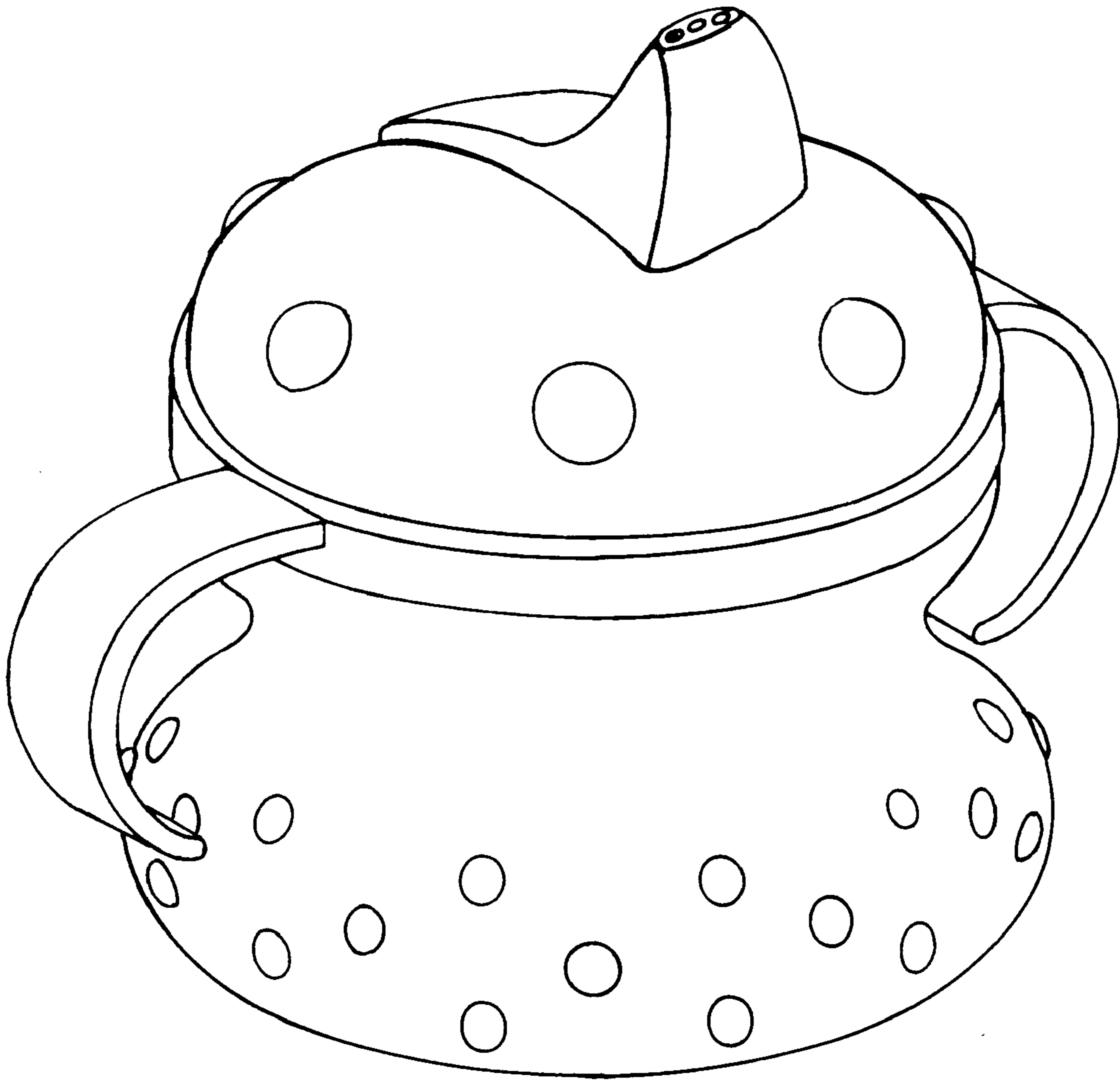

FIG. 1

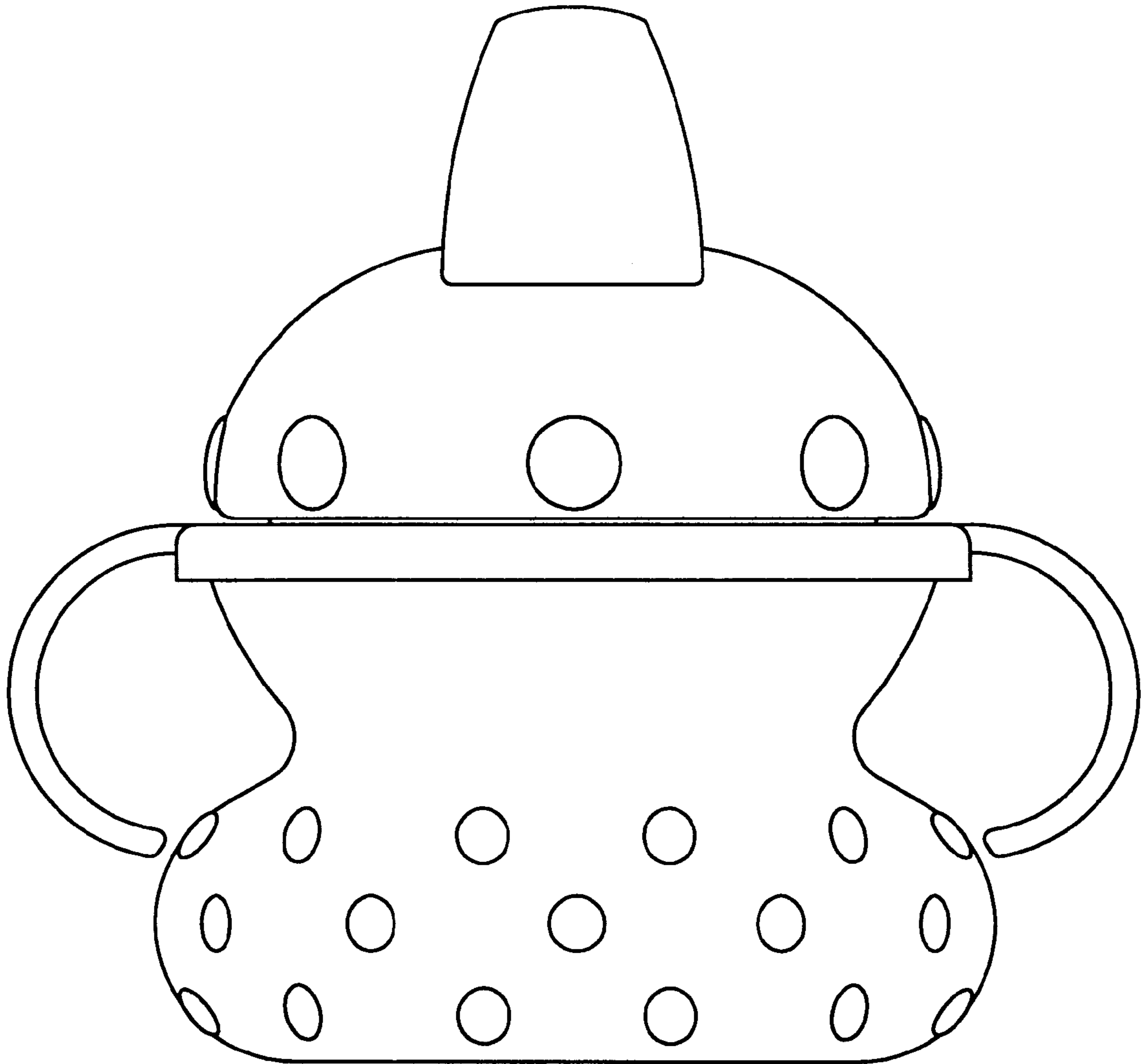

FIG. 2

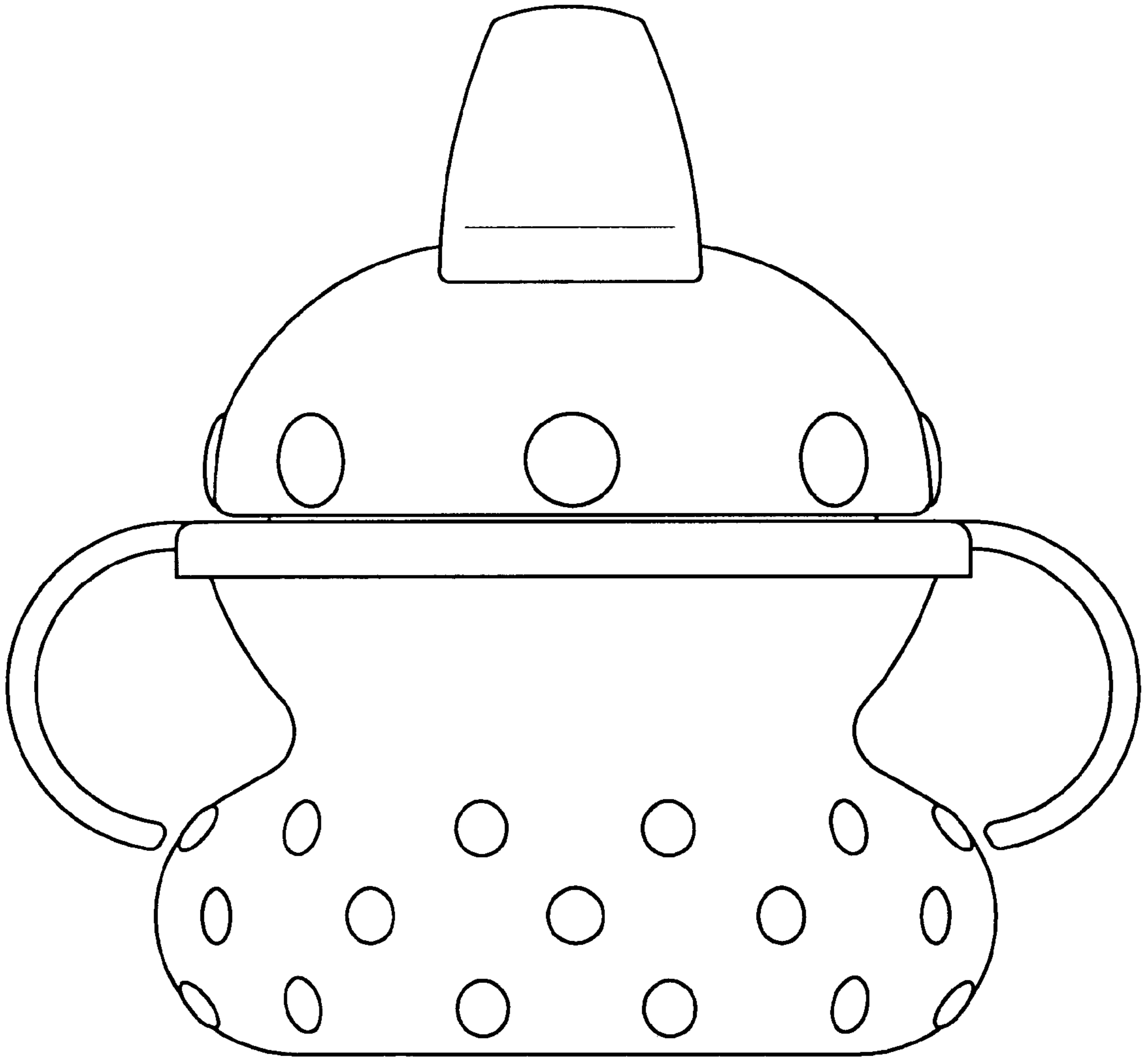

FIG. 3

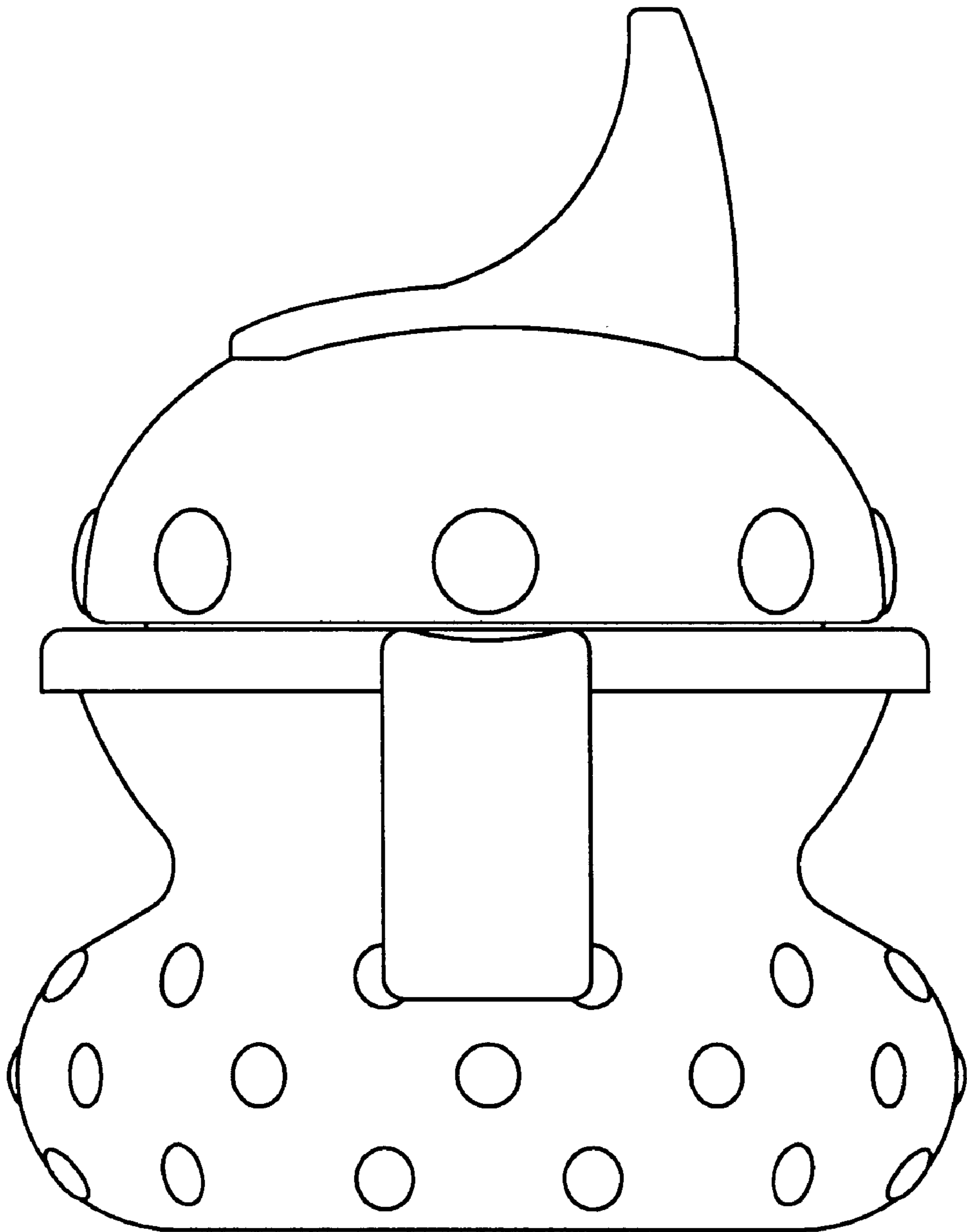

FIG. 4

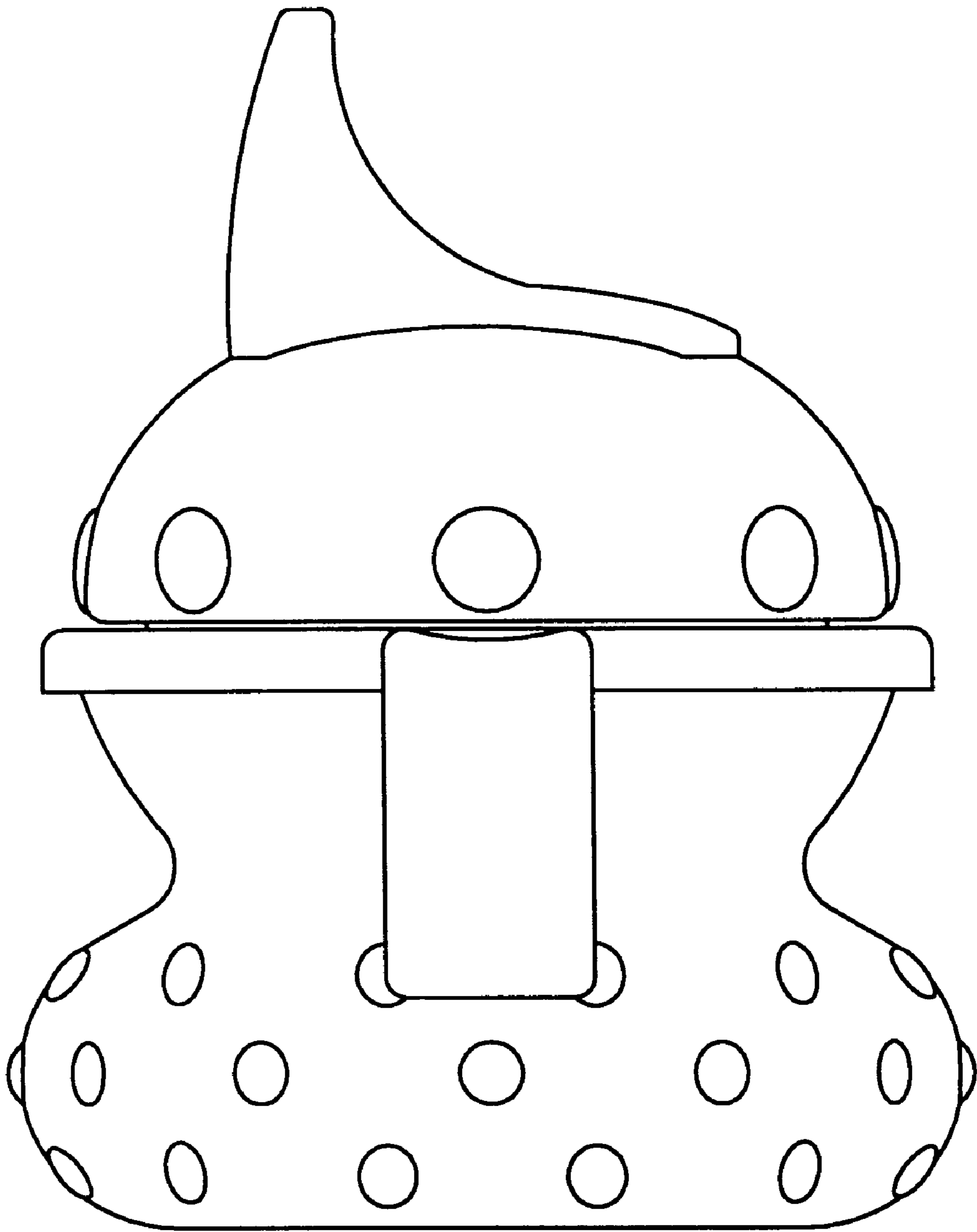

FIG. 5

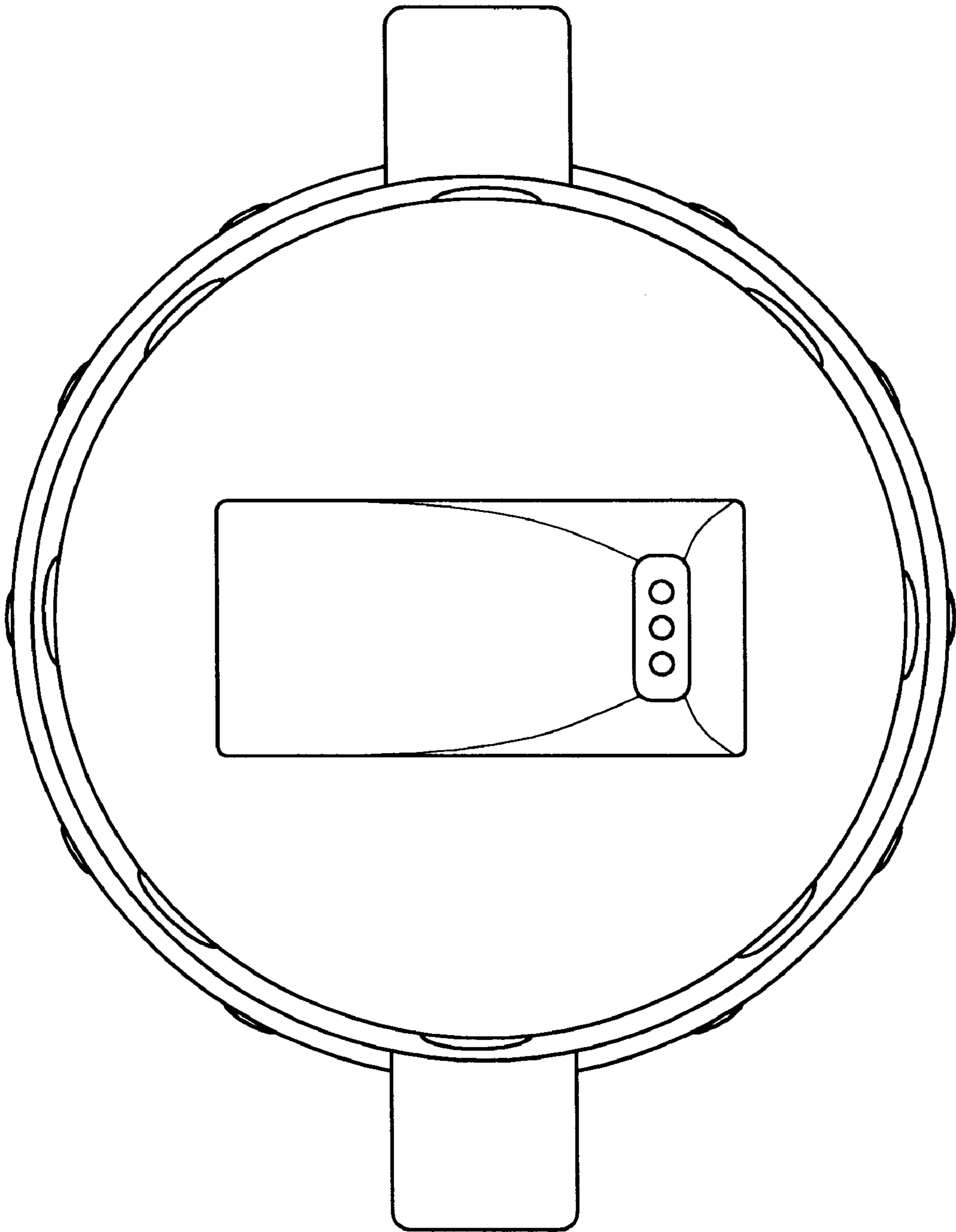

FIG. 6

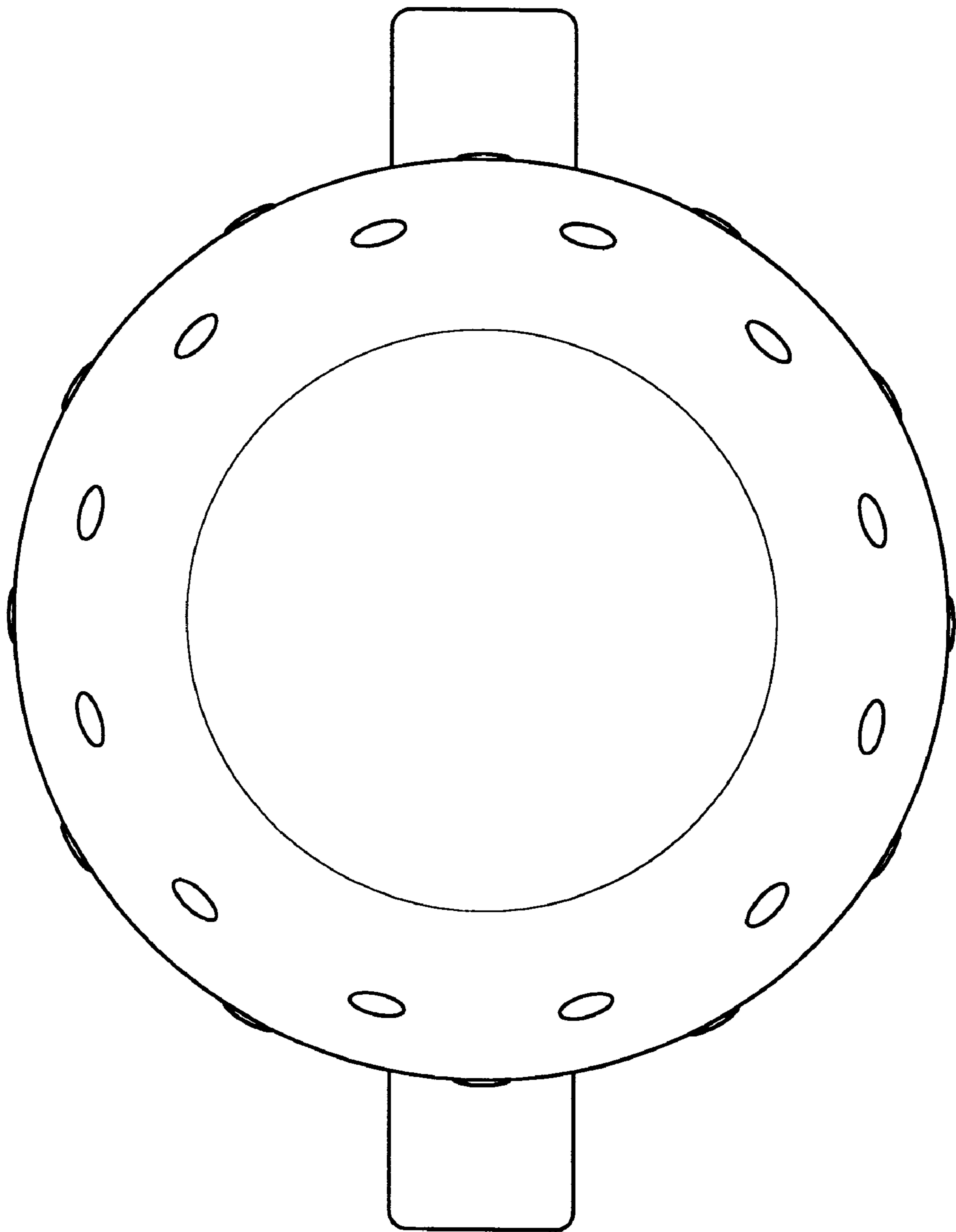

FIG. 7

UNITED STATES PATENT AND TRADEMARK OFFICE
CERTIFICATE OF CORRECTION

PATENT NO. : Des 421,878
DATED : March 28, 2000
INVENTOR(S) : Peter Roehrig

Page 1 of 1

It is certified that error appears in the above-identified patent and that said Letters Patent is hereby corrected as shown below:

Title page,

Below item [22], insert the following:

-- Item [30] **Foreign Application Priority Data**

Dec. 23, 1999 [AT] Austria...MU5433/98

Signed and Sealed this

Eighteenth Day of December, 2001

Attest:

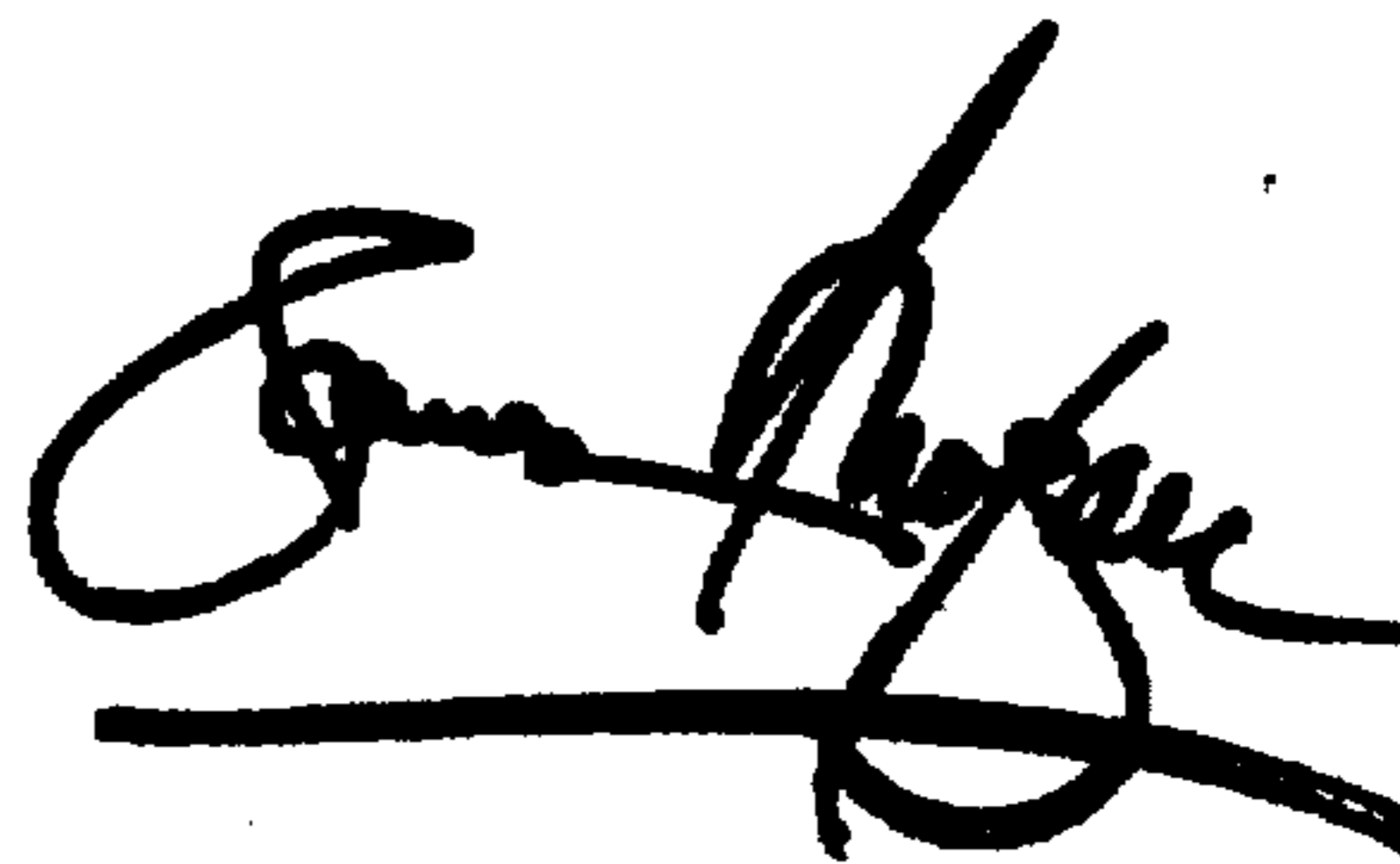

Attesting Officer

JAMES E. ROGAN
Director of the United States Patent and Trademark Office

UNITED STATES PATENT AND TRADEMARK OFFICE
CERTIFICATE OF CORRECTION

PATENT NO. : Des 421,878
DATED : March 28, 2000
INVENTOR(S) : Peter Roehrig

Page 1 of 1

It is certified that error appears in the above-identified patent and that said Letters Patent is hereby corrected as shown below:

Title page,

Below item [22], insert the following:

Item [30], **Foreign Application Priority Data**

Dec. 23, 1999 [AT] Austria...MU5433/98

Signed and Sealed this

Fifteenth Day of January, 2002

Attest:

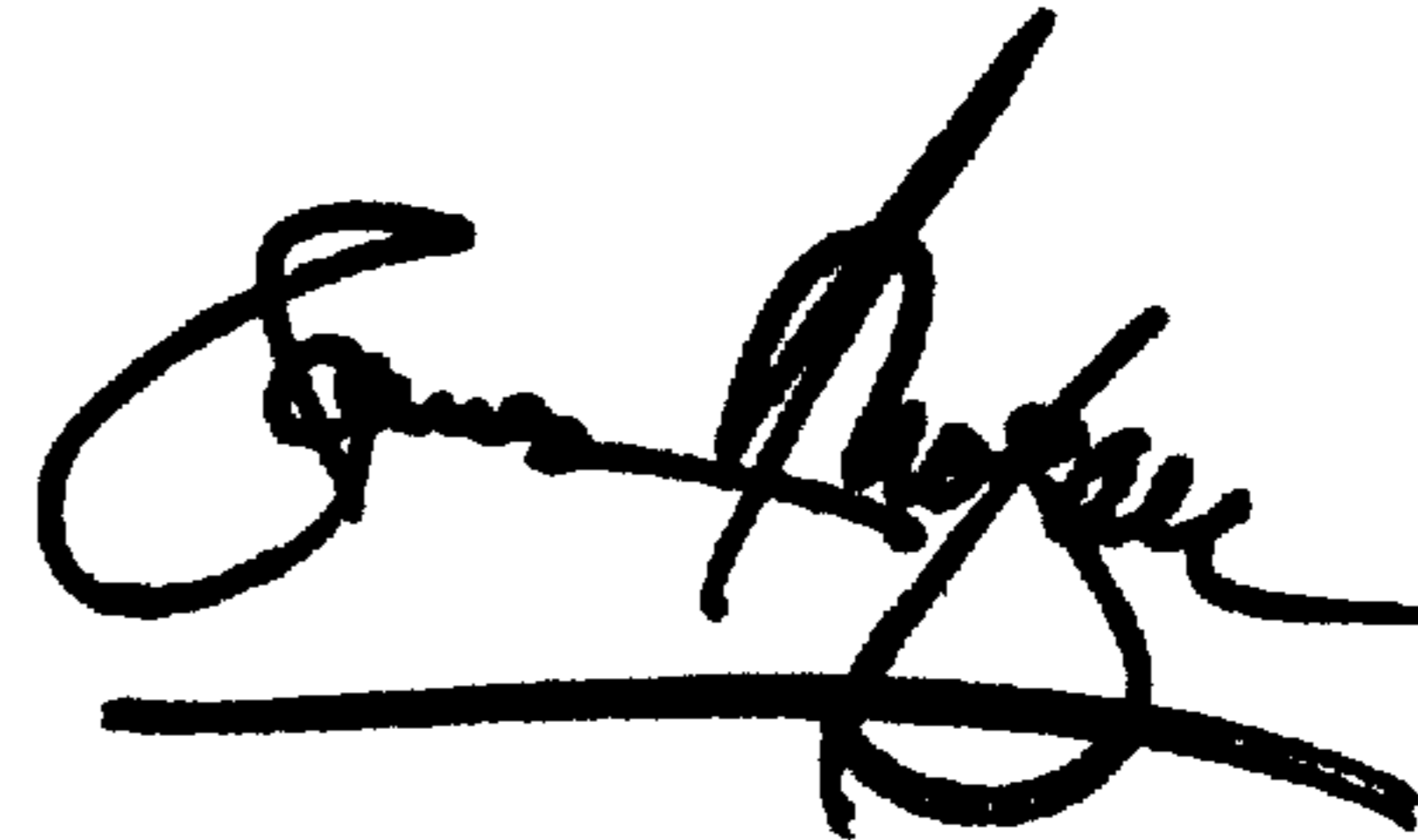

Attesting Officer

JAMES E. ROGAN
Director of the United States Patent and Trademark Office