



US00D421825S

**United States Patent** [19]  
**McColskey et al.**

[11] **Patent Number: Des. 421,825**

[45] **Date of Patent: \*\* Mar. 21, 2000**

[54] **CART**

D. 284,049 6/1986 Nathan et al. .... D6/408  
D. 386,871 11/1997 Halvorson, Jr. et al. .... D34/21

[75] Inventors: **Laura McColskey**, West Palm Beach;  
**Ryan Mimick**, Coral Springs; **Denise Tedaldi**, Jupiter, all of Fla.

*Primary Examiner*—Kay H. Chin  
*Attorney, Agent, or Firm*—Quarles & Brady LLP

[73] Assignee: **Levenger Company**, Delray Beach, Fla.

[57] **CLAIM**

The ornamental design for a cart, as shown and described.

[\*\*] Term: **14 Years**

**DESCRIPTION**

[21] Appl. No.: **29/105,427**

FIG. 1 is a perspective view of a cart showing our new design;

[22] Filed: **May 25, 1999**

FIG. 2 is a right side elevation view;

[51] **LOC (6) Cl.** ..... **12-02**

FIG. 3 is a left side elevation view;

[52] **U.S. Cl.** ..... **D34/24; D34/12**

FIG. 4 is a front elevation view;

[58] **Field of Search** ..... D34/12-27; D6/473,  
D6/476, 478, 479; 280/47.19, 47.24, 652,  
47.17; 211/59.2

FIG. 5 is a rear elevation view;

FIG. 6 is a top plan view; and,

FIG. 7 is a bottom plan view thereof.

[56] **References Cited**

**U.S. PATENT DOCUMENTS**

D. 280,771 9/1985 Barnett ..... D34/22

**1 Claim, 2 Drawing Sheets**

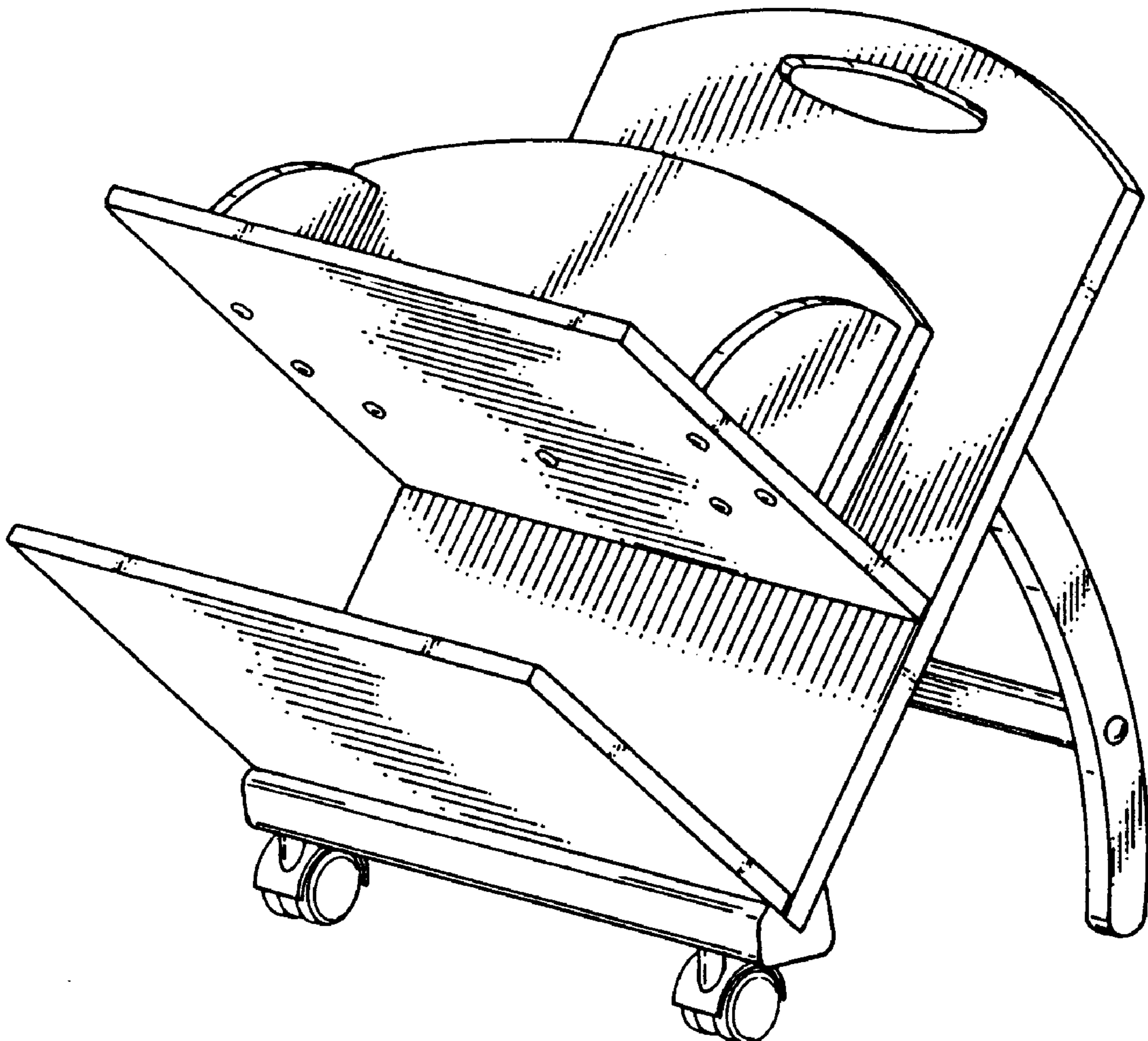

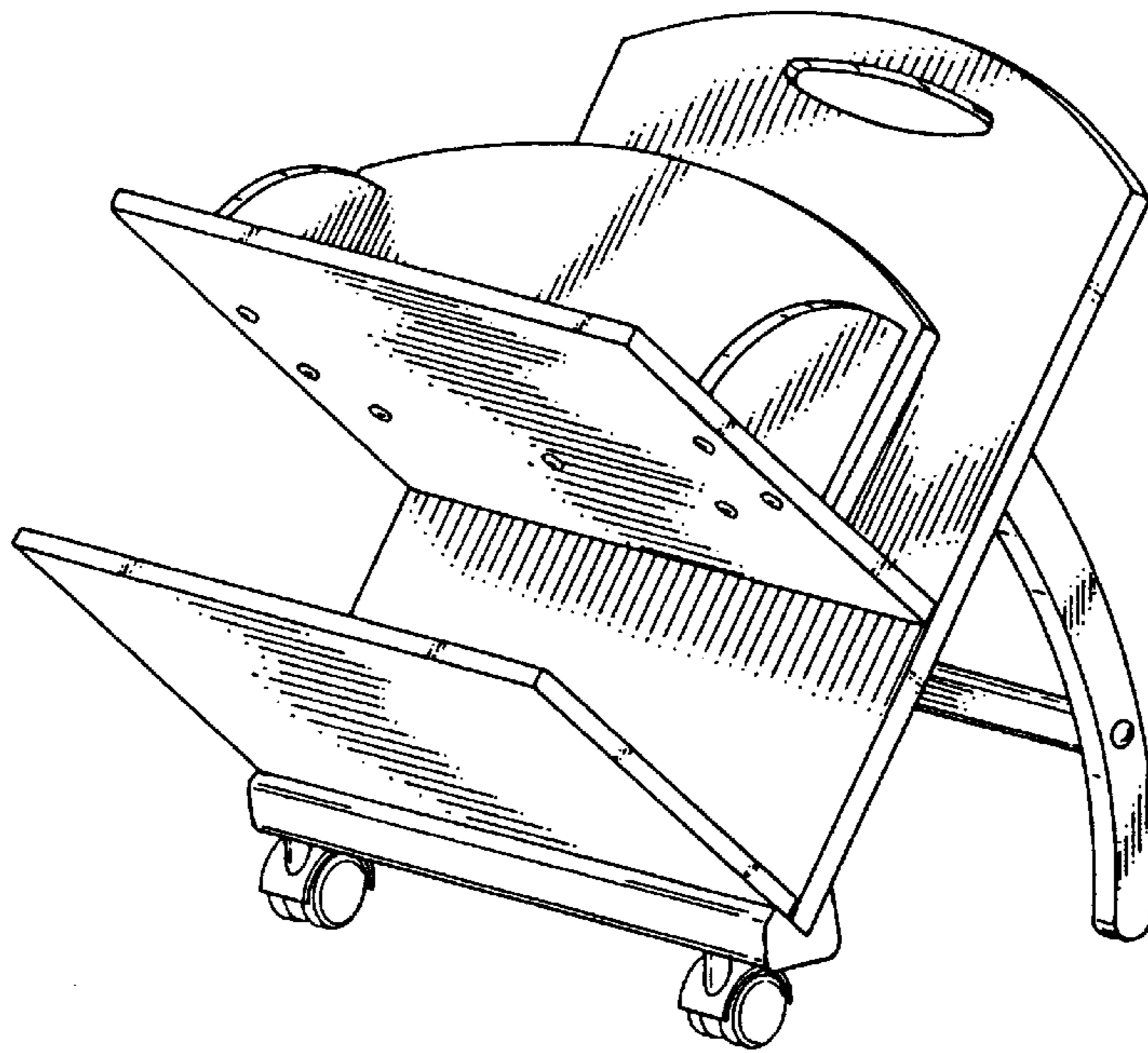

FIG. 1

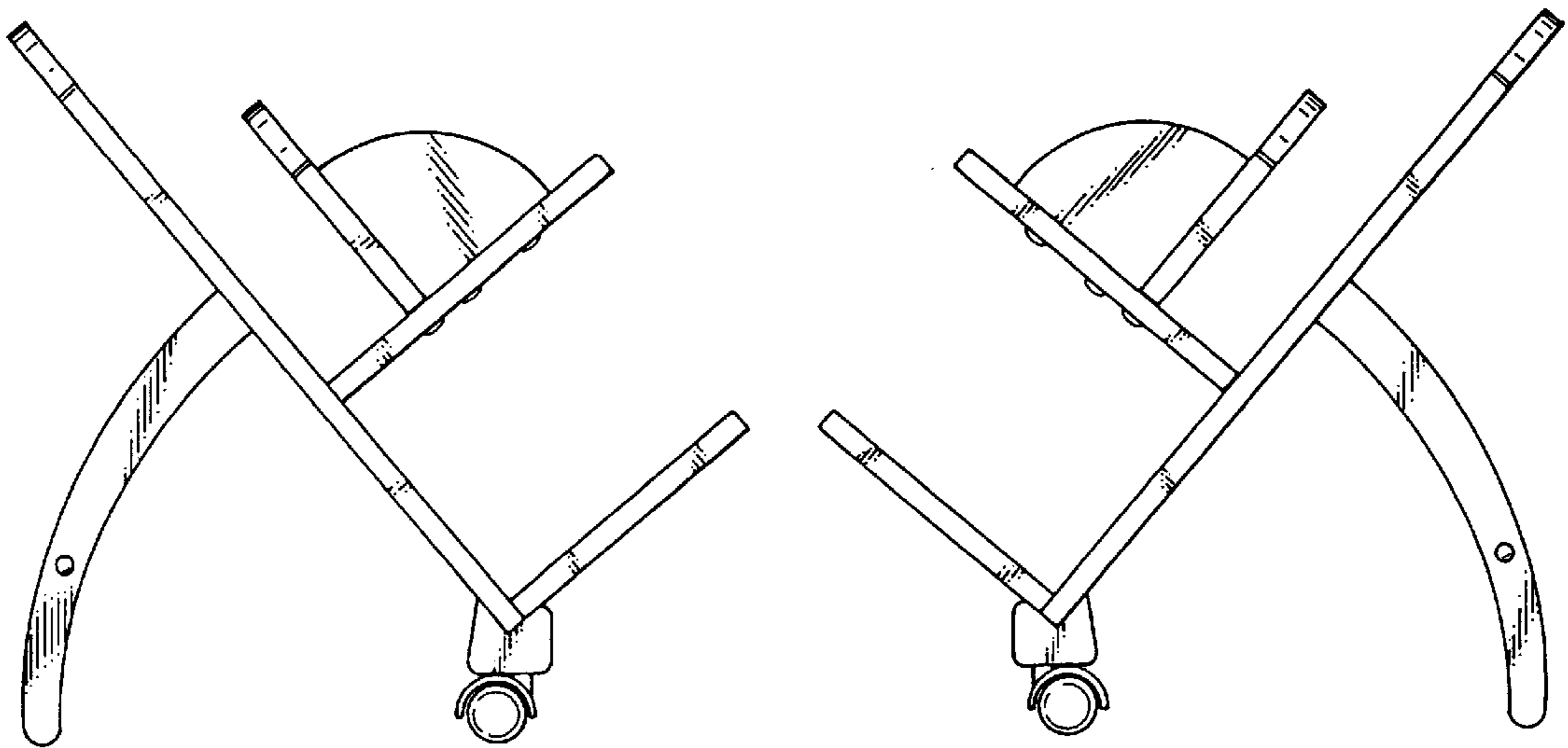

FIG. 2

FIG. 3

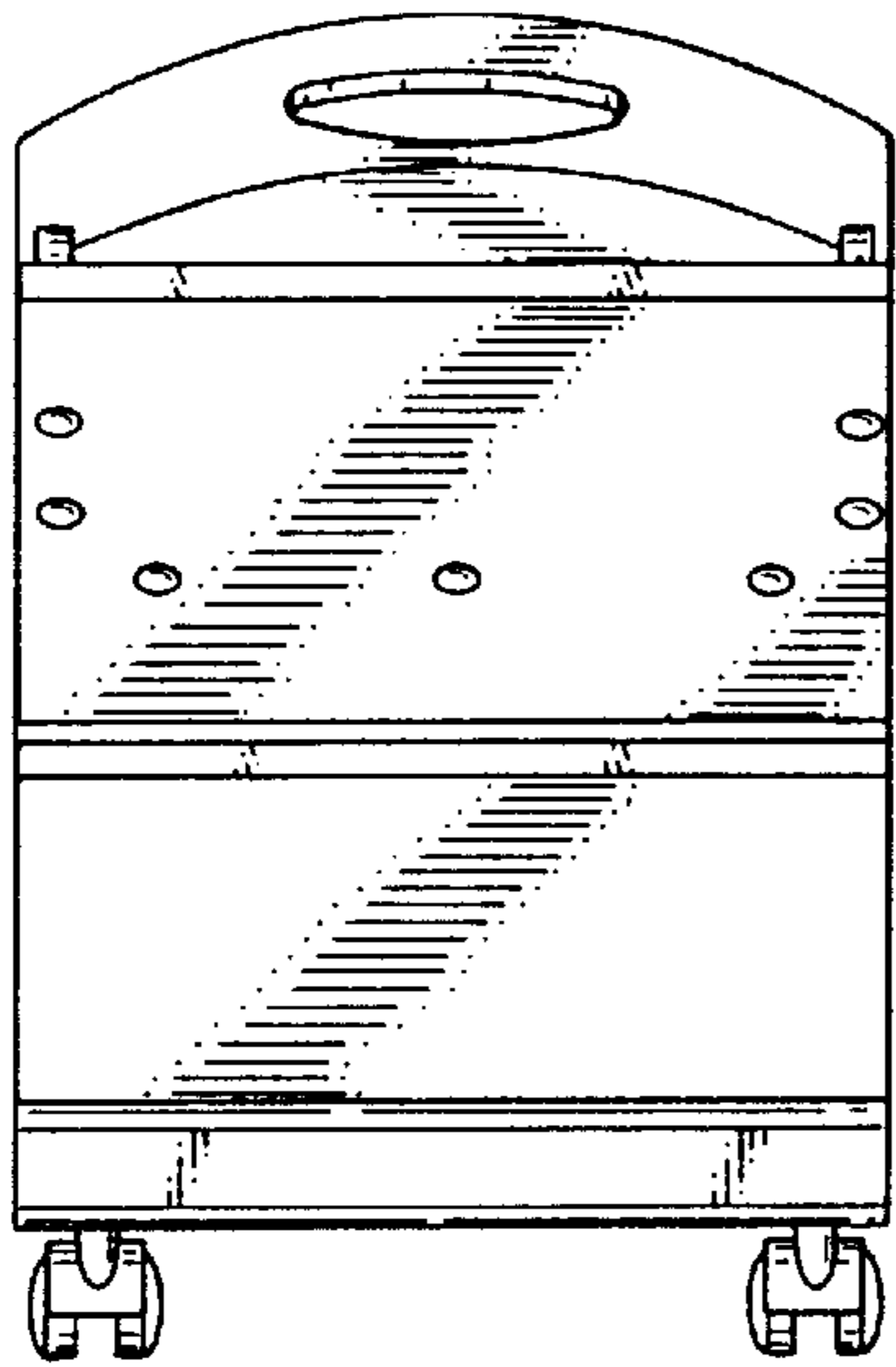

FIG. 4

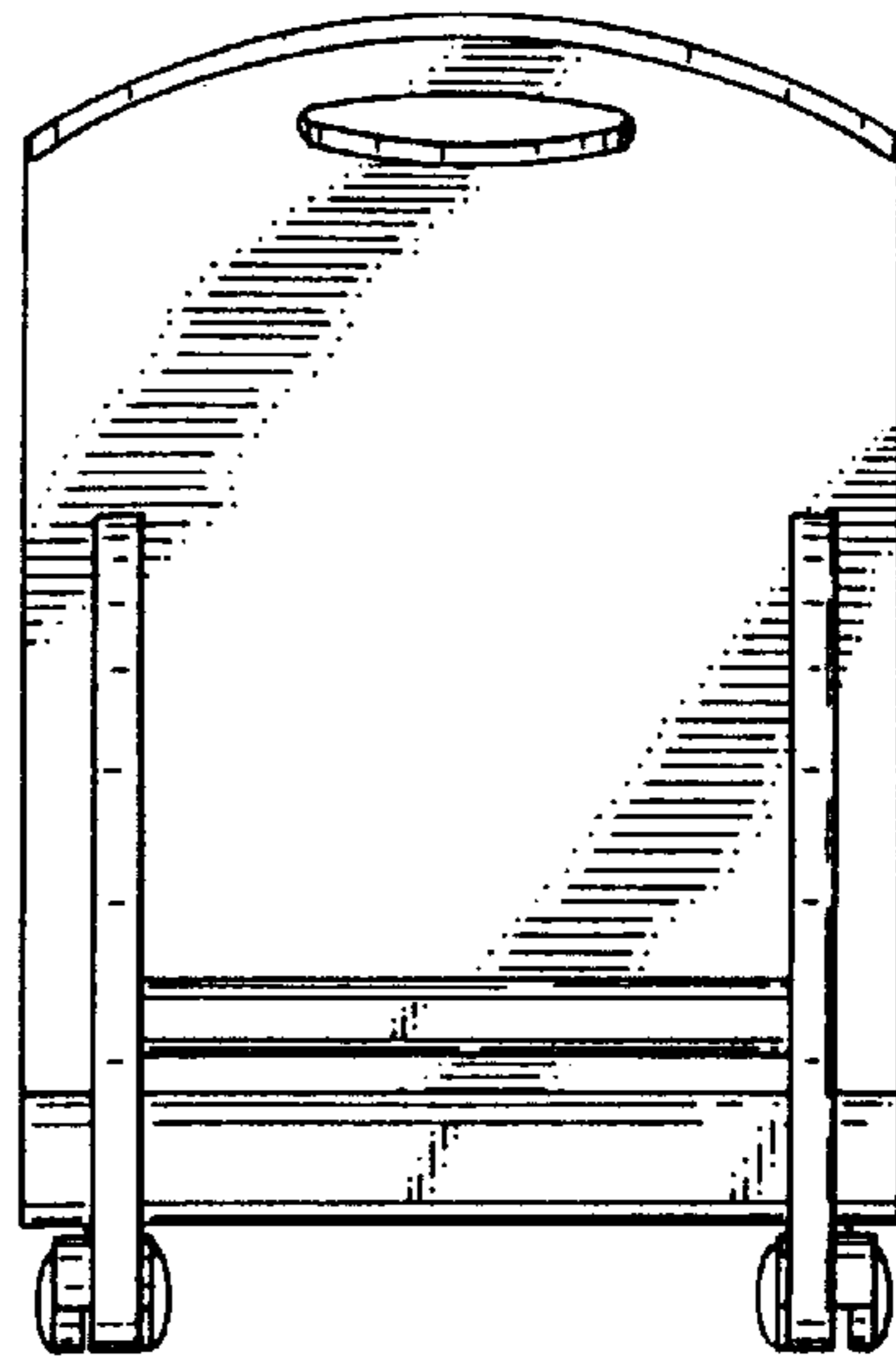

FIG. 5

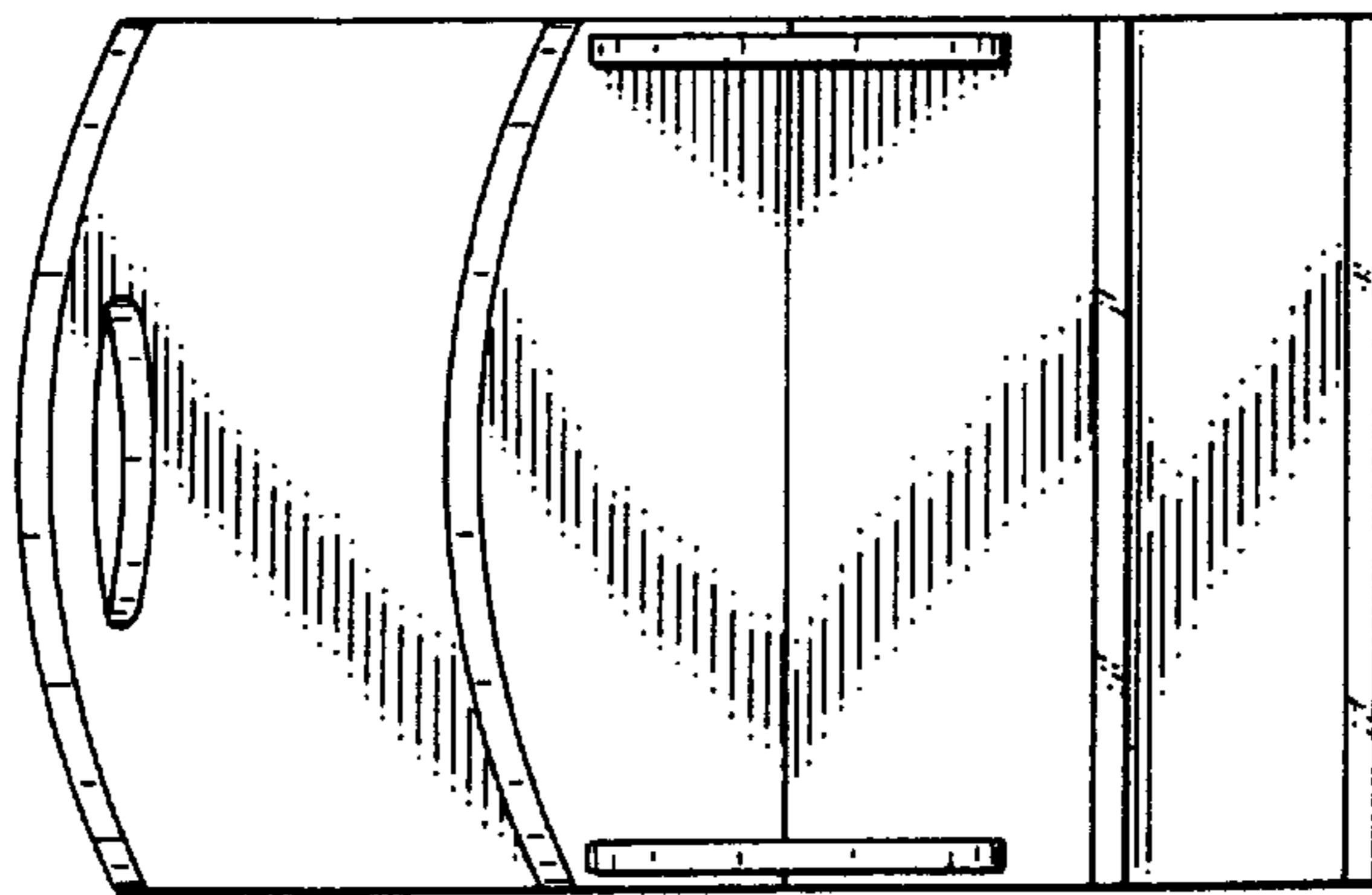

FIG. 6

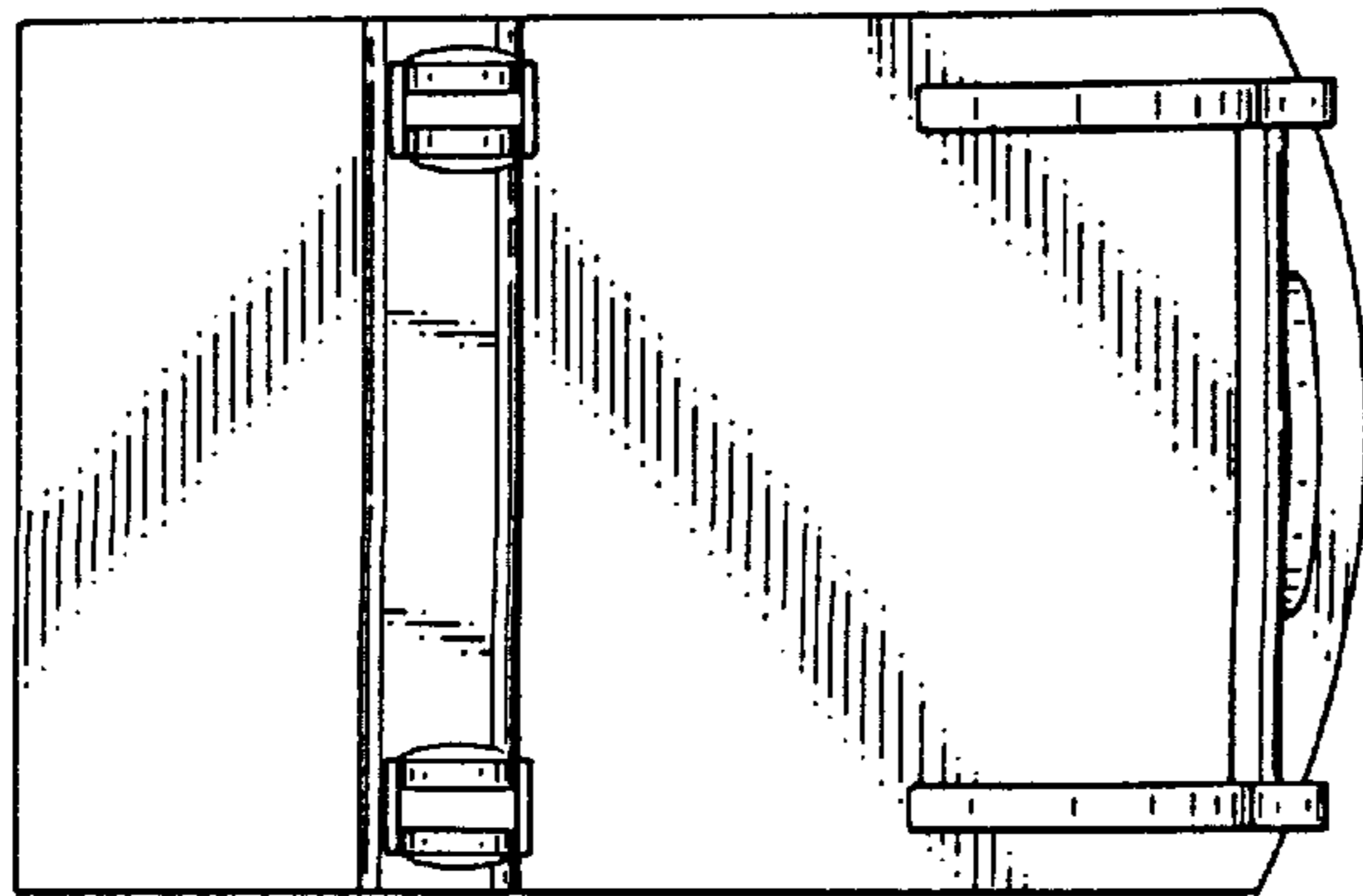

FIG. 7