



US00D421747S

United States Patent [19]
Takizawa

[11] **Patent Number: Des. 421,747**
[45] **Date of Patent: ** Mar. 21, 2000**

[54] **IMAGE DISPLAY APPARATUS**

D. 354,949 1/1995 Yao D14/100

[75] Inventor: **Sakiko Takizawa**, Kawasaki, Japan

Primary Examiner—Freda Nunn
Attorney, Agent, or Firm—Fitzpatrick, Cella, Harper & Scinto

[73] Assignee: **Canon Kabushiki Kaisha**, Tokyo, Japan

[**] Term: **14 Years**

[57] **CLAIM**

[21] Appl. No.: **29/099,418**

The ornamental design for an image display apparatus, as shown and described.

[22] Filed: **Jan. 21, 1999**

DESCRIPTION

[30] **Foreign Application Priority Data**

Jul. 22, 1998 [JP] Japan 10-021003

FIG. 1 is a front view of an image display apparatus showing my new design;

[51] **LOC (6) Cl.** **14-02**

FIG. 2 is a rear view thereof;

[52] **U.S. Cl.** **D14/113; D14/126**

FIG. 3 is a top plan view thereof;

[58] **Field of Search** D14/100, 101, D14/113, 124-129; 248/918-924; 341/12; 348/180, 184, 325, 739; 345/104, 133, 156, 168, 87, 173; 349/1, 2, 11, 62

FIG. 4 is a bottom plan view thereof;

FIG. 5 is a left side view thereof;

FIG. 6 is a right side view thereof; and,

FIG. 7 is a perspective view thereof.

[56] **References Cited**

U.S. PATENT DOCUMENTS

D. 348,657 7/1994 Matsuda D14/113

1 Claim, 6 Drawing Sheets

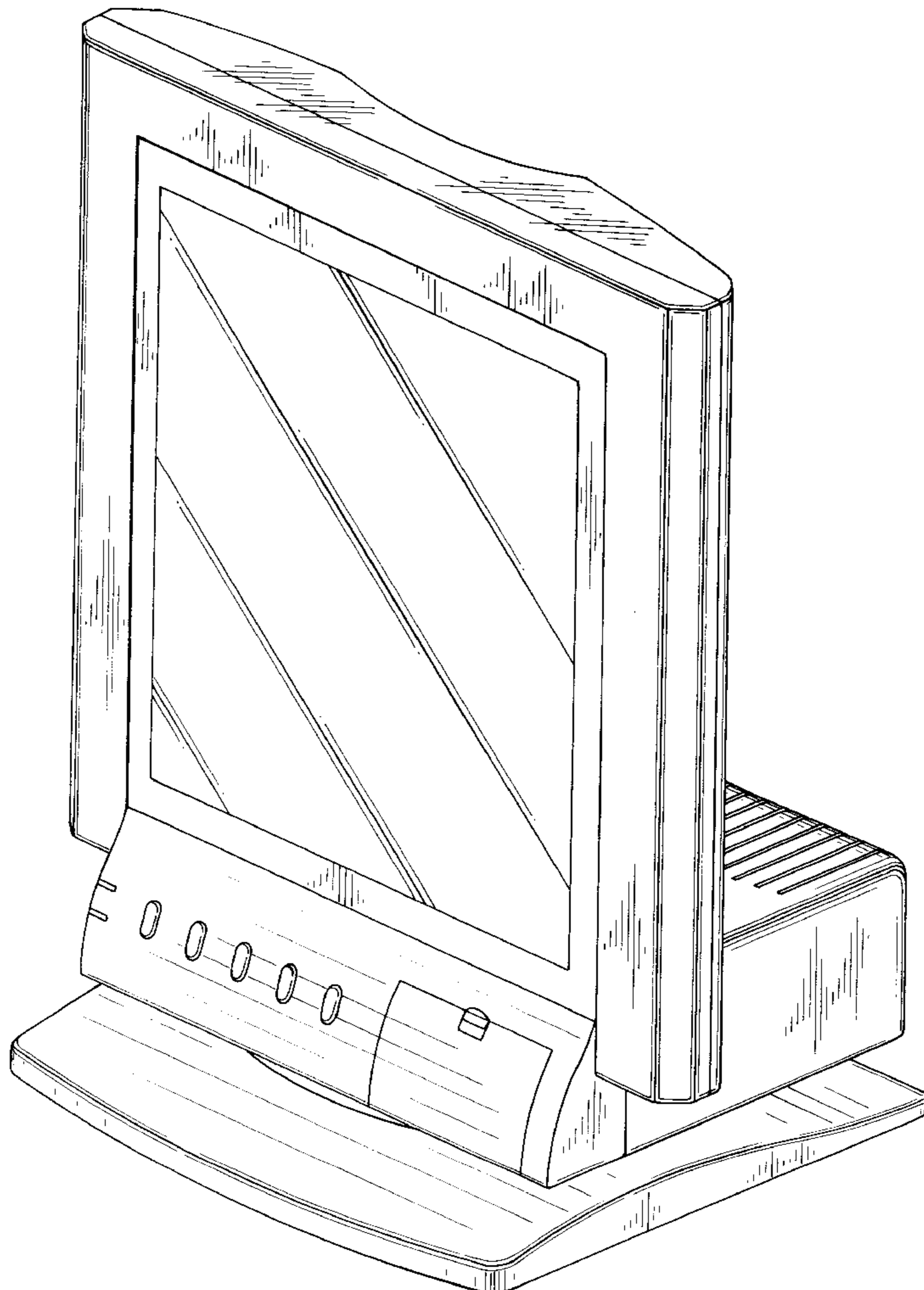

FIG. 1

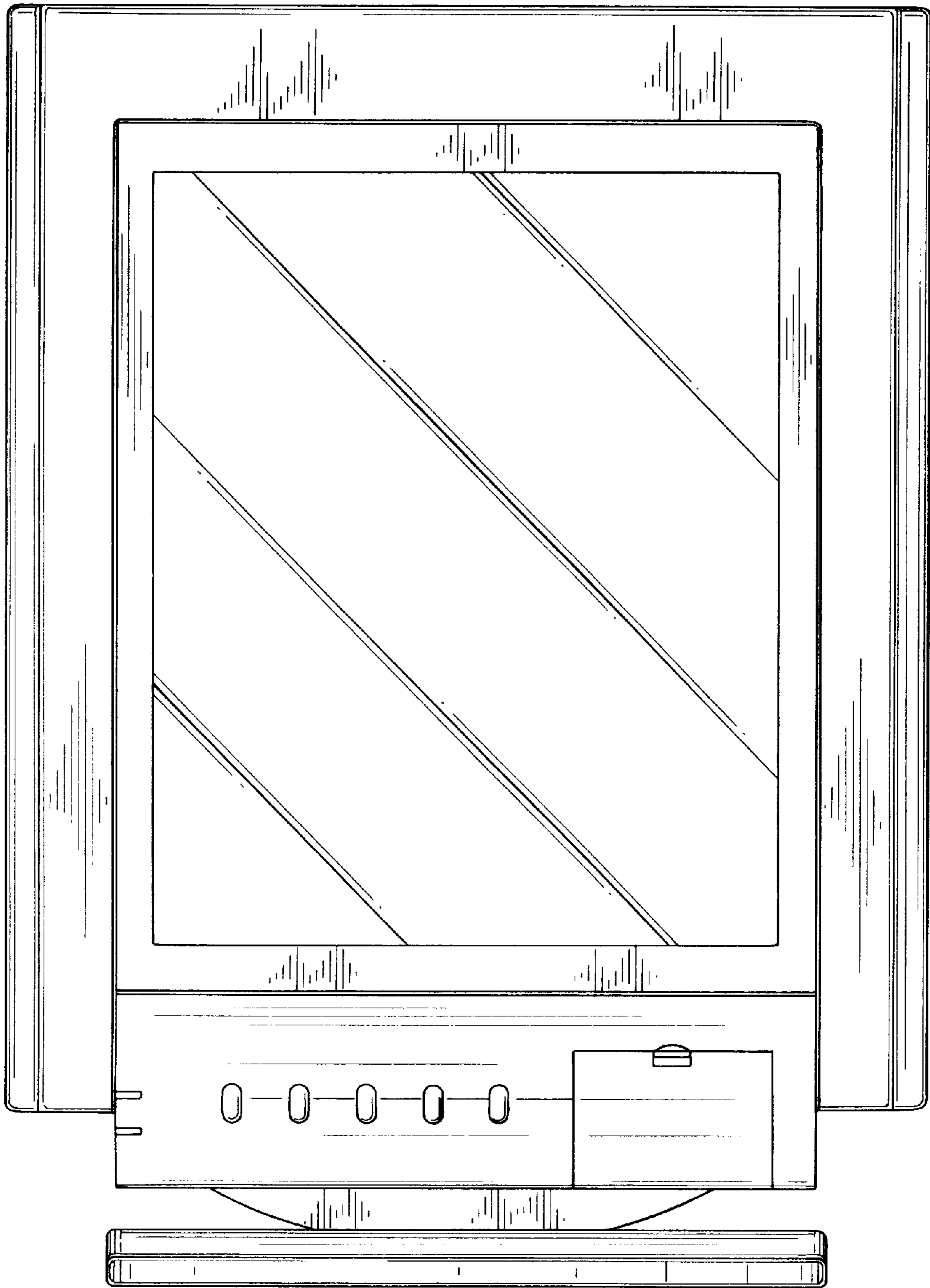

FIG. 2

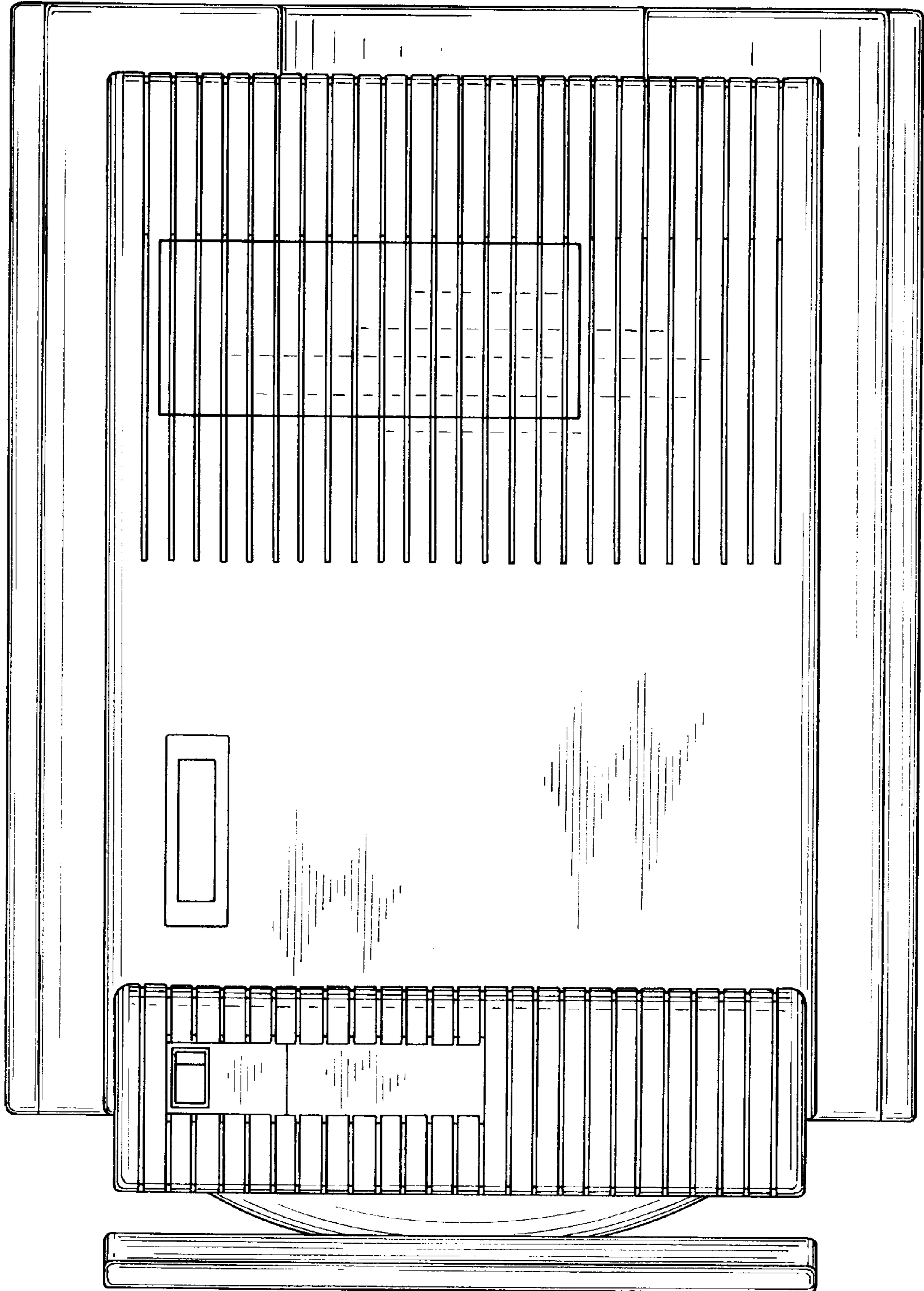

FIG. 3

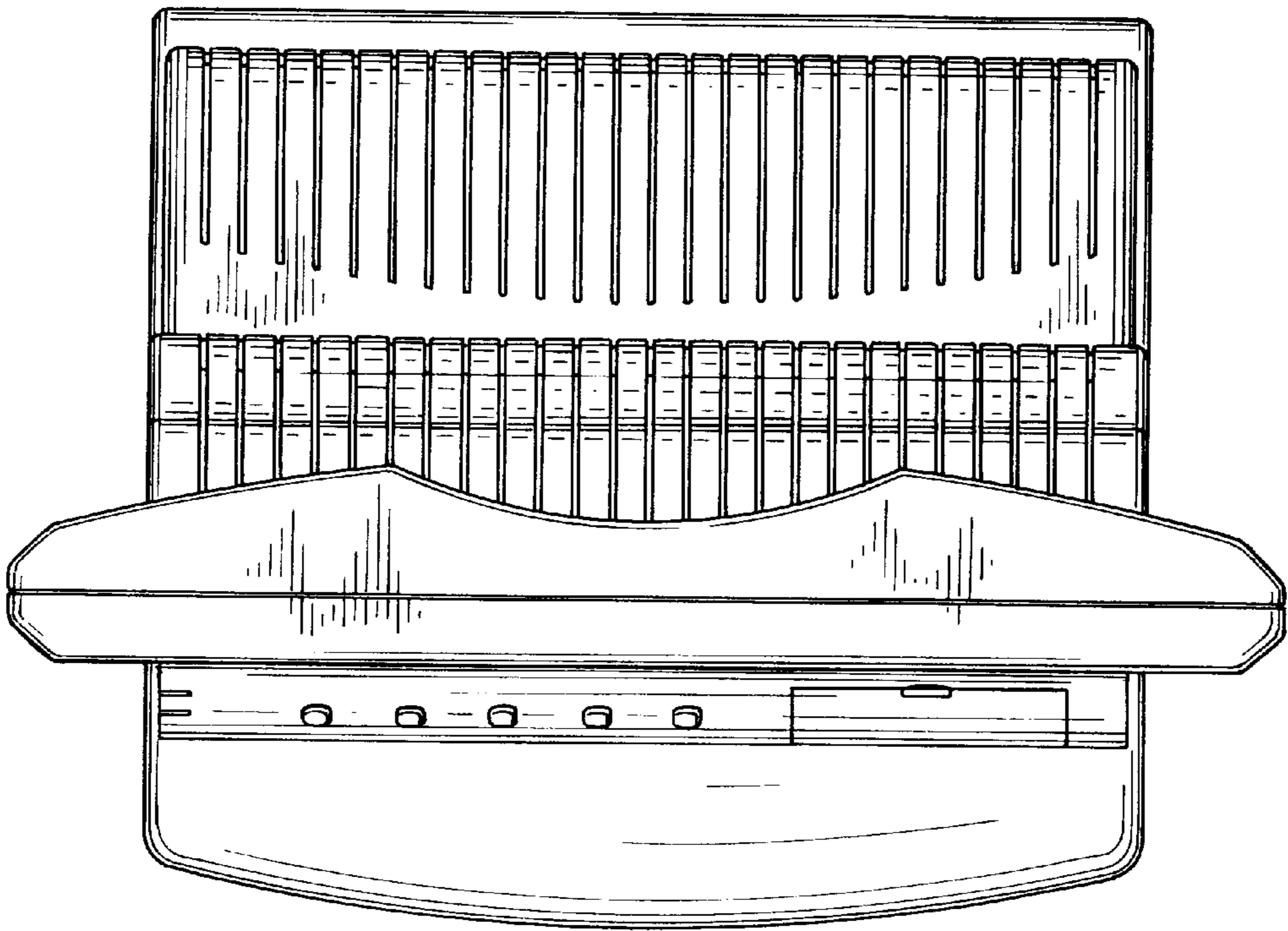

FIG. 4

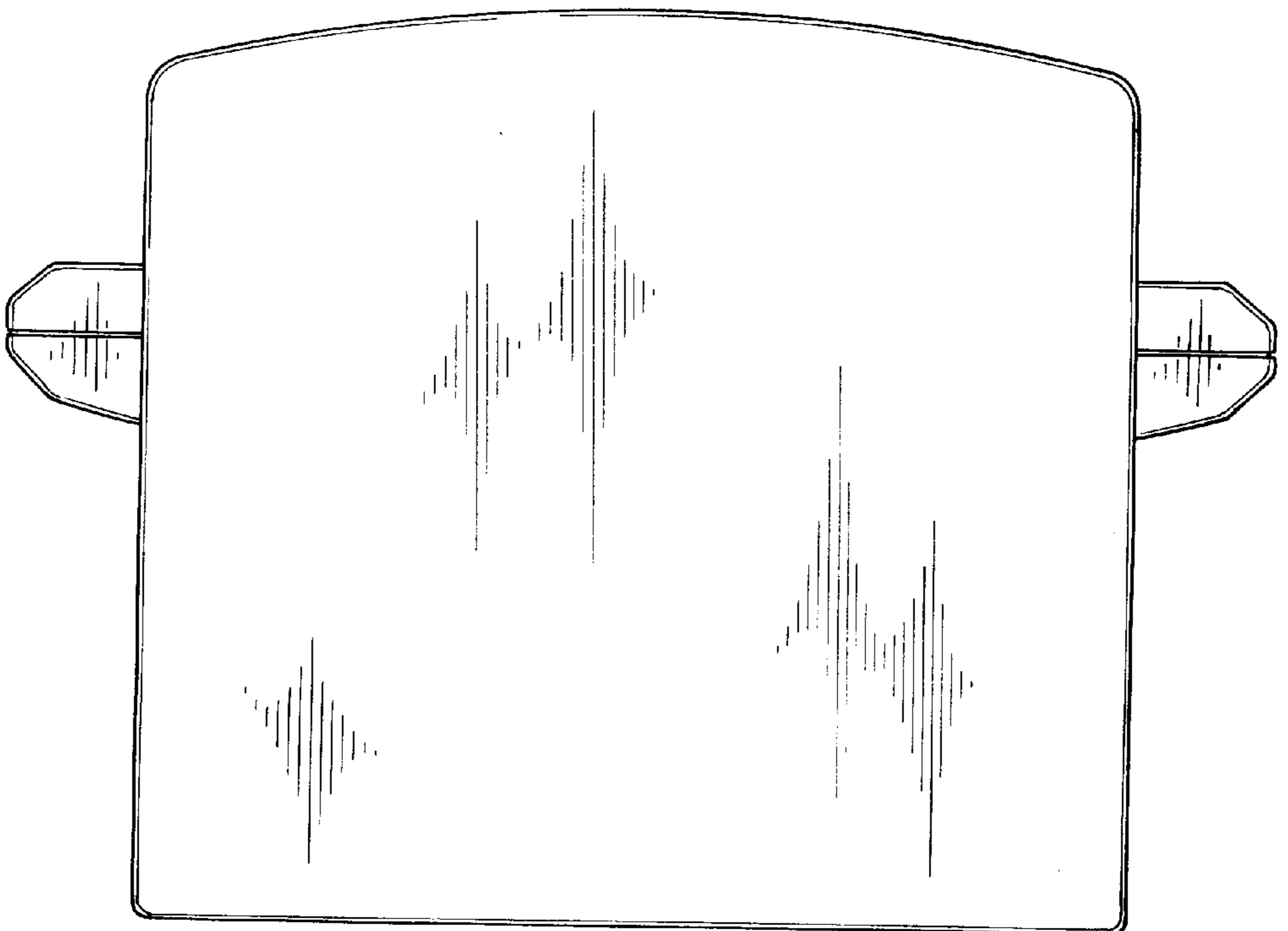

FIG. 5

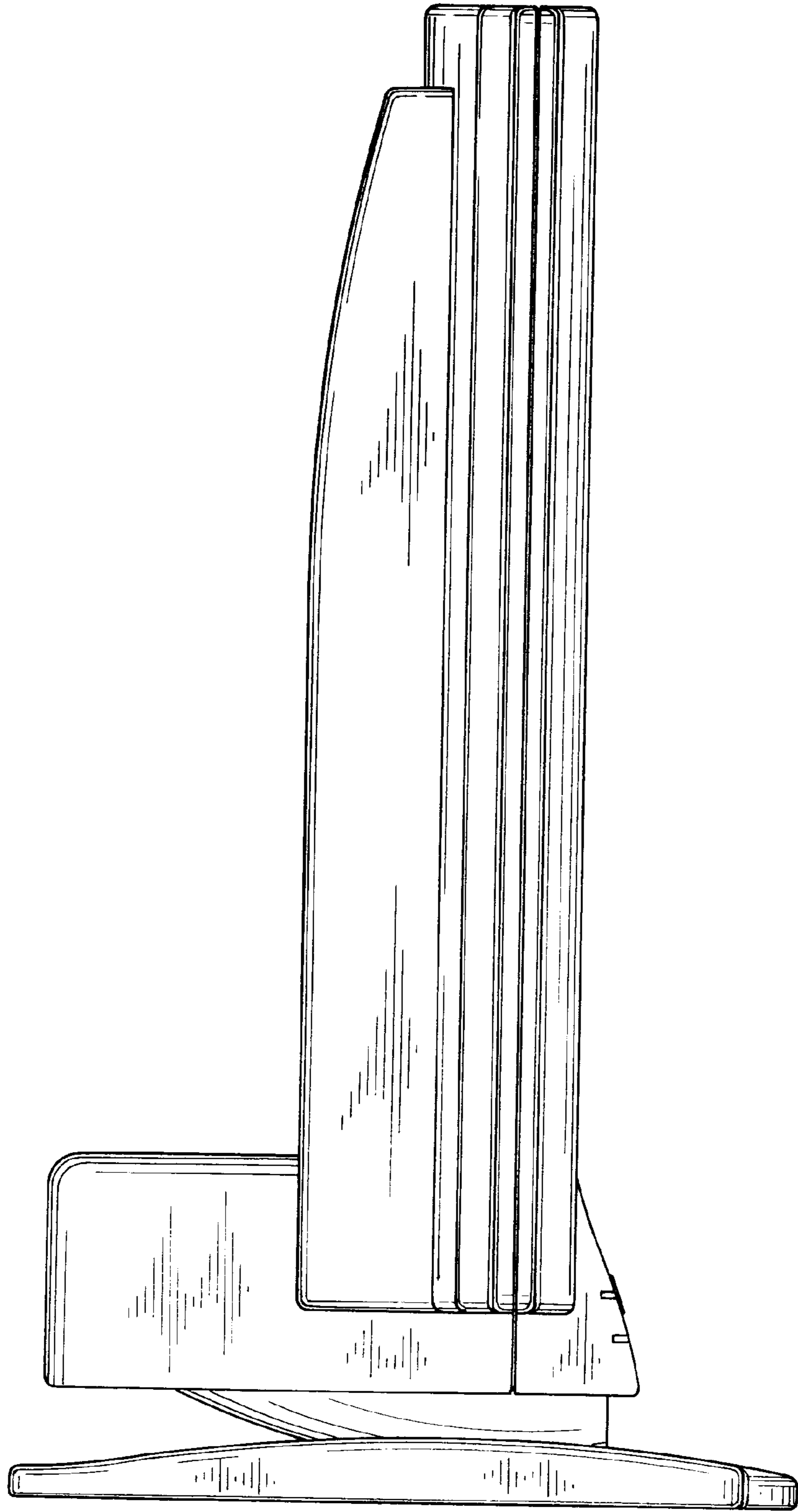

FIG. 6

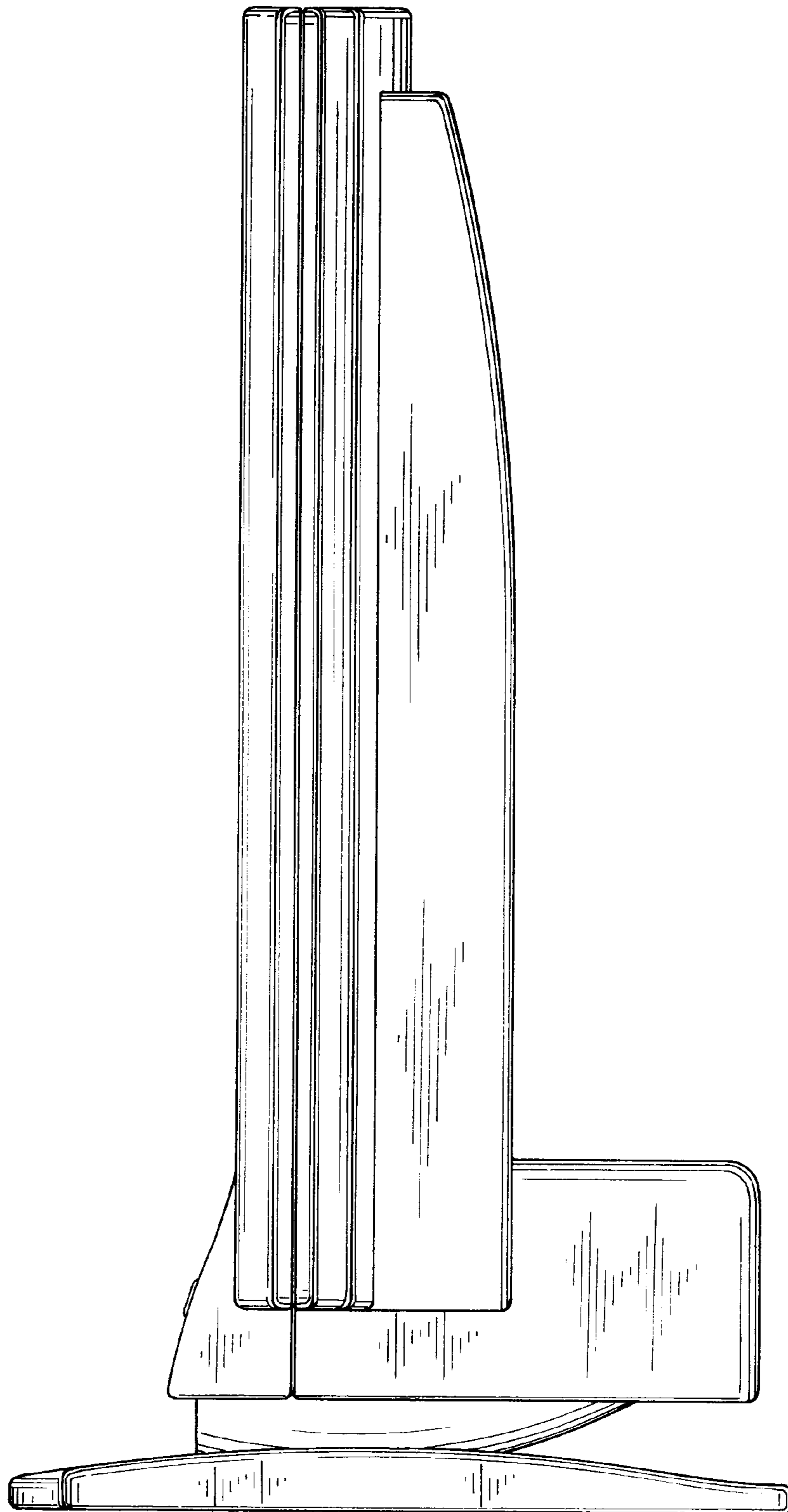

FIG. 7

