



US00D421720S

United States Patent [19]

[11] **Patent Number: Des. 421,720**

Eberle et al.

[45] **Date of Patent: ** Mar. 21, 2000**

[54] **CONTAINER**

[75] Inventors: **Theodore F. Eberle**, Chicago; **Jizu J. Cheng**, Burr Ridge; **Richard G. Kraft**, Joilet, all of Ill.; **Charles M. Brandt**, Lithia Springs, Ga.

[73] Assignee: **Crown Cork & Seal Technologies Corporation**, Alsip, Ill.

[**] Term: **14 Years**

[21] Appl. No.: **29/087,361**

[22] Filed: **May 1, 1998**

[51] **LOC (6) Cl. 09-01**

[52] **U.S. Cl. D9/500; D9/434; D9/502; D9/538**

[58] **Field of Search D9/500, 502, 503, D9/538-540, 545, 557, 434, 559; 215/370-384**

beverage container (brand unknown —approximately 64 to 68 oz).

Veryfine® Apple Quenchers™ 46 Fl.oz beverage container (brand unknown —approximately 46 oz).

beverage container (brand unknown —approximately 46 oz).

Everfresh® beverage container (approximately 32 oz).

Gatorade® beverage container (approximately 32 oz).

ā™ beverage container (approximately 20 oz).

beverage container (manufactured possibly Graham Packaging, approximately 20 oz).

Veryfine® beverage container (approximately 20 oz).

Primary Examiner—Lucy Lieberman
Attorney, Agent, or Firm—Woodcock Washburn Kurtz Mackiewicz & Norris LLP

[56] **References Cited**

U.S. PATENT DOCUMENTS

D. 57,979	5/1921	King	D9/571
D. 204,325	4/1966	Myers	D9/571
D. 226,169	1/1973	Bielicki	D9/571
D. 241,713	10/1976	Plummer	D9/500
D. 241,715	10/1996	Plummer	D9/500
D. 294,118	2/1988	Papa	D9/538
D. 315,869	4/1991	Collette	D9/538
D. 316,966	5/1991	York	D9/500
D. 316,968	5/1991	York	D9/538
D. 345,693	4/1994	Edstrom	D9/538
D. 366,416	1/1996	Semersky	D9/434
4,877,141	10/1989	Hayashi et al.	D9/538
5,341,946	8/1994	Vaillencourt et al.	215/381
5,407,086	4/1995	Ota et al.	215/383
5,704,503	1/1998	Krishnakumar et al.	215/381

OTHER PUBLICATIONS

Powerade™ beverage container (approximately 20 oz).
ā™ beverage container (approximately 64 to 68 oz).
beverage container (brand unknown —approximately 64 to 68 oz).

[57] **CLAIM**

An ornamental design for a container, as shown and described.

DESCRIPTION

FIG. 1 is a perspective view of a container showing our new design;

FIG. 2 is a front elevation thereof, the rear elevation is the same;

FIG. 3 is a right side elevation thereof, the left side elevation is the same;

FIG. 4 is a top plan view; and,

FIG. 5 is a bottom plan view.

Any broken lines in the drawings are in the views for illustrative purposes only and form no part of the claimed design.

1 Claim, 4 Drawing Sheets

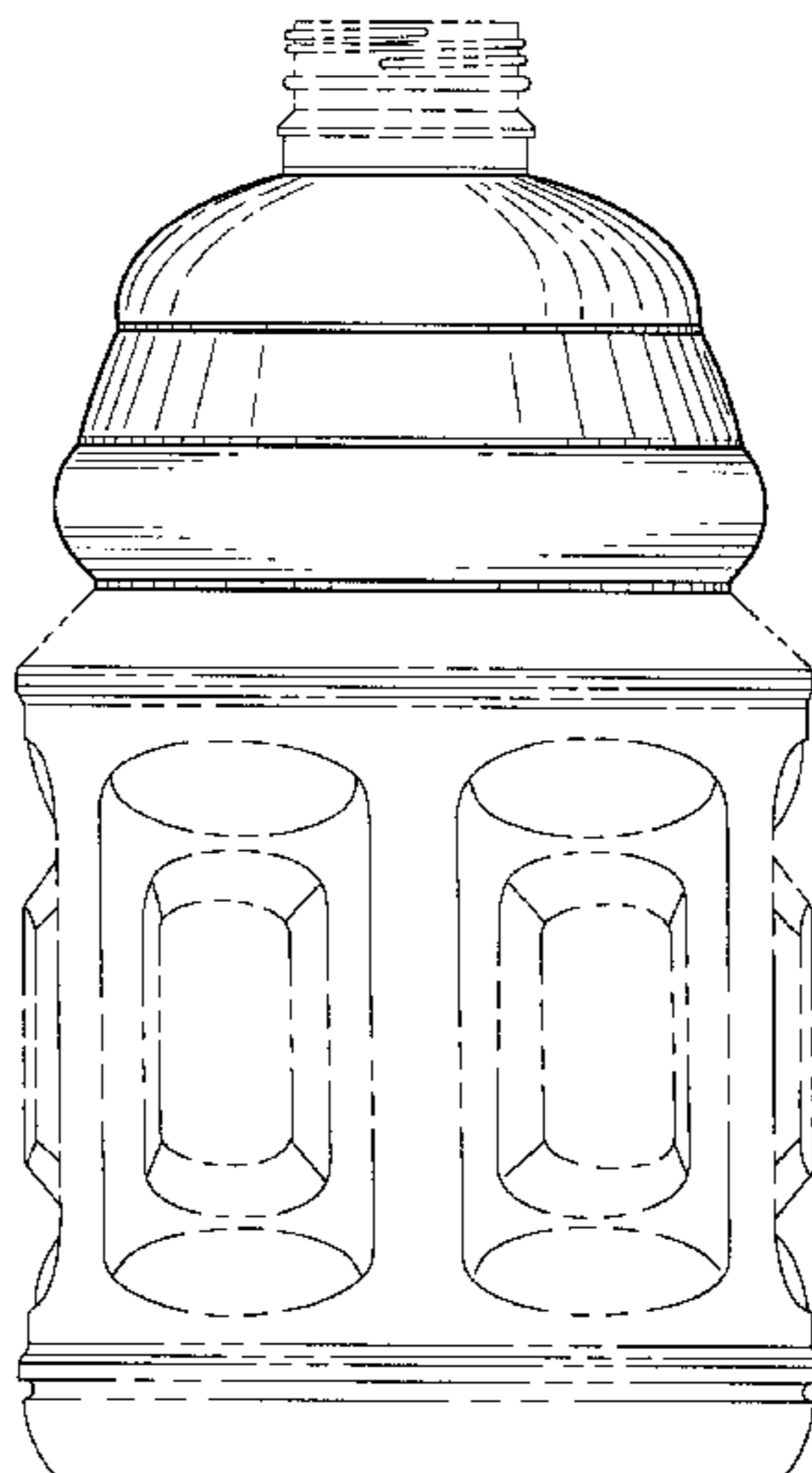

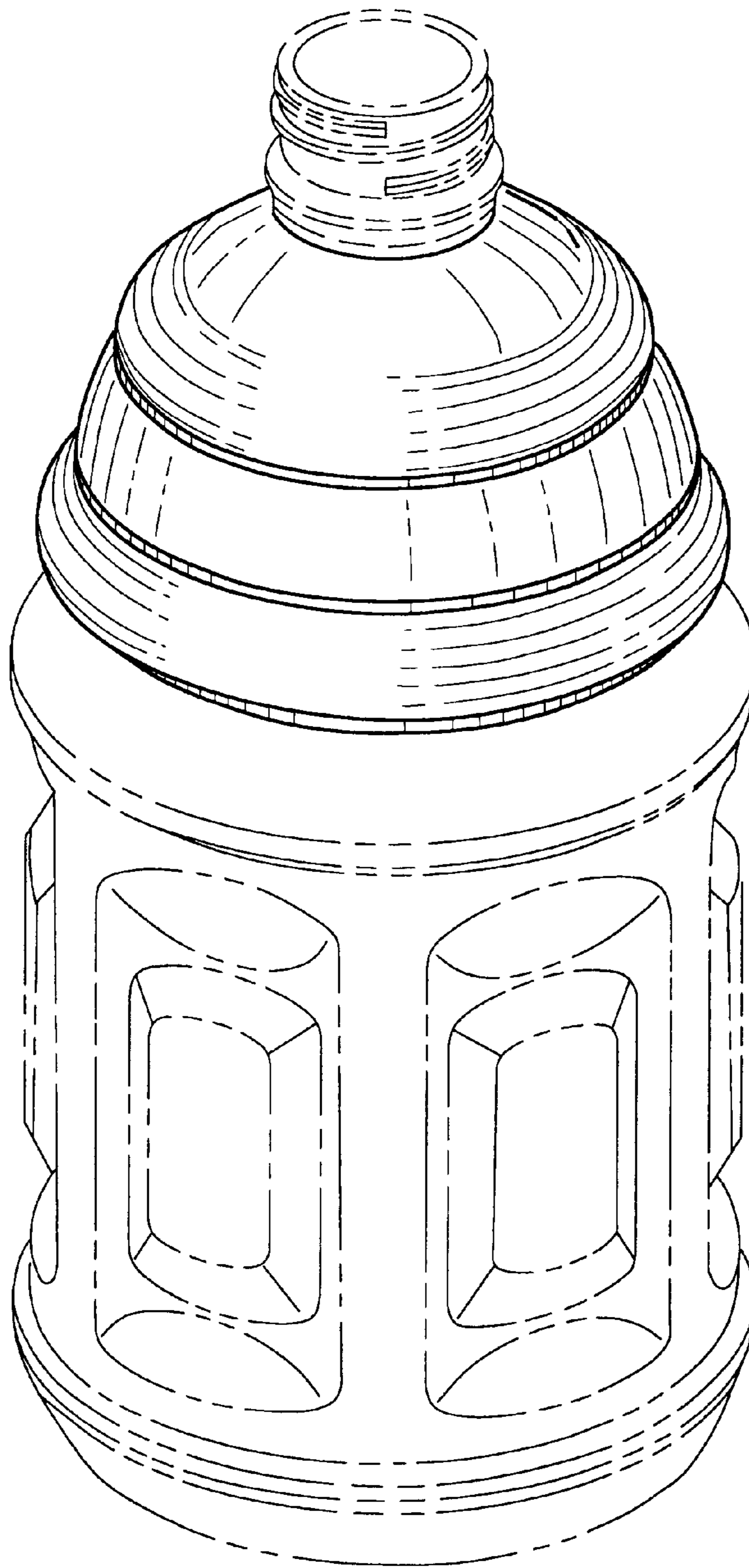

FIG. 1

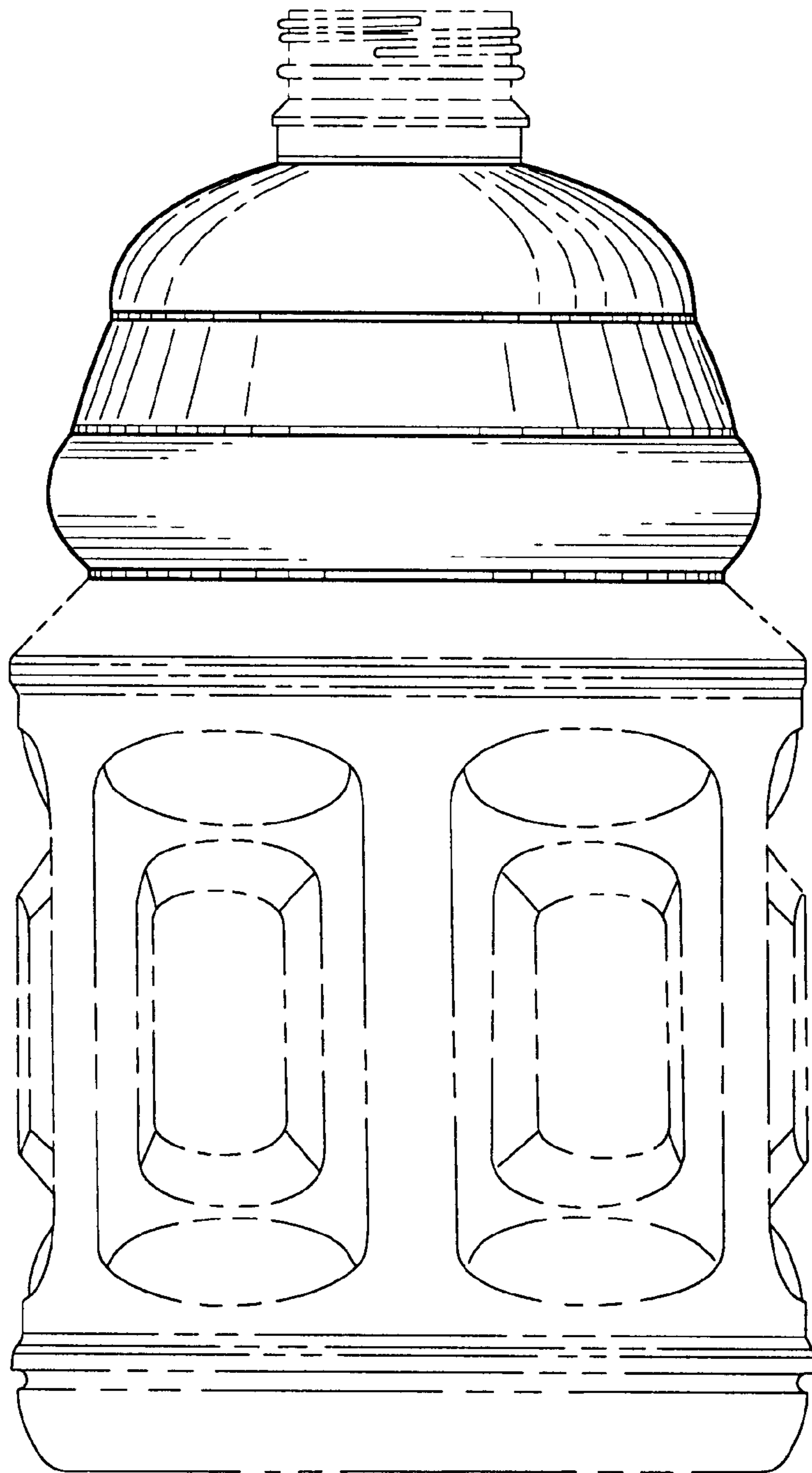

FIG. 2

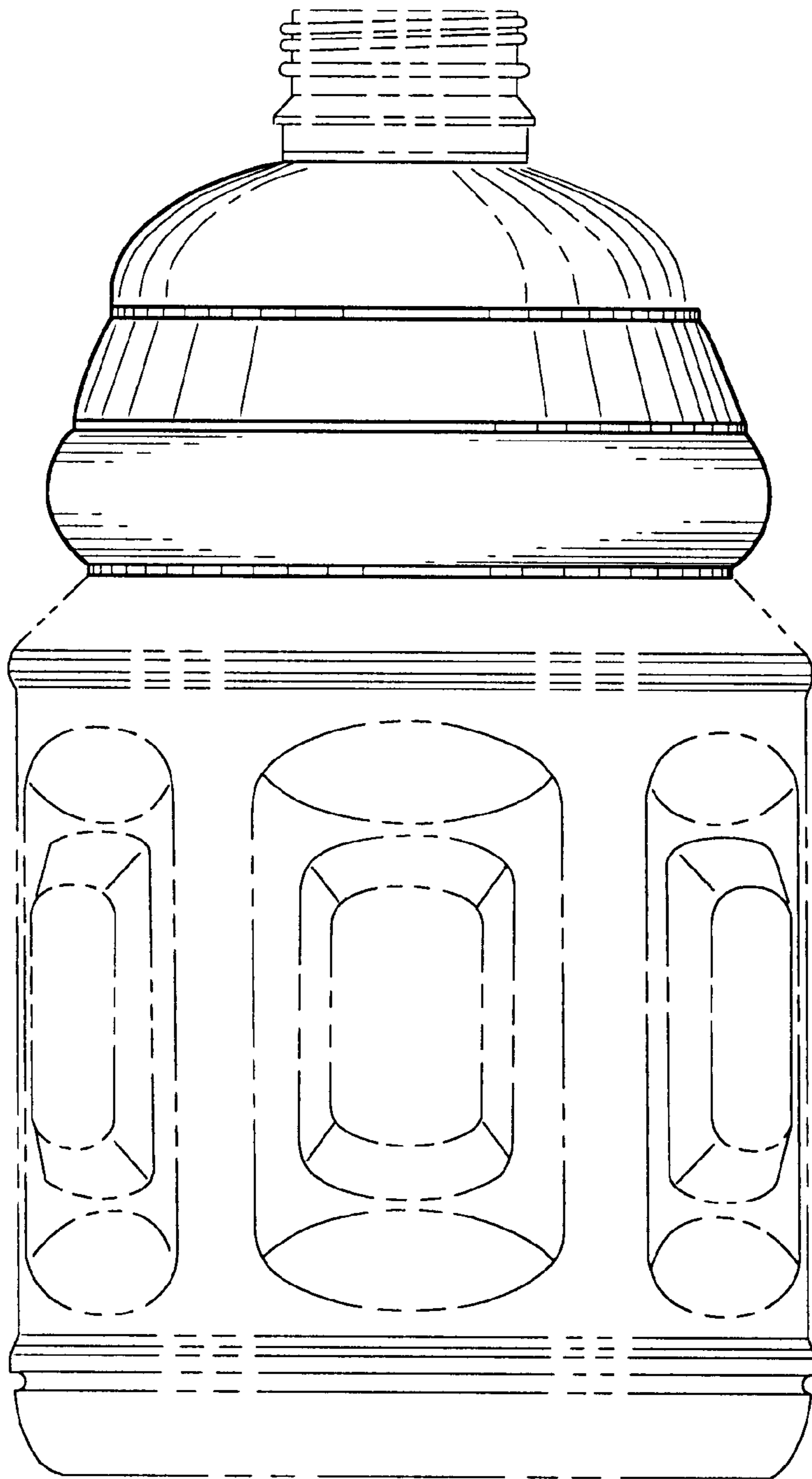

FIG. 3

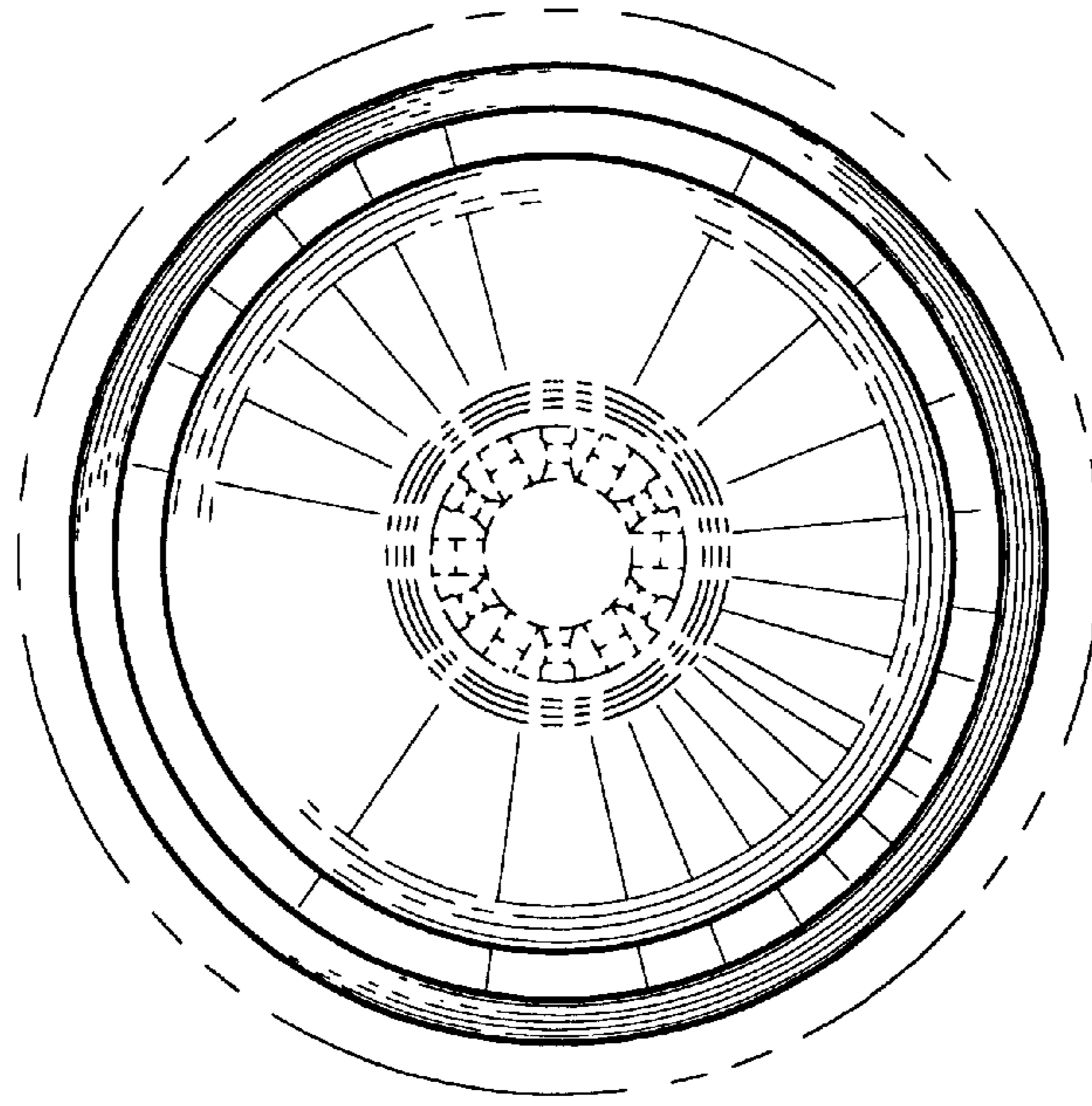

FIG. 4

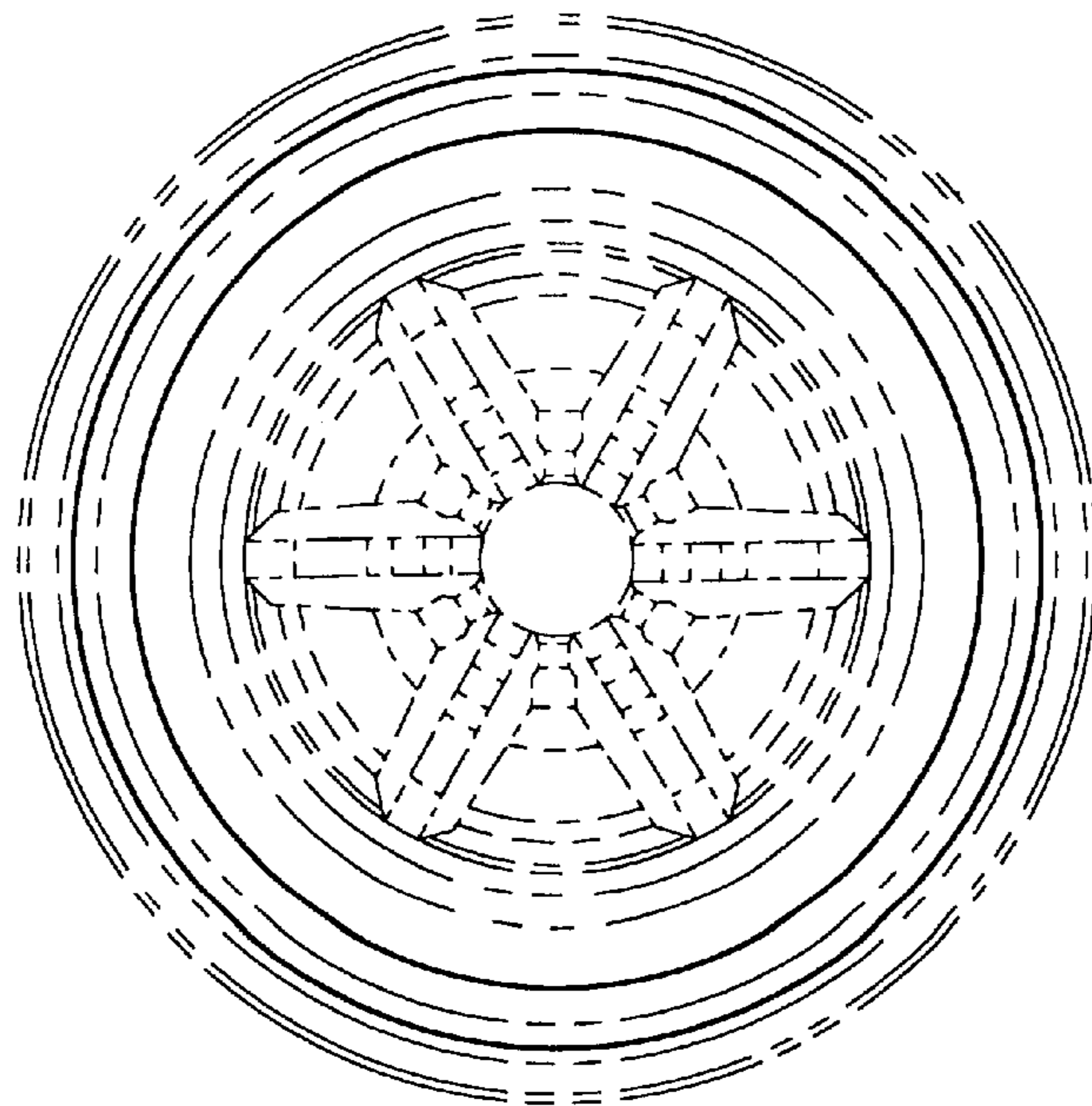

FIG. 5

UNITED STATES PATENT AND TRADEMARK OFFICE
CERTIFICATE OF CORRECTION

PATENT NO. : Des. 421,720
DATED : March 21, 2000
INVENTOR(S) : Eberle et al.

It is certified that error appears in the above-identified patent and that said Letters Patent is hereby corrected as shown below:

Cover Page, Column 1, Line 3 of "Inventors", delete "Joilet" and insert --Joliet-- therefor.
Cover Page, Column 1, Line 5 beneath "U.S. PATENT DOCUMENTS" delete "10/1996 Plummer" and insert --10/1976 Plummer-- therefor.
Cover Page, Column 1, Line 13 beneath "U.S. PATENT DOCUMENTS" delete "Vaillencourt et al." and insert --Vailliencourt et al.-- therefor.
Cover Page, Column 1, beneath "OTHER PUBLICATIONS" insert --Packaging, October 1987, page 12 "Gatorade" bottle (Copy in Bottle Digest)--.
Cover Page, Column 2, Line 11, delete "possibly Graham" and insert --possibly by Graham-- therefor.

Signed and Sealed this
Eighth Day of May, 2001

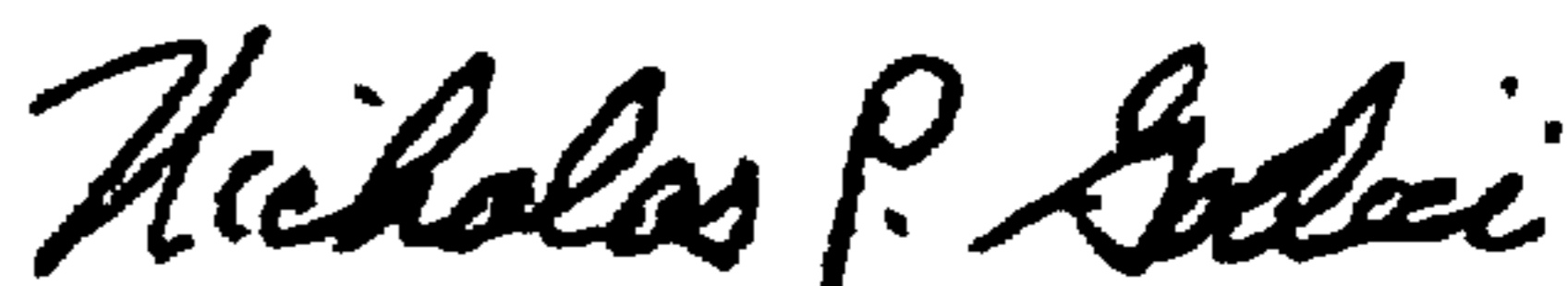

NICHOLAS P. GODICI

Attest:

Attesting Officer

Acting Director of the United States Patent and Trademark Office