



US00D421606S

United States Patent [19]

[11] **Patent Number: Des. 421,606**

Montalbo et al.

[45] **Date of Patent: ** Mar. 14, 2000**

[54] **SPEAKERPHONE WITH HANDSET**

[75] Inventors: **Roland Montalbo**, San Jose; **Jay Wilson**, Portola Valley, both of Calif.; **Scott Wakefield**, Andover; **Ben Misrahi**, Arlington, both of Mass.

[73] Assignee: **Polycom, Inc.**, San Jose, Calif.

[**] Term: **14 Years**

[21] Appl. No.: **29/102,665**

[22] Filed: **Mar. 29, 1999**

[51] **LOC (6) Cl.** **14-03**

[52] **U.S. Cl.** **D14/151**

[58] **Field of Search** D14/140, 142, D14/147-151, 240, 241, 243, 137, 144, 141; 379/419, 420, 428, 440, 434-436

[56] **References Cited**

U.S. PATENT DOCUMENTS

- D. 271,487 11/1983 Breger .
- D. 286,774 11/1986 Geis et al. .
- D. 292,919 11/1987 Lagerbielke et al. .
- D. 300,628 4/1989 Wu .
- D. 305,118 12/1989 Pfeifer et al. .
- D. 306,730 3/1990 Sugano et al. .
- D. 313,995 1/1991 Azpeita Ortizd.Arri .
- D. 325,031 3/1992 Chan .
- D. 332,450 1/1993 Kolinen .
- D. 346,383 4/1994 Mehle-Hohnjec et al. .
- D. 347,732 6/1994 Hinman et al. D14/150
- D. 349,899 8/1994 Siddoway et al. D14/150
- D. 352,944 11/1994 Lee .
- D. 354,487 1/1995 Nogas D14/151
- D. 363,285 10/1995 Vessey et al. D14/151
- D. 371,782 7/1996 Behar et al. .
- D. 372,028 7/1996 Mo D14/151
- D. 373,585 9/1996 Nagele et al. D14/243 X
- D. 374,230 10/1996 Nuttall et al. .
- D. 375,741 11/1996 Mo .
- D. 377,793 2/1997 Biasotti et al. .
- D. 379,353 5/1997 Biasotti et al. .
- D. 379,811 6/1997 Biasotti et al. .
- D. 381,331 7/1997 Biskup et al. .
- D. 381,332 7/1997 Biasotti et al. .
- D. 381,656 7/1997 Biskup et al. .

- D. 382,265 8/1997 Bradley et al. .
- D. 384,658 10/1997 Backs et al. .
- D. 384,664 10/1997 Backs et al. .
- D. 384,954 10/1997 Nuttall et al. .
- D. 384,956 10/1997 Chong .
- D. 386,496 11/1997 Backs et al. .
- D. 388,085 12/1997 Diamantis et al. .
- D. 388,087 12/1997 Diamantis et al. .
- D. 388,433 12/1997 Lepack .
- D. 391,955 3/1998 Nagele et al. .
- D. 399,201 10/1998 Zeitman D14/151
- D. 411,995 7/1999 Chen D14/150
- 5,912,967 6/1999 Gaffney et al. 379/420

OTHER PUBLICATIONS

Speakerphone 906, <http://telephones.att.com>, pp. 1-2. Jun. 16, 1999.

2-Line Speakerphone 922, <http://telephone.att.com>, pp. 1-3. Jun. 16, 1999.

Hello Direct p. 45, Conference Pro, Spr 1997.

Primary Examiner—Jeffrey Asch
Attorney, Agent, or Firm—Carr & Ferrell LLP; Aaron Wininger

[57] **CLAIM**

The ornamental design for a speakerphone with handset, as shown and described.

DESCRIPTION

FIG. 1 is a perspective view showing the top, front and right side of a speakerphone;
FIG. 2 is a top plan view of the speakerphone of FIG. 1;
FIG. 3 is a front elevational view of the speakerphone of FIG. 1;
FIG. 4 is a right side elevational view of the speakerphone of FIG. 1;
FIG. 5 is a left side elevational view of the speakerphone of FIG. 1;
FIG. 6 is a rear elevational view of the speakerphone of FIG. 1; and,
FIG. 7 is a bottom plan view of the speakerphone of FIG. 1. The broken line showings throughout the views are for illustrative purposes only and form no part of the claimed design.

1 Claim, 5 Drawing Sheets

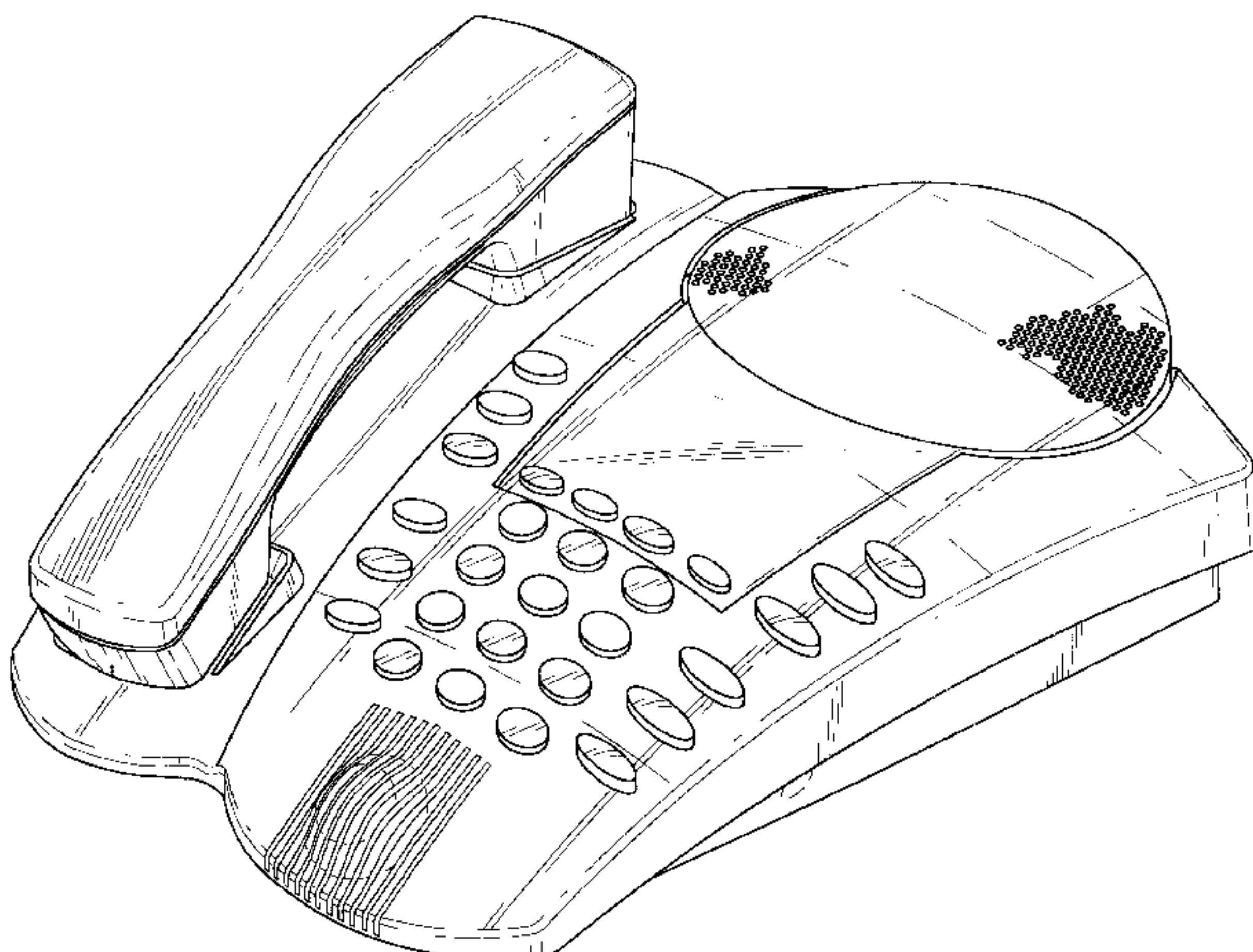

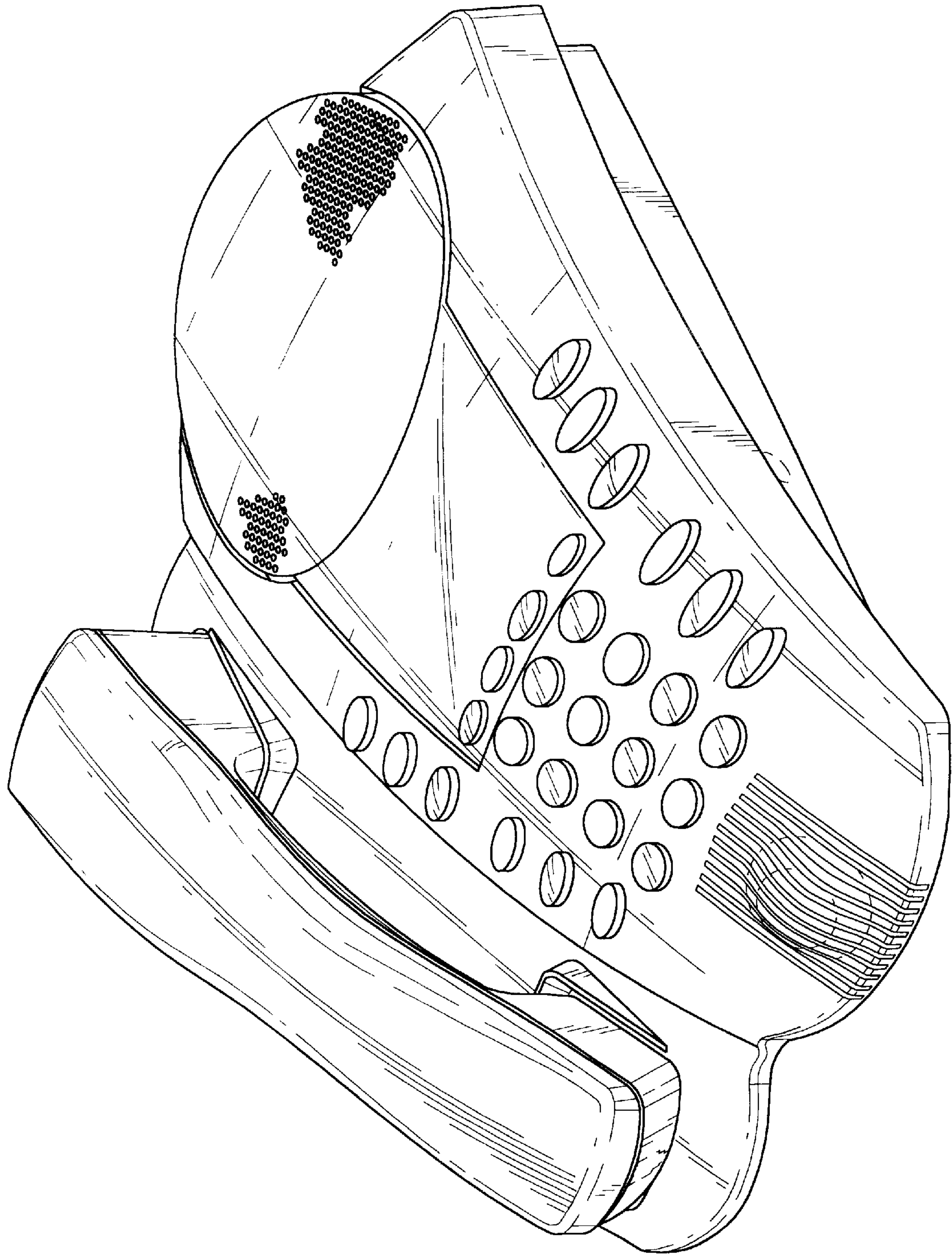

FIG. 1

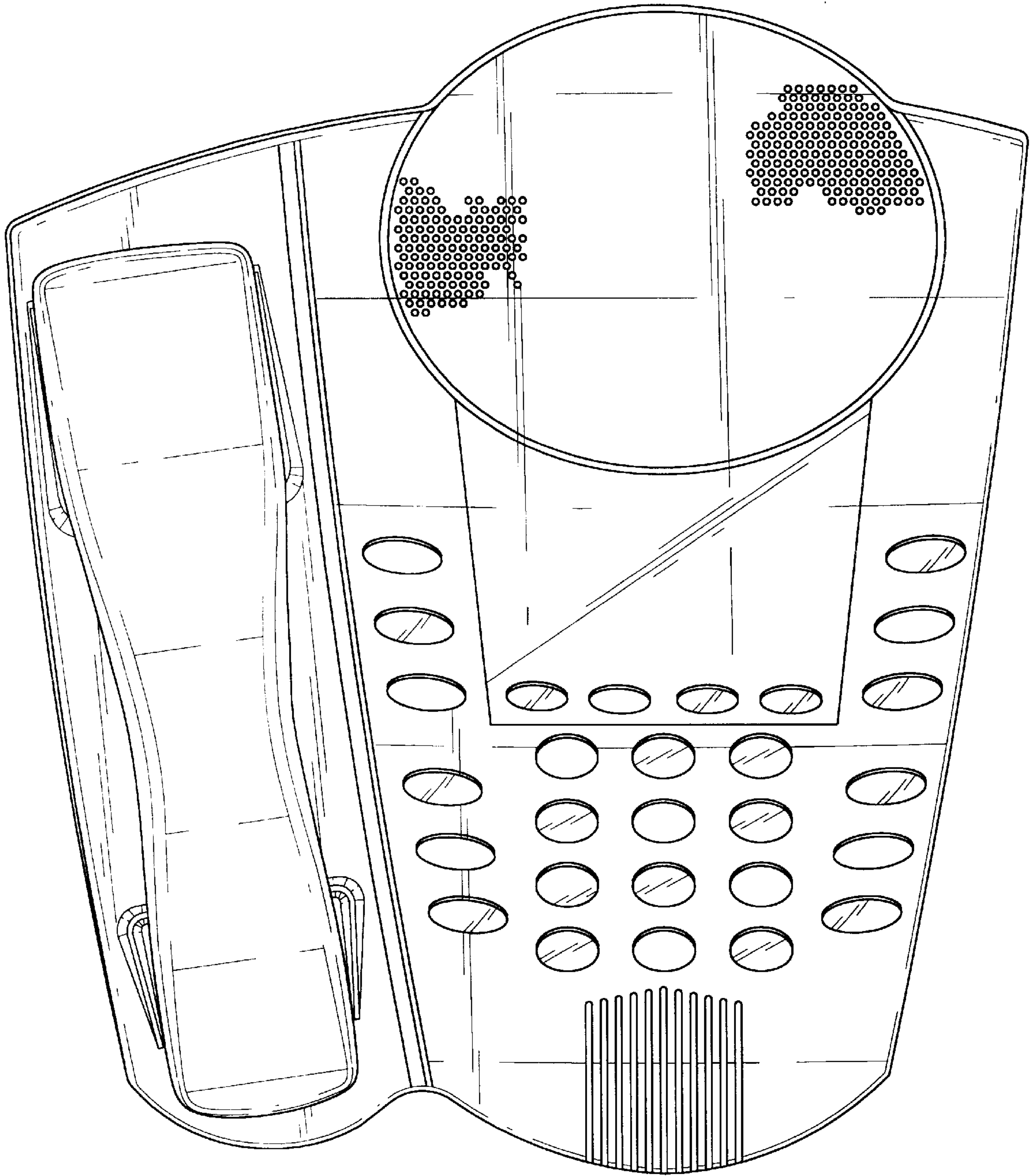

FIG. 2

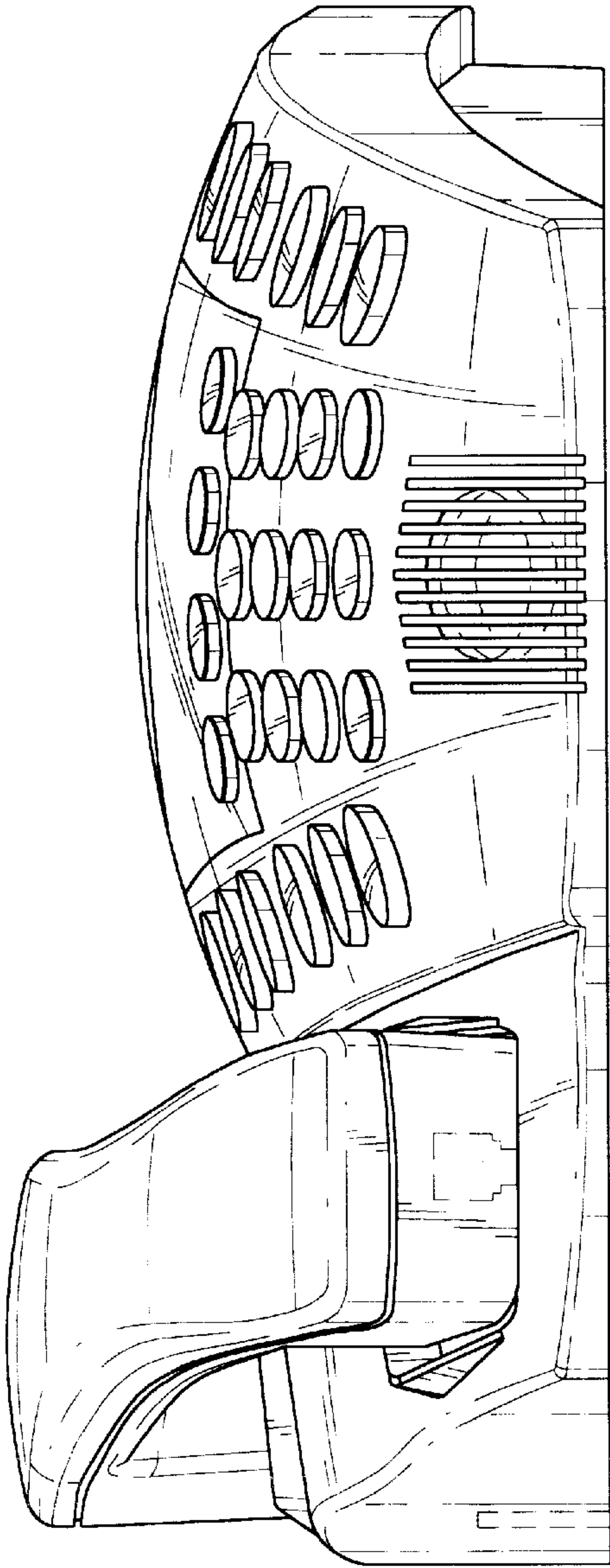

FIG. 3

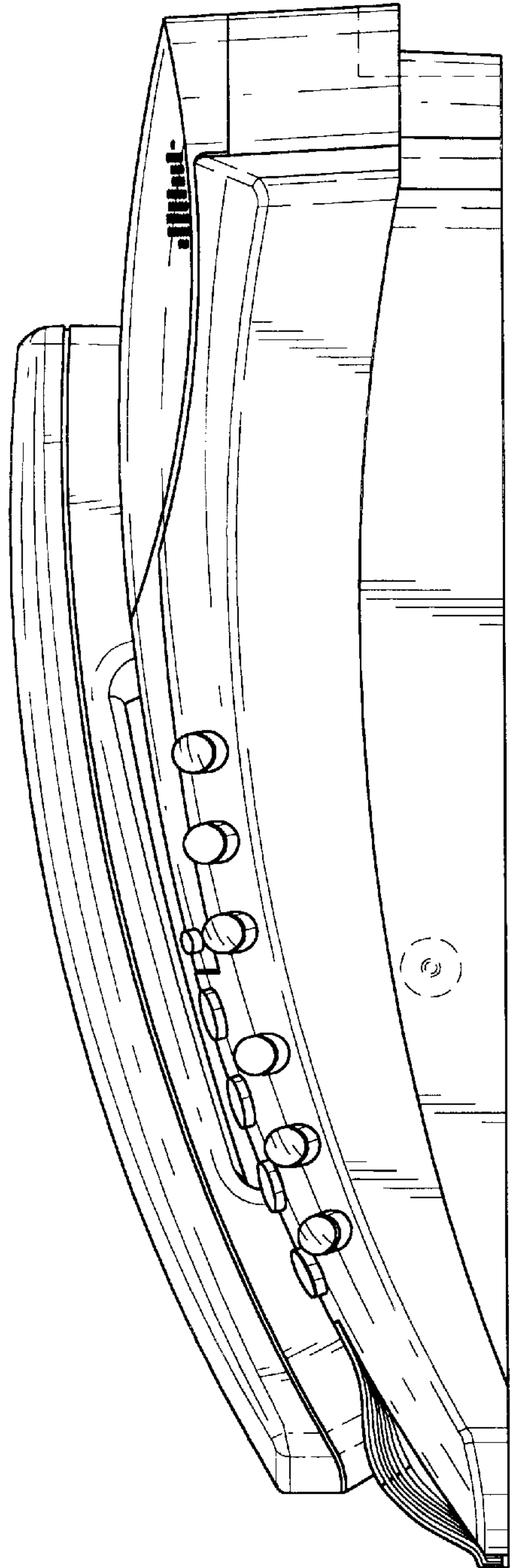

FIG. 4

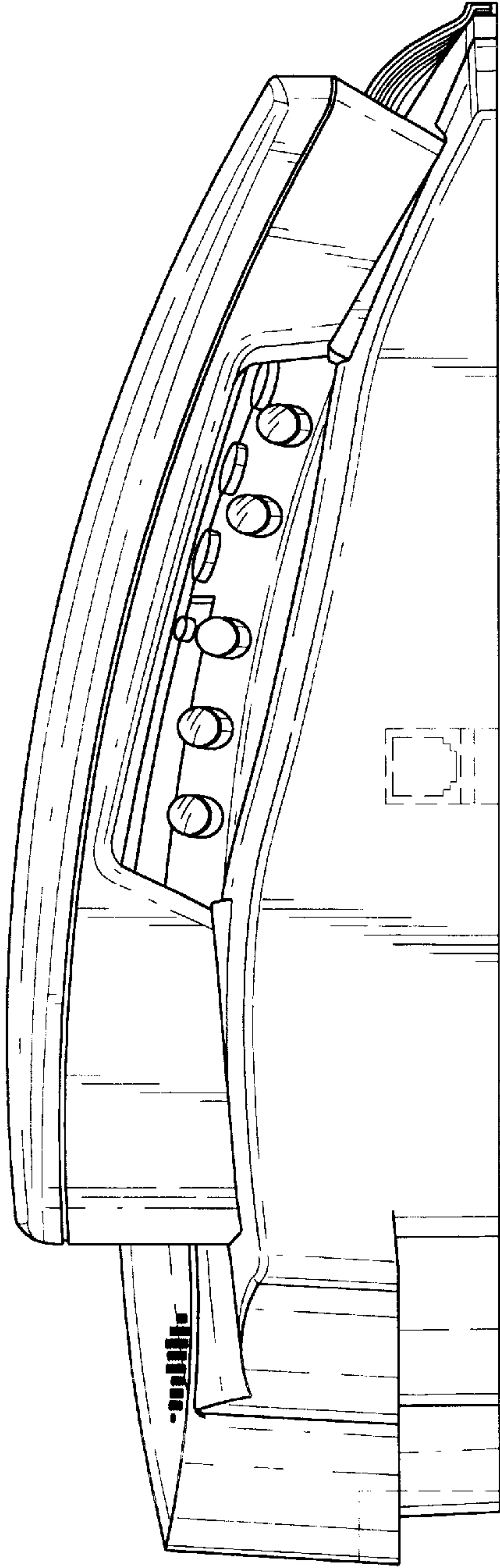

FIG. 5

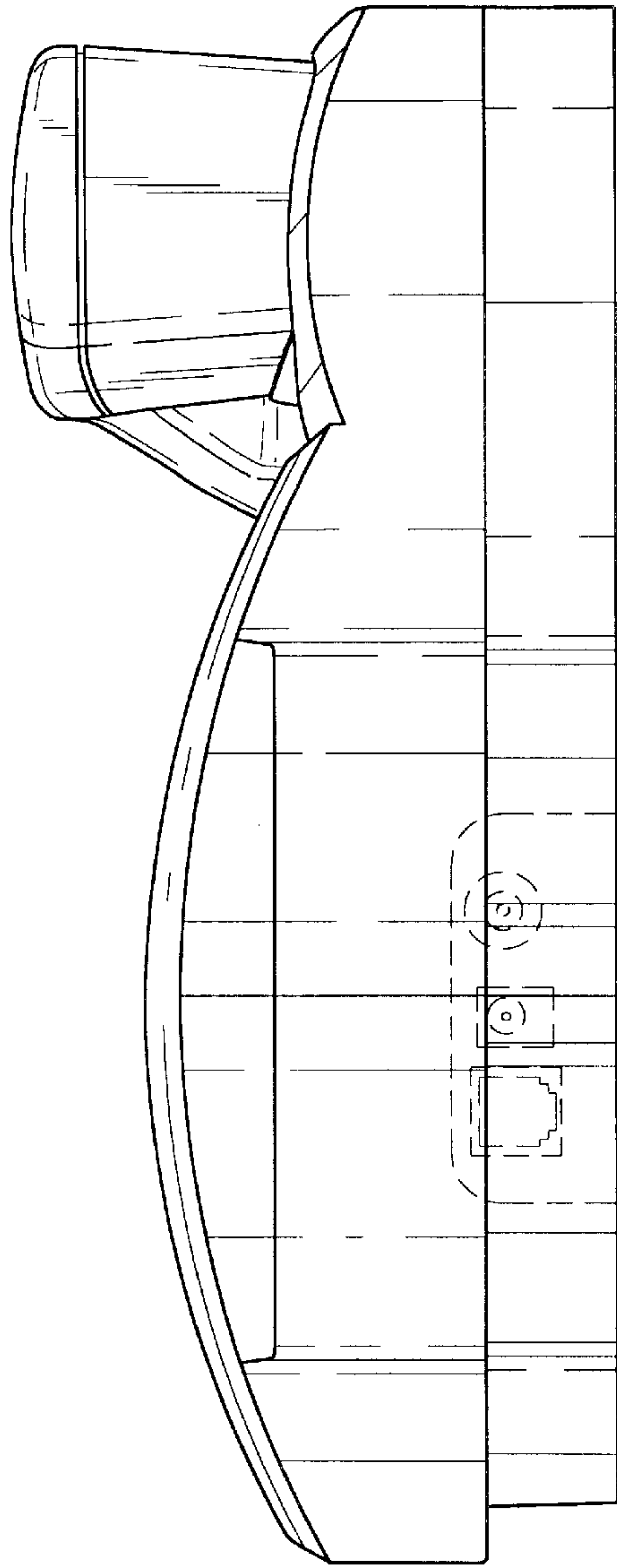

FIG. 6

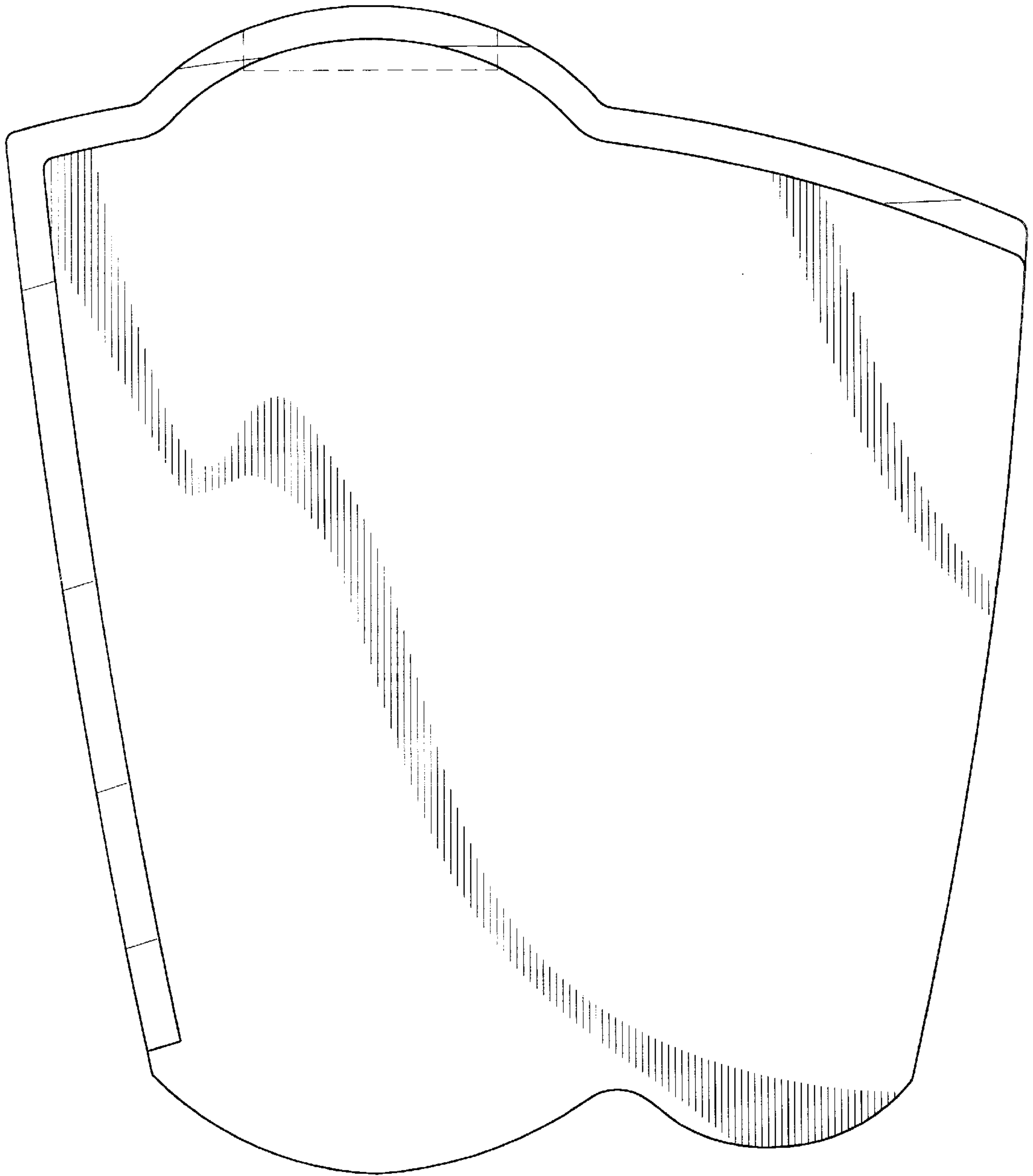

FIG. 7