



US00D421550S

United States Patent [19]

[11] **Patent Number: Des. 421,550**

Henry et al.

[45] **Date of Patent: ** Mar. 14, 2000**

[54] **BULK BIN**

[75] Inventors: **Eric Francis Henry**, Rutherford;
Tatsuo Rushing, Ringwood, both of
N.J.

[73] Assignee: **The Procter & Gamble Company**,
Cincinnati, Ohio

[**] Term: **14 Years**

[21] Appl. No.: **29/097,473**

[22] Filed: **Dec. 7, 1998**

[51] **LOC (6) Cl.** **07-01**

[52] **U.S. Cl.** **D7/589**

[58] **Field of Search** D7/589, 300; D6/512,
D6/542, 545, 515; D20/1, 3, 7; 222/173,
181.1, 185.1, 532

[56] **References Cited**

U.S. PATENT DOCUMENTS

D. 286,728	11/1986	Elmore .	
D. 295,590	5/1988	Merl et al.	D6/408
D. 309,402	7/1990	Morrow	D7/589
D. 328,007	7/1992	Mondry et al.	D7/589
D. 335,242	5/1993	Saunders	D7/589
D. 345,283	3/1994	Papanicholas	D7/589
D. 379,884	6/1997	Eastman	D5/472
D. 400,761	11/1998	Rushing	D7/589
D. 401,476	11/1998	Henry et al.	D7/589
D. 402,160	12/1998	Rushing	D7/589
D. 404,600	1/1999	Henry et al.	D6/509
3,908,831	9/1975	Brendgord	211/88
4,176,767	12/1979	Franche, IV	222/243
4,522,306	6/1985	Silver	211/49.1
4,531,646	7/1985	Howard	211/150
4,705,175	11/1987	Howard et al.	211/59.2
4,771,898	9/1988	Howard et al.	211/59.2

4,785,944	11/1988	March	211/59.2
5,197,610	3/1993	Bustos	211/59.2
5,236,344	8/1993	Baron	248/222.2
5,328,082	7/1994	Fritz et al.	229/122.1
5,361,937	11/1994	Wiese	221/189
5,673,823	10/1997	Hanks et al.	222/185.1

FOREIGN PATENT DOCUMENTS

2591201	6/1987	France	B65D 83/06
WO 96/06013	2/1996	WIPO .	
WO 96/33128	10/1996	WIPO	B65D 5/08

Primary Examiner—Terry A. Wallace
Attorney, Agent, or Firm—William Scott Andes

[57] **CLAIM**

The ornamental design for a bulk bin, as shown and described.

DESCRIPTION

FIG. 1 is a perspective view of a bulk bin, embodying our new design;

FIG. 2 is a rear elevational view thereof;

FIG. 3 is a side elevational view thereof, the opposite side elevational view being a mirror image thereof;

FIG. 4 is a front elevational view thereof;

FIG. 5 is a top view thereof;

FIG. 6 is a bottom view thereof;

FIGS. 7–11 are views corresponding to FIGS. 2–6, respectively, of an embodiment of the bulk bin having certain features depicted in broken lines for illustrative purposes only, and which form no part of the claimed invention of FIGS. 7–11; and,

FIG. 12 is a perspective view thereof, the remaining bins are shown in broken lines for illustrative purposes only and form no part of the claimed design.

1 Claim, 4 Drawing Sheets

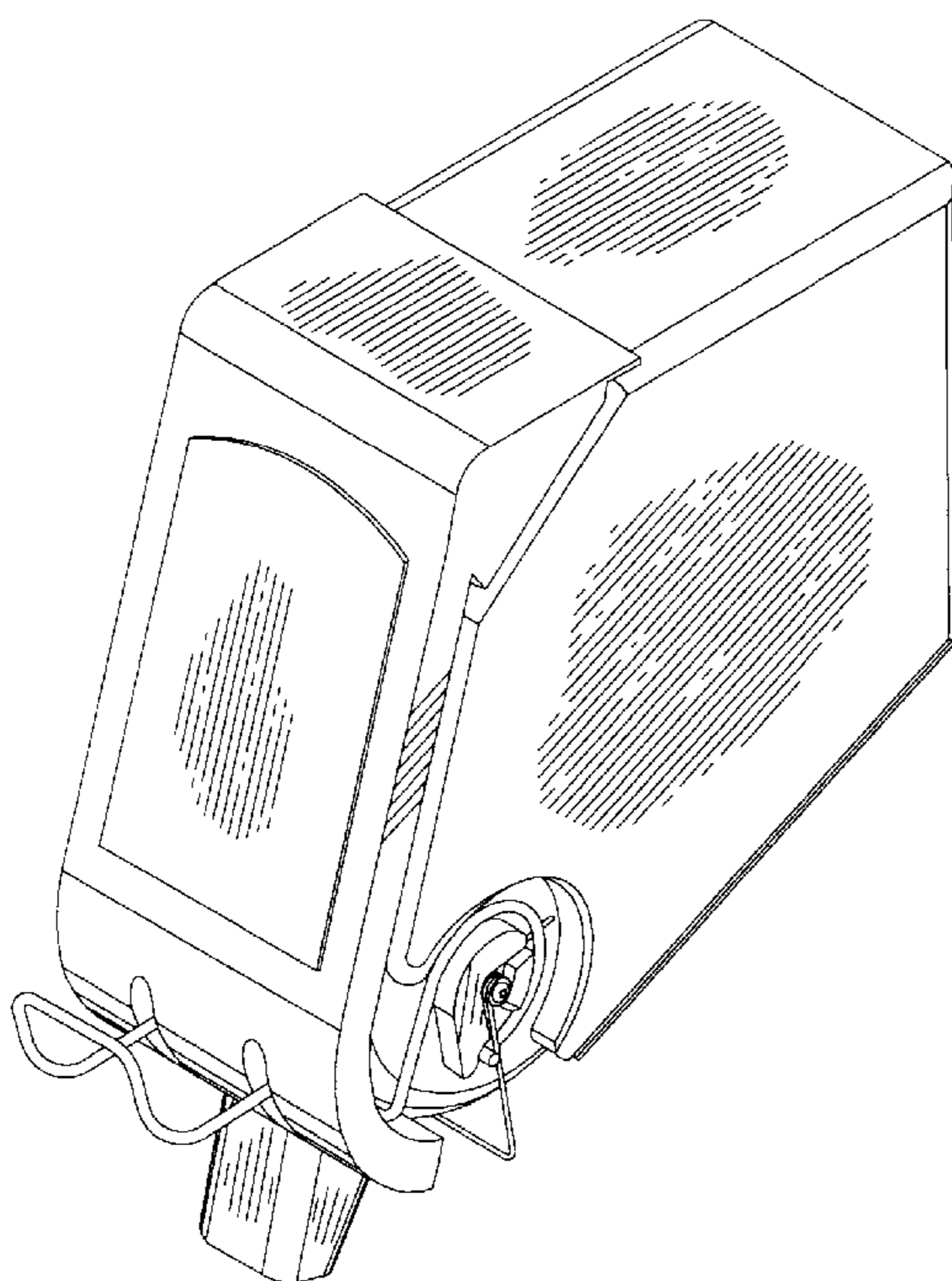

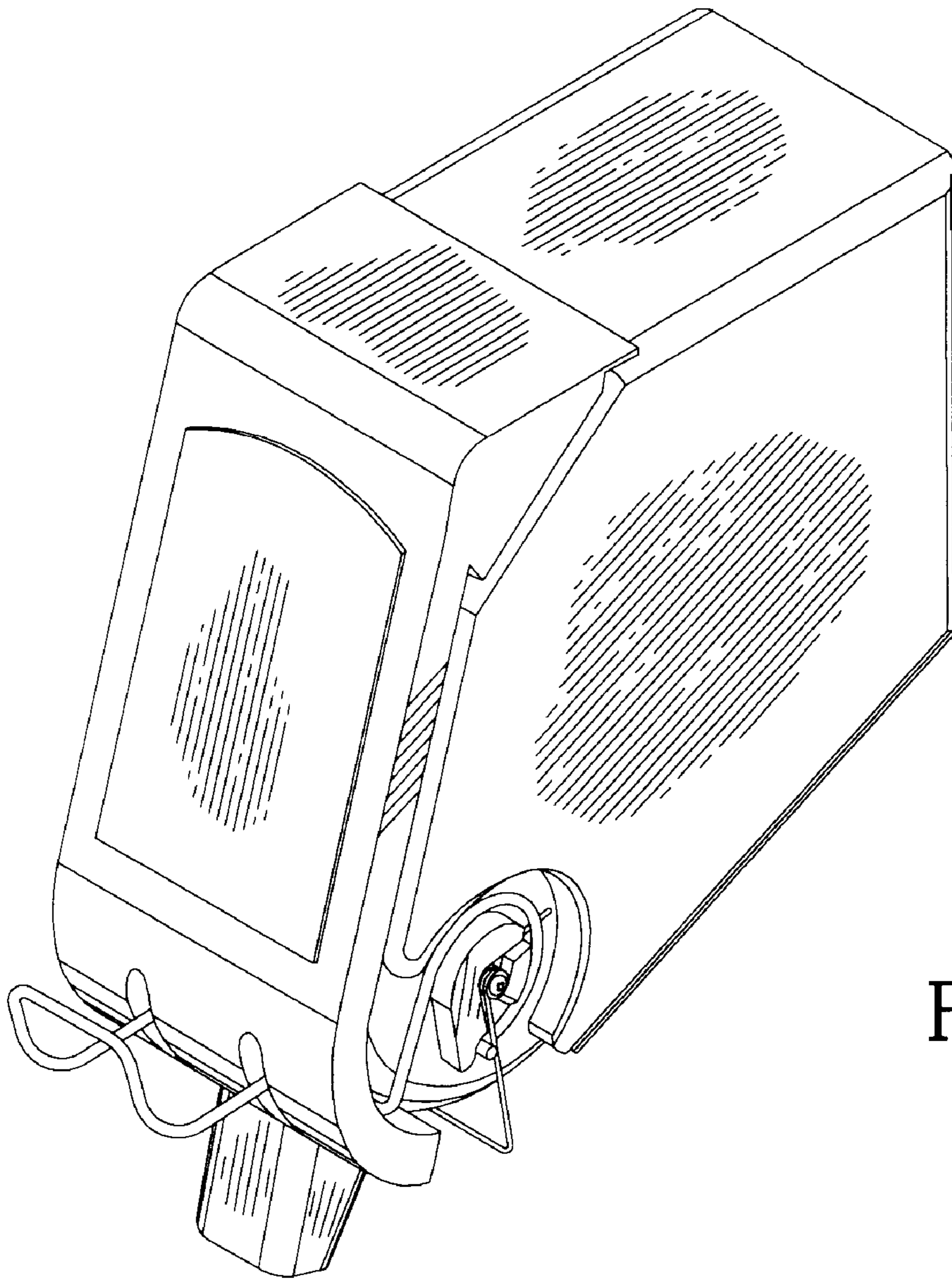

Fig. 1

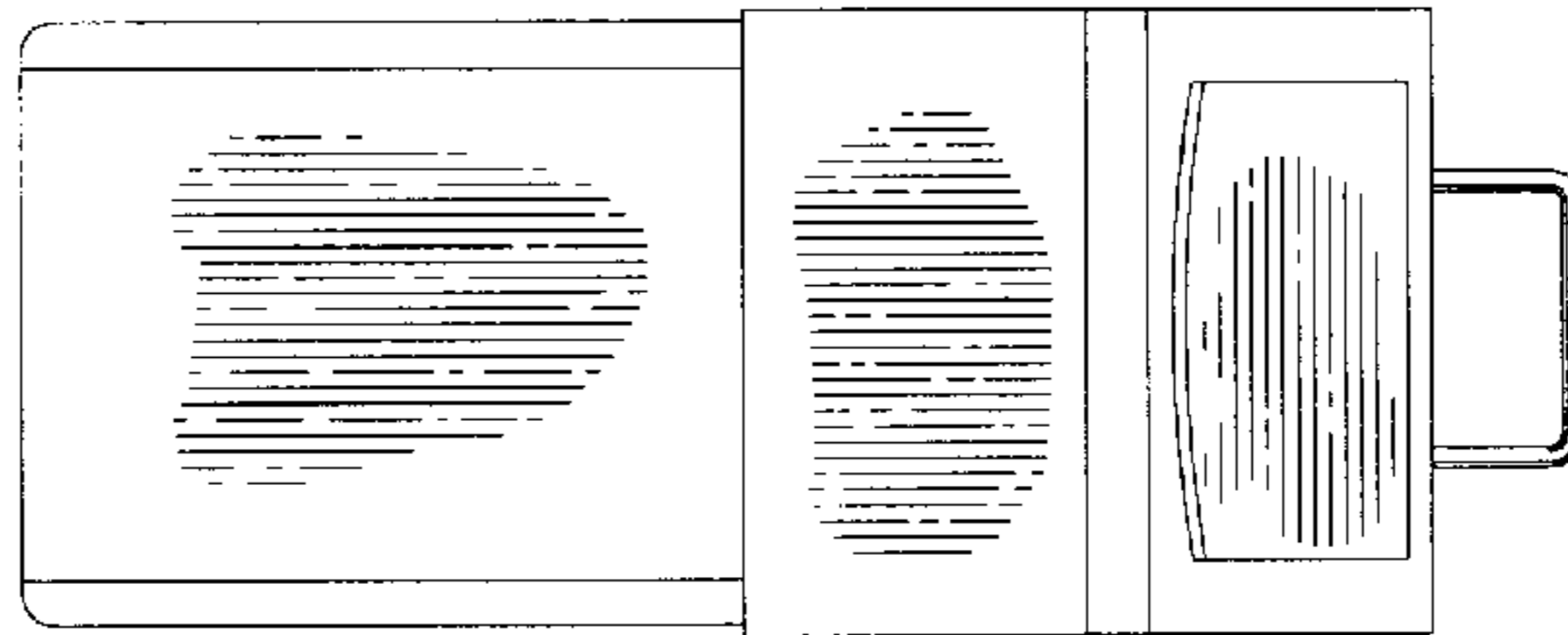

Fig. 5

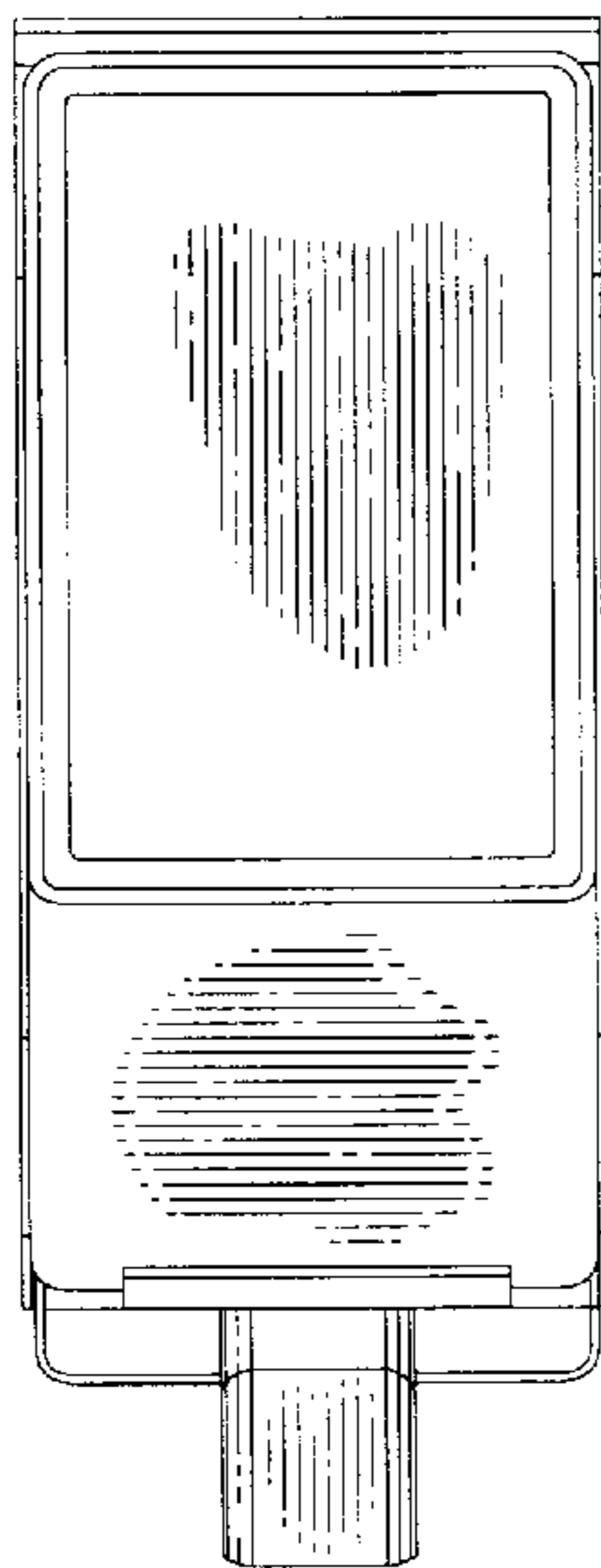

Fig. 2

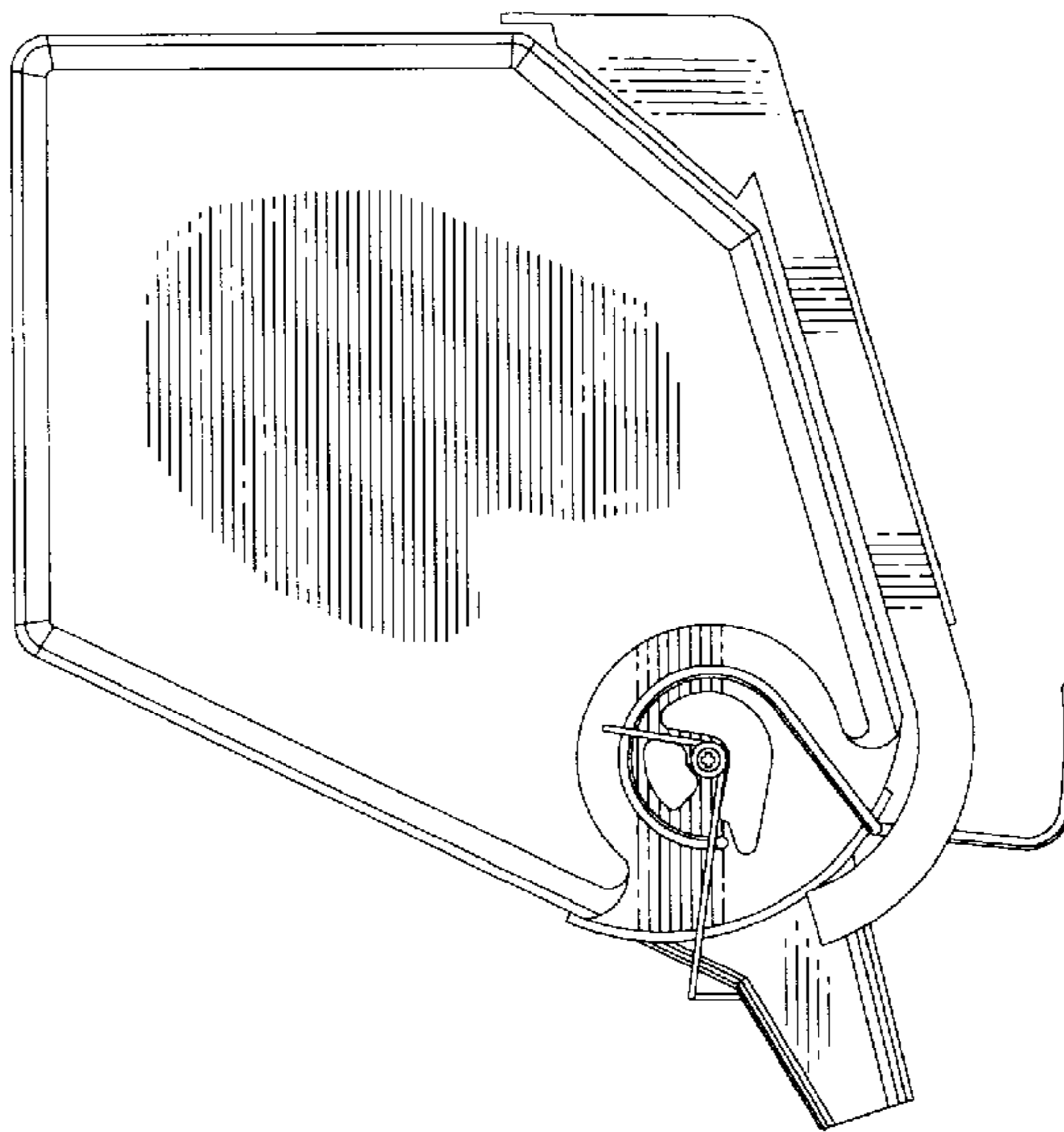

Fig. 3

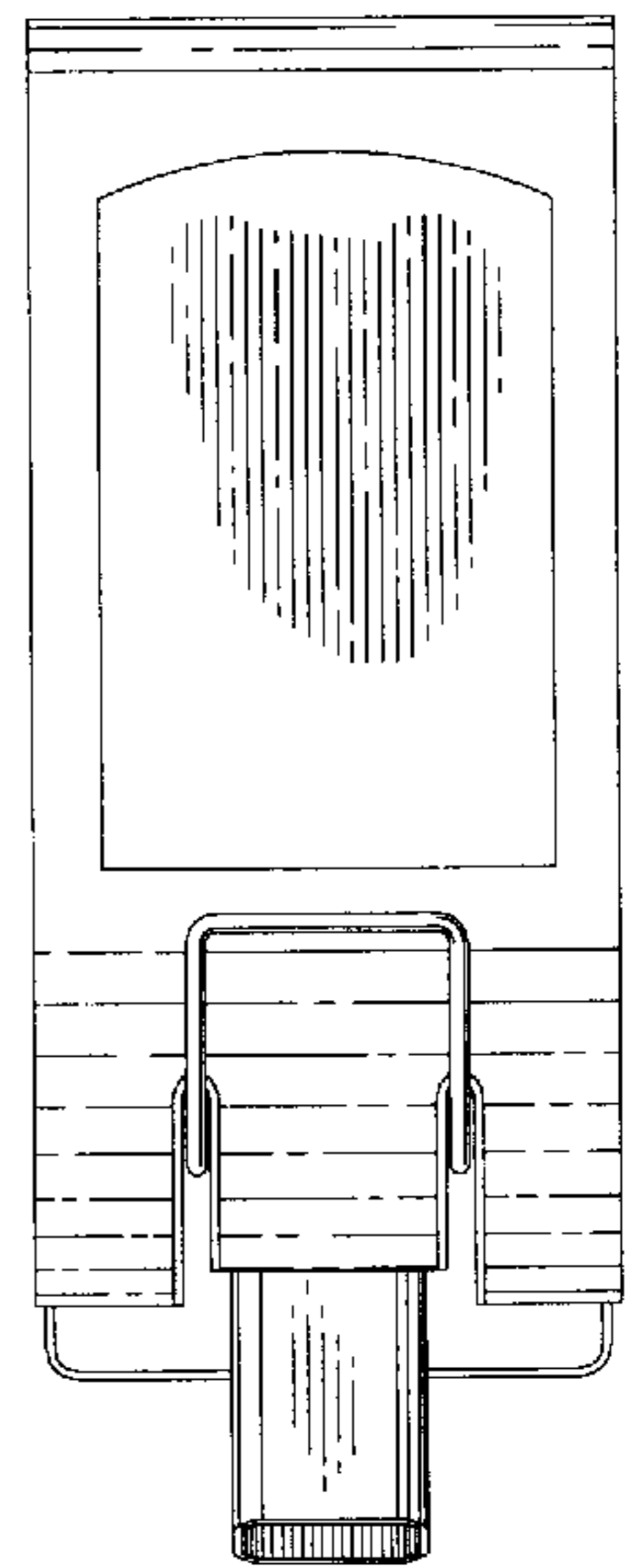

Fig. 4

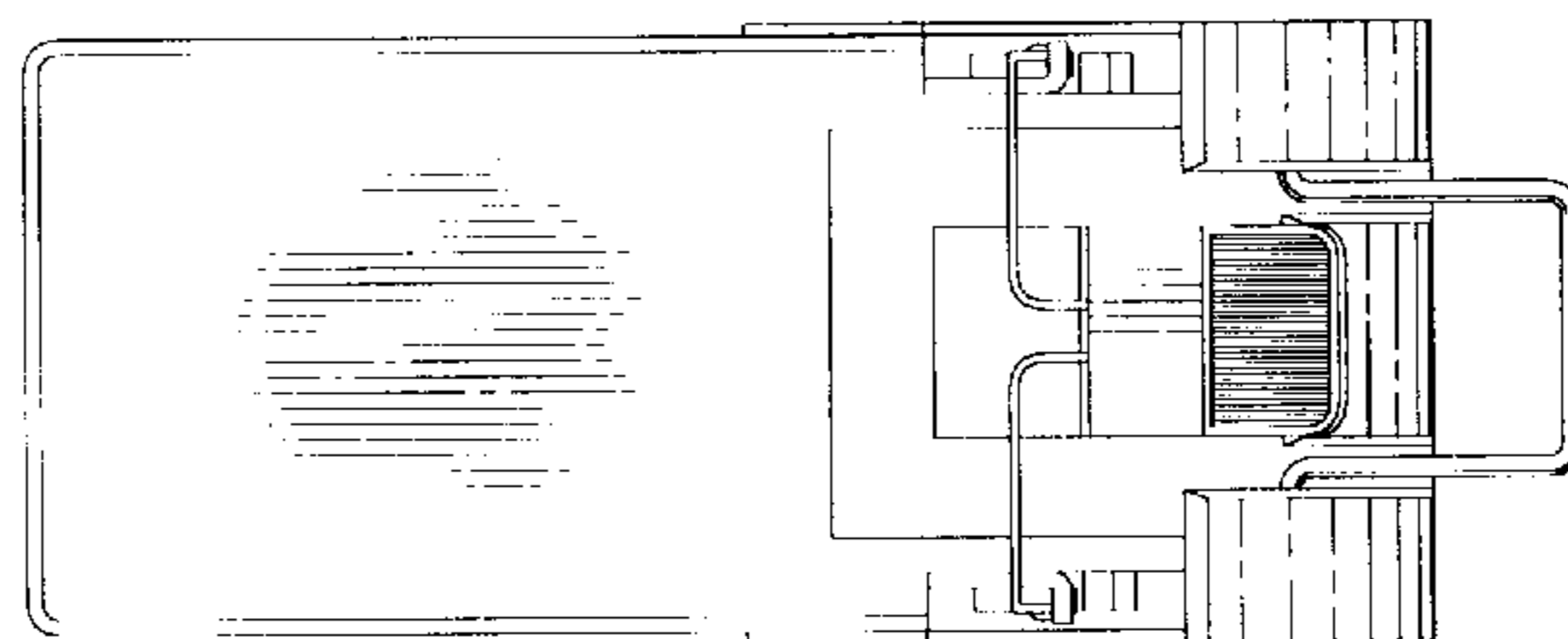

Fig. 6

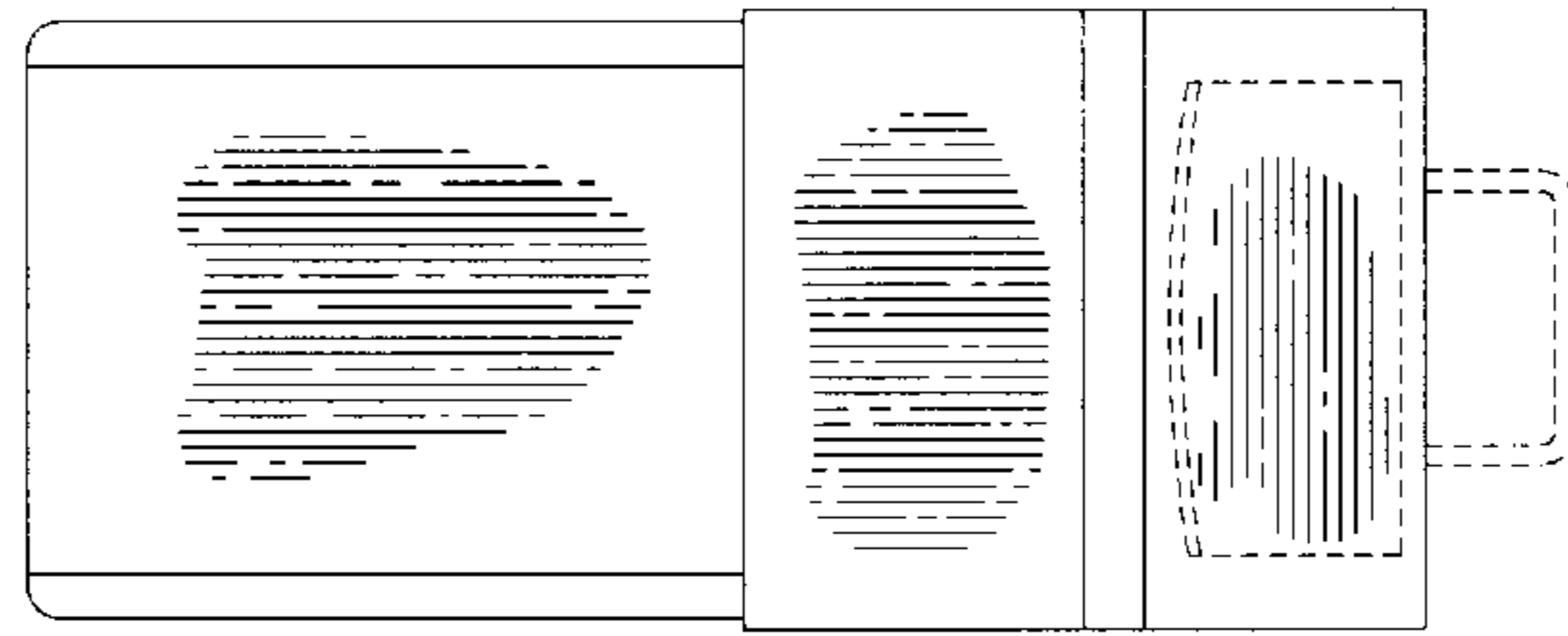

Fig. 10

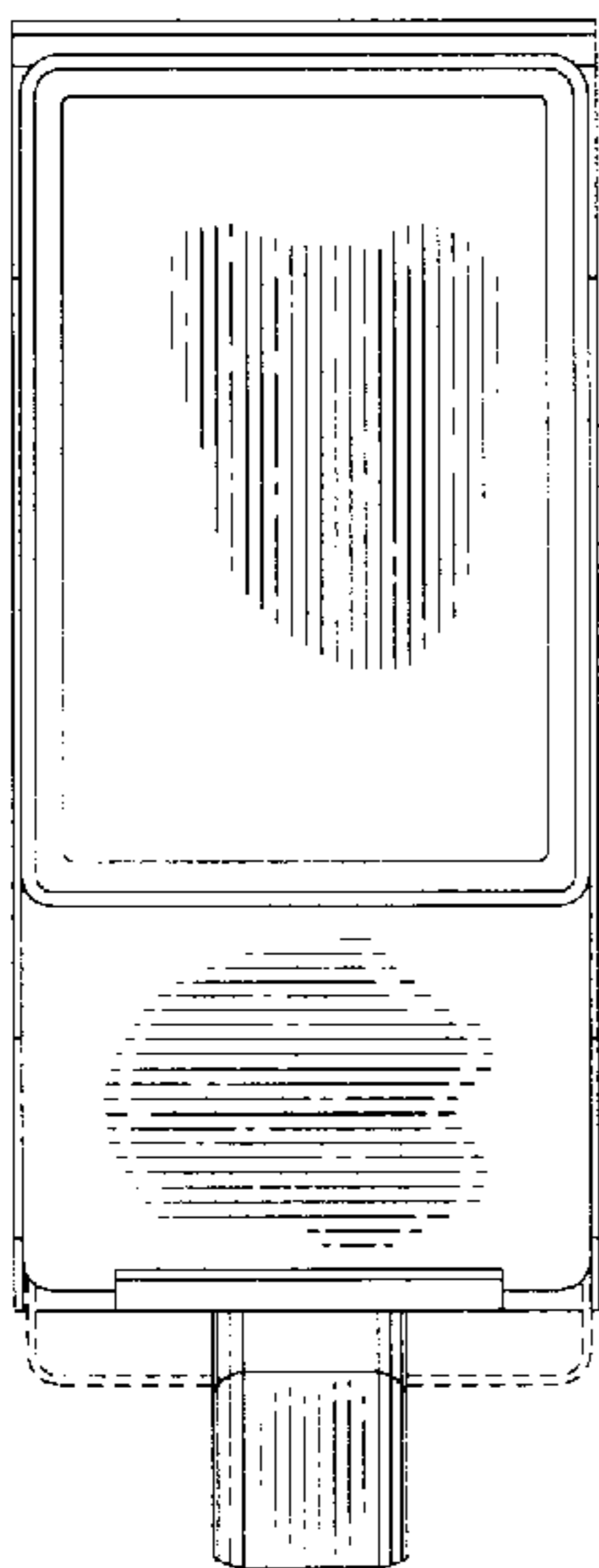

Fig. 7

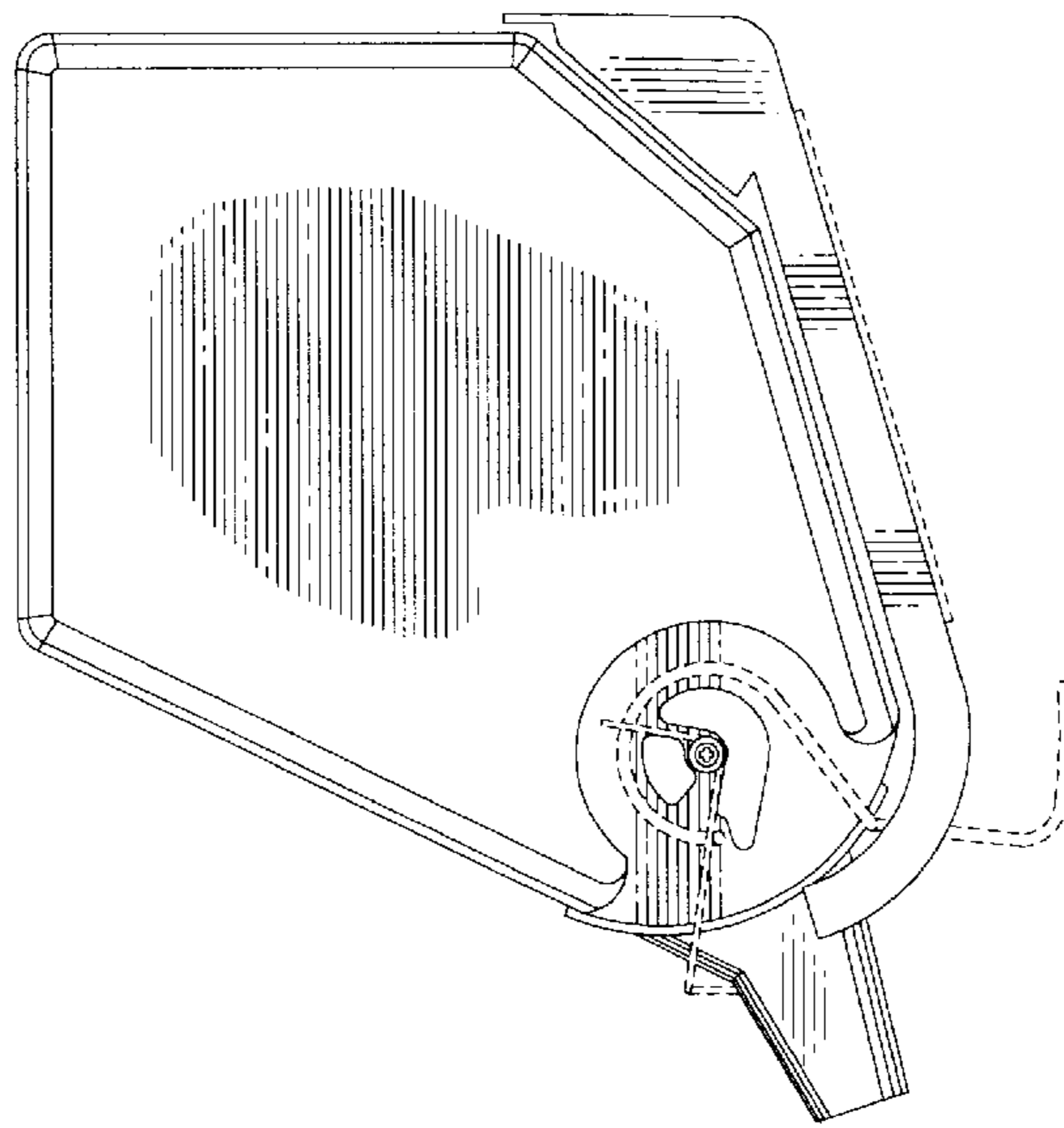

Fig. 8

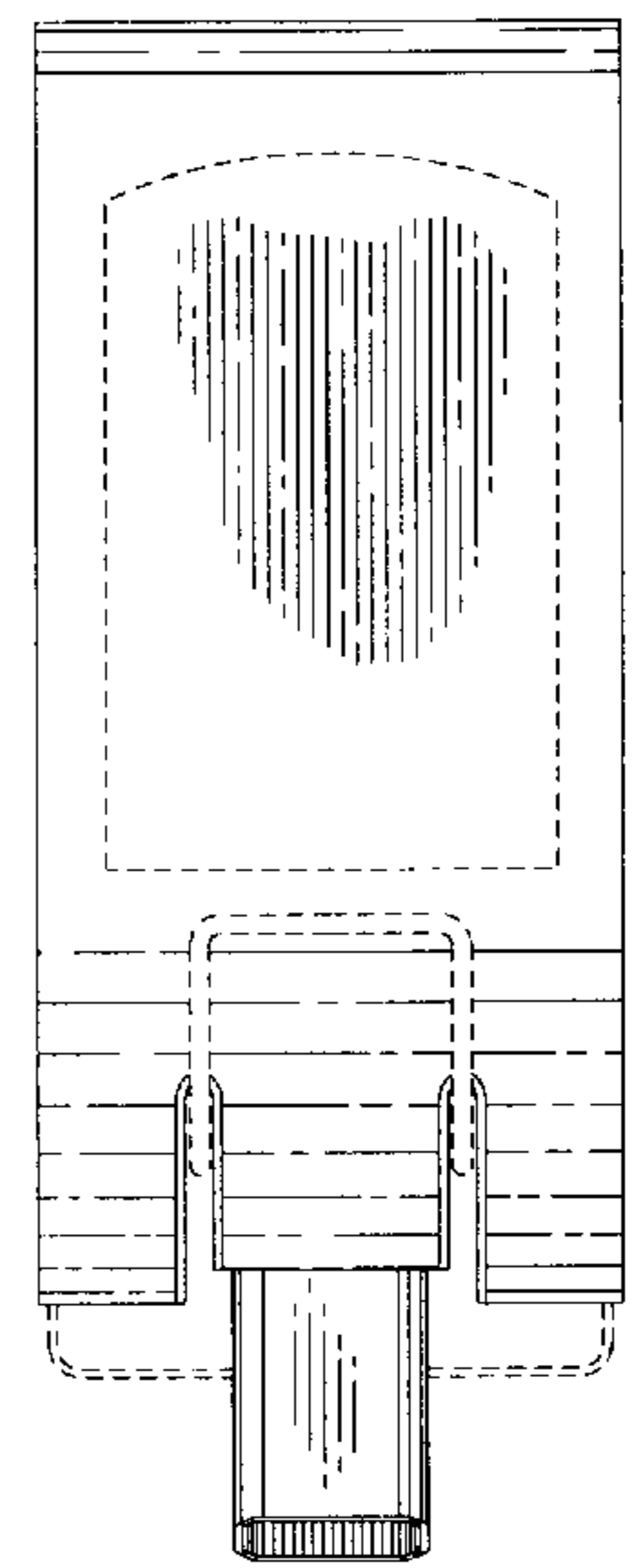

Fig. 9

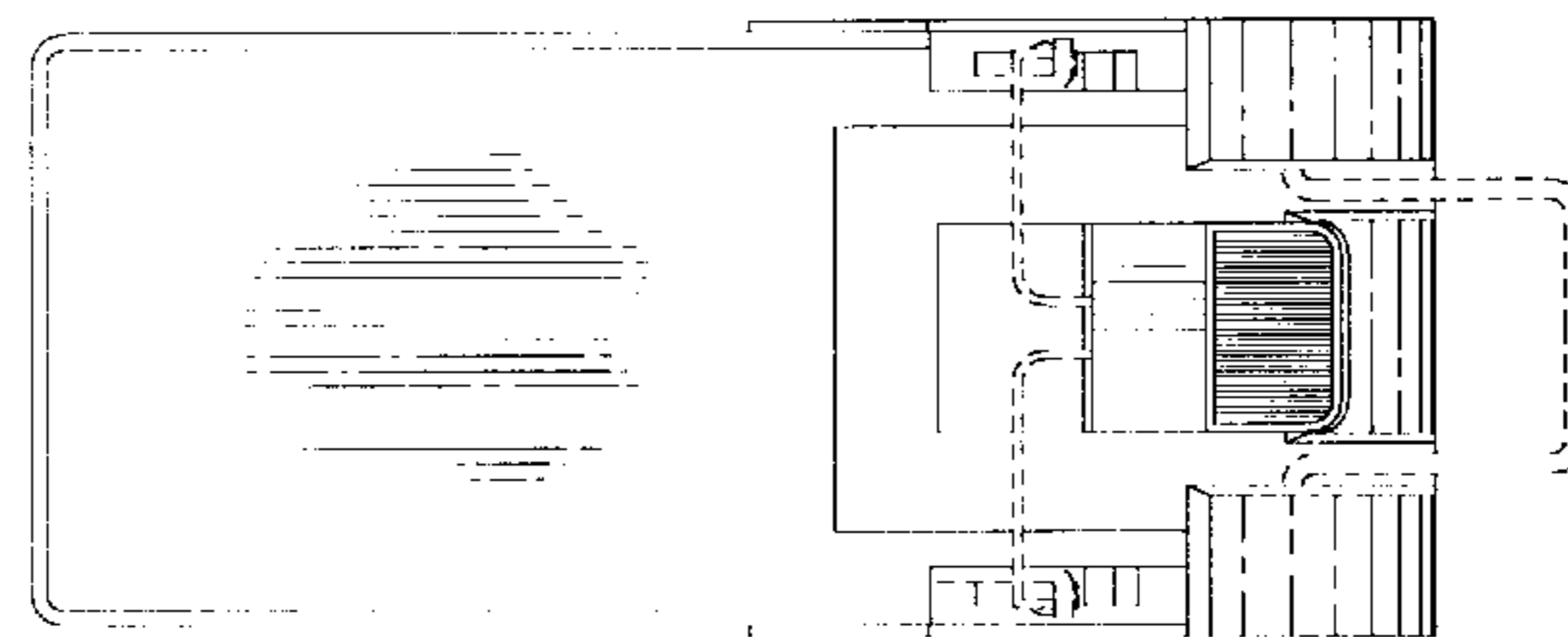

Fig. 11

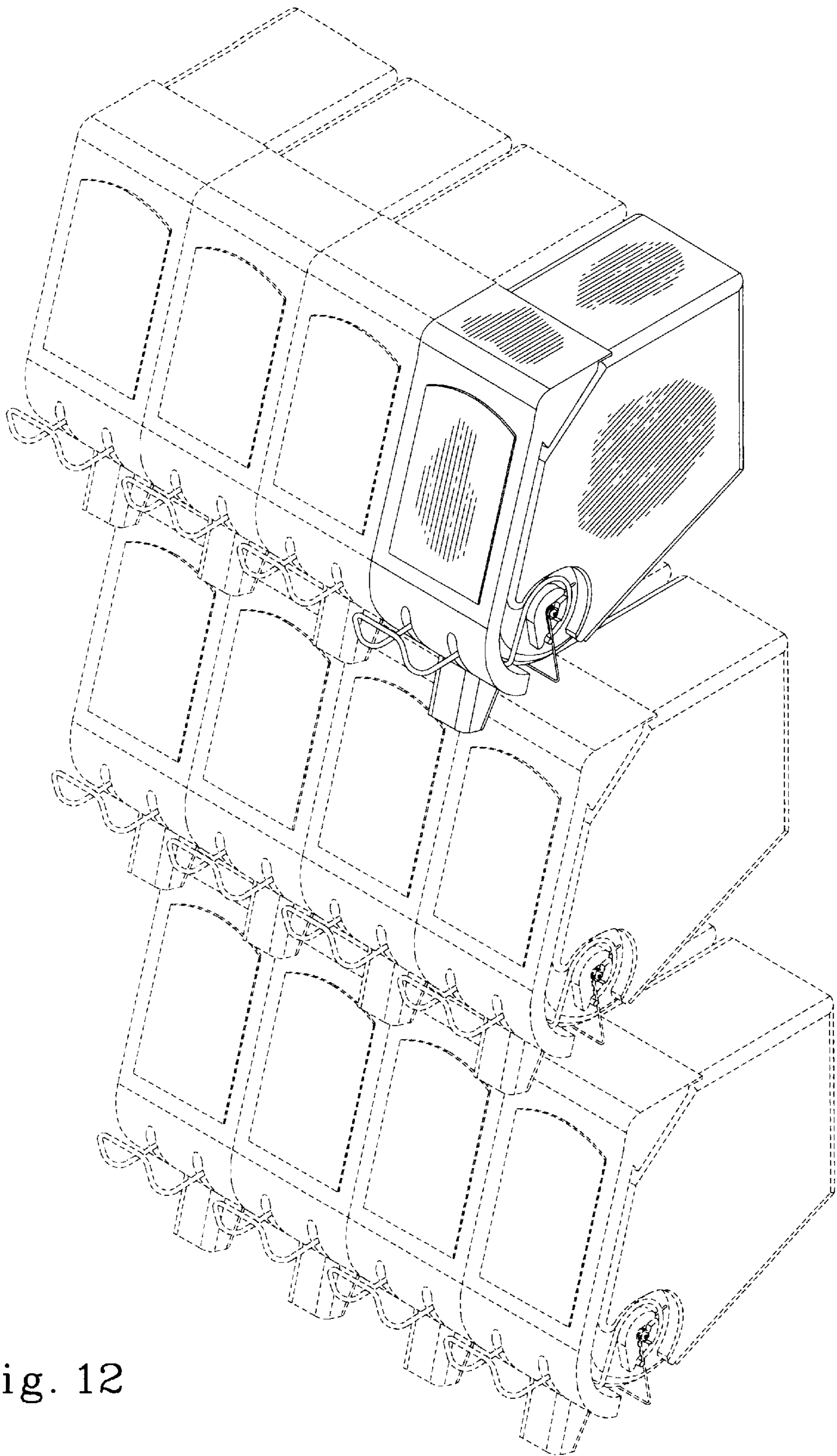

Fig. 12

UNITED STATES PATENT AND TRADEMARK OFFICE
CERTIFICATE OF CORRECTION

PATENT NO. : Des. 421,550
DATED : March 14, 2000
INVENTOR(S) : E. F. Henry et al.

Page 1 of 3

It is certified that error appears in the above-identified patent and that said Letters Patent is hereby corrected as shown below:

Delete sheets 2 and 3 and substitute therefore the attached substitute sheets 2 and 3.

Signed and Sealed this

Twenty-first Day of August, 2001

Attest:

Nicholas P. Godici

Attesting Officer

NICHOLAS P. GODICI
Acting Director of the United States Patent and Trademark Office

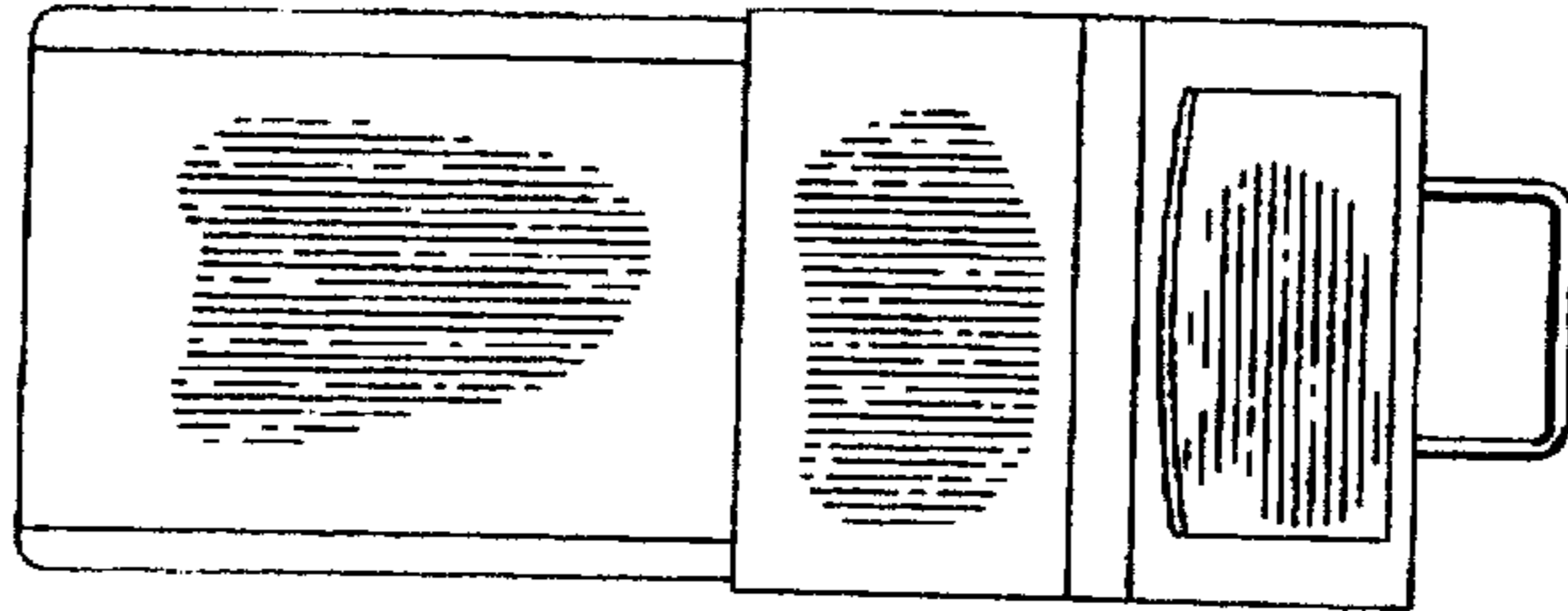

Fig. 5

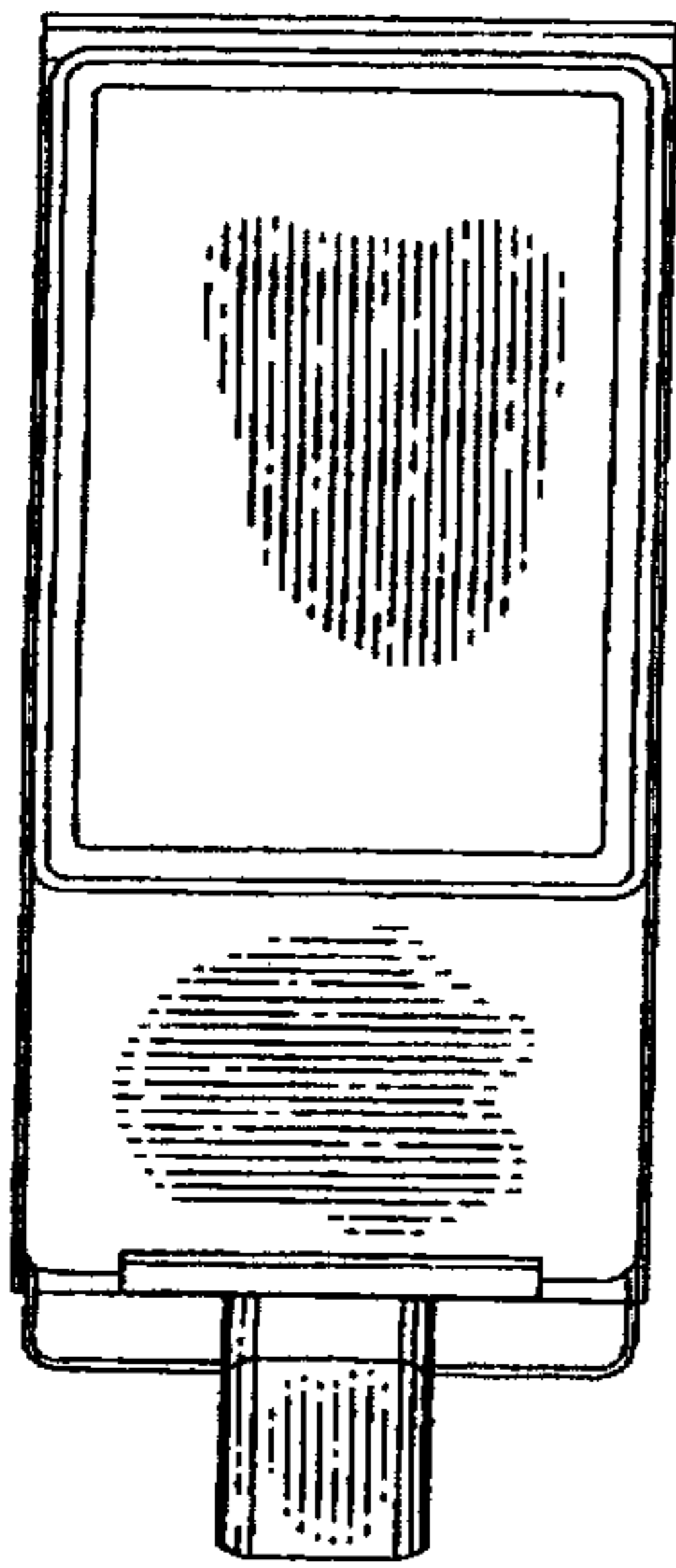

Fig. 2

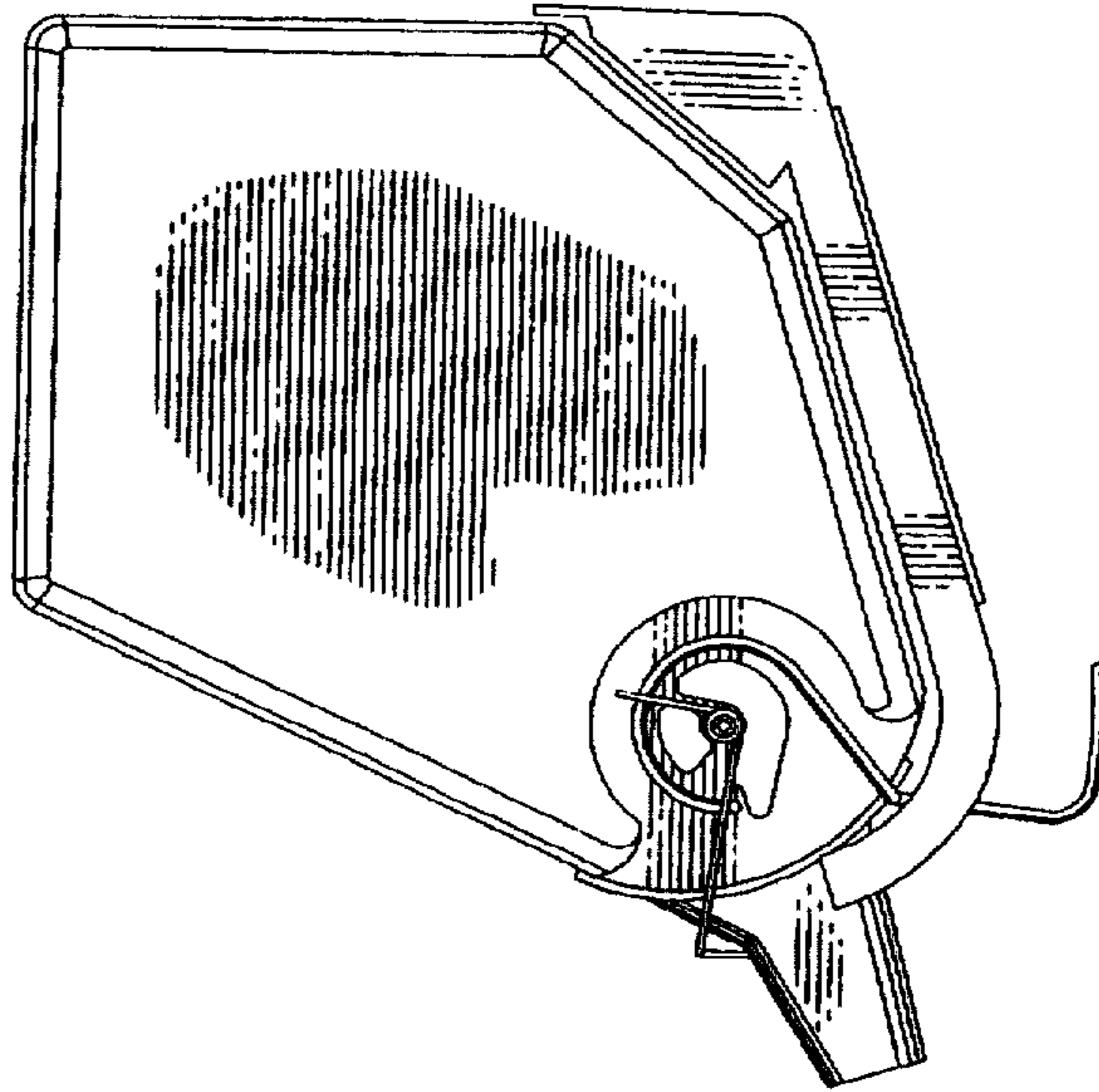

Fig. 3

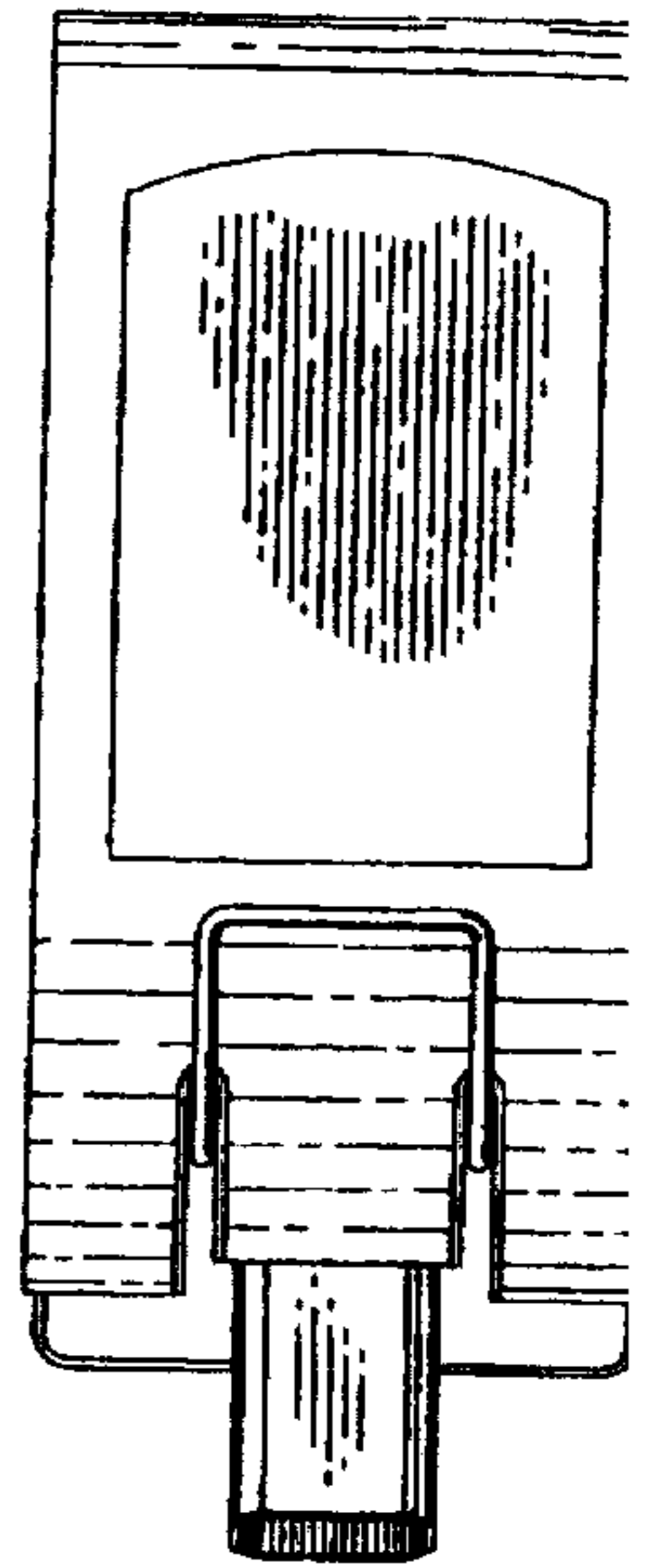

Fig. 4

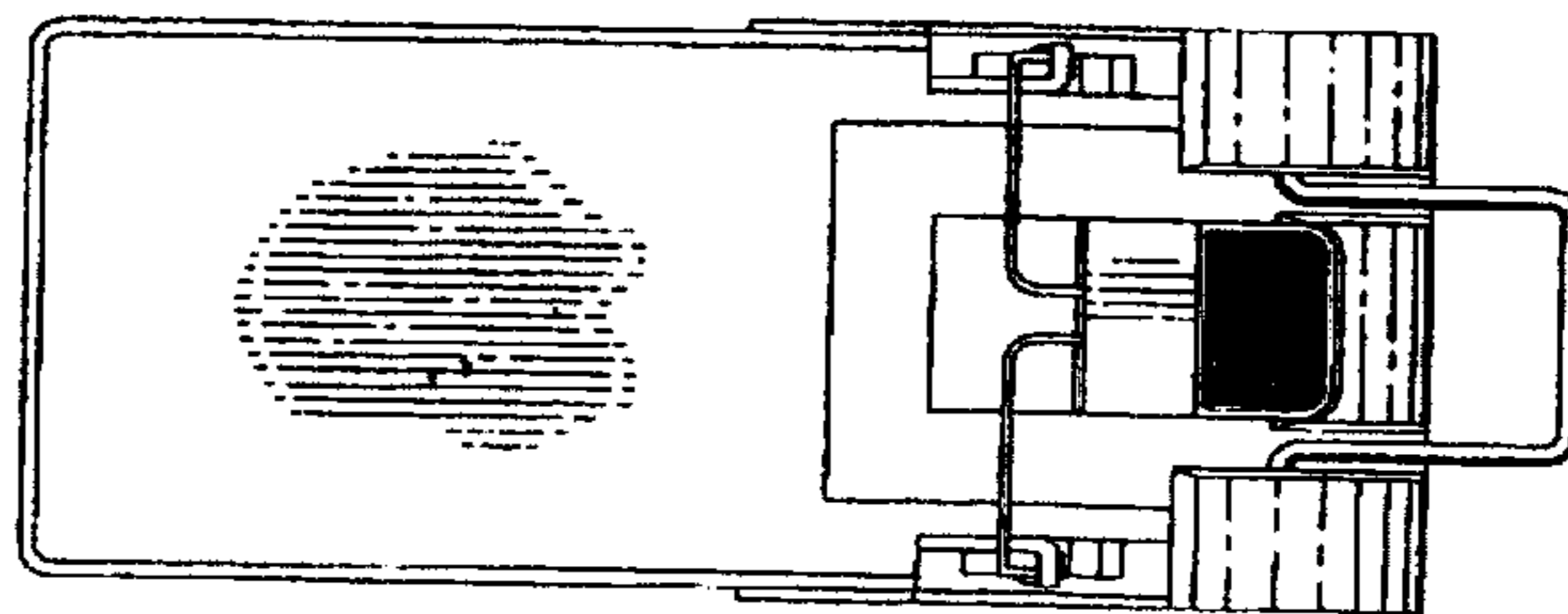

Fig. 6

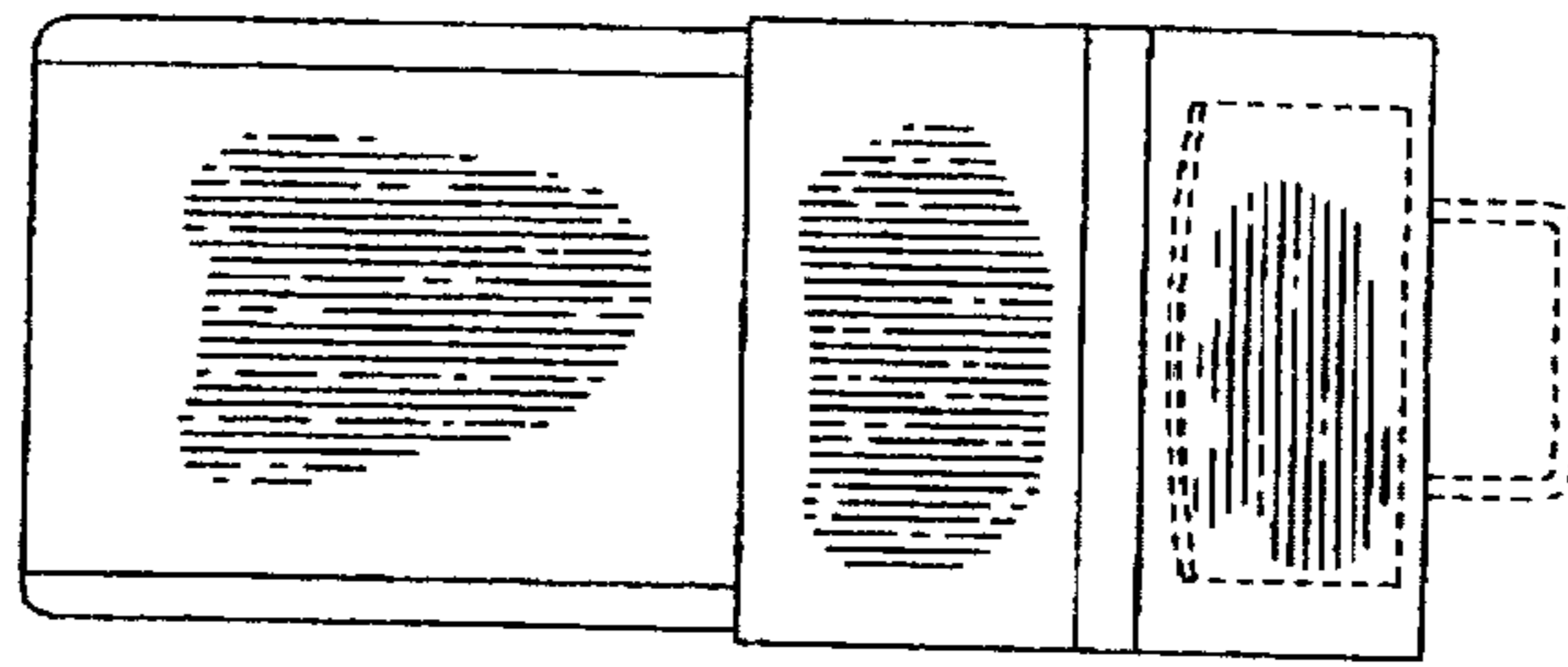

Fig. 10

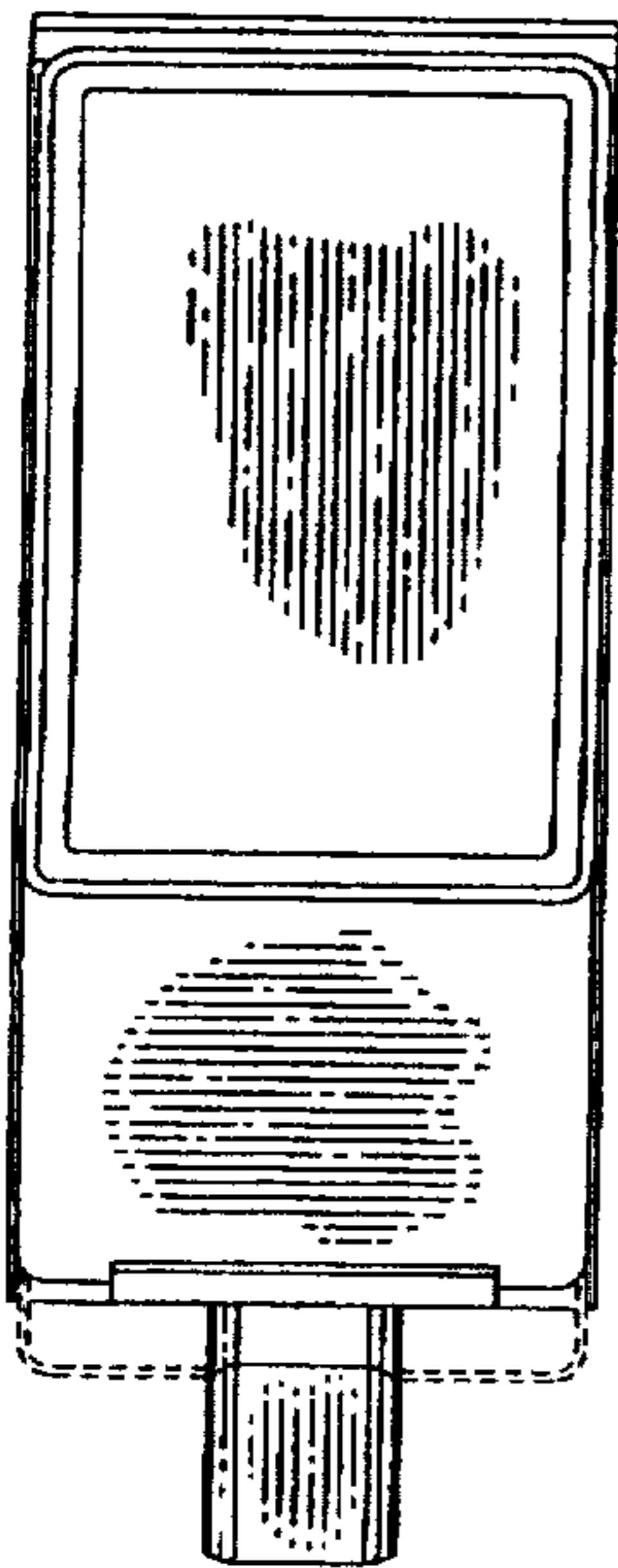

Fig. 7

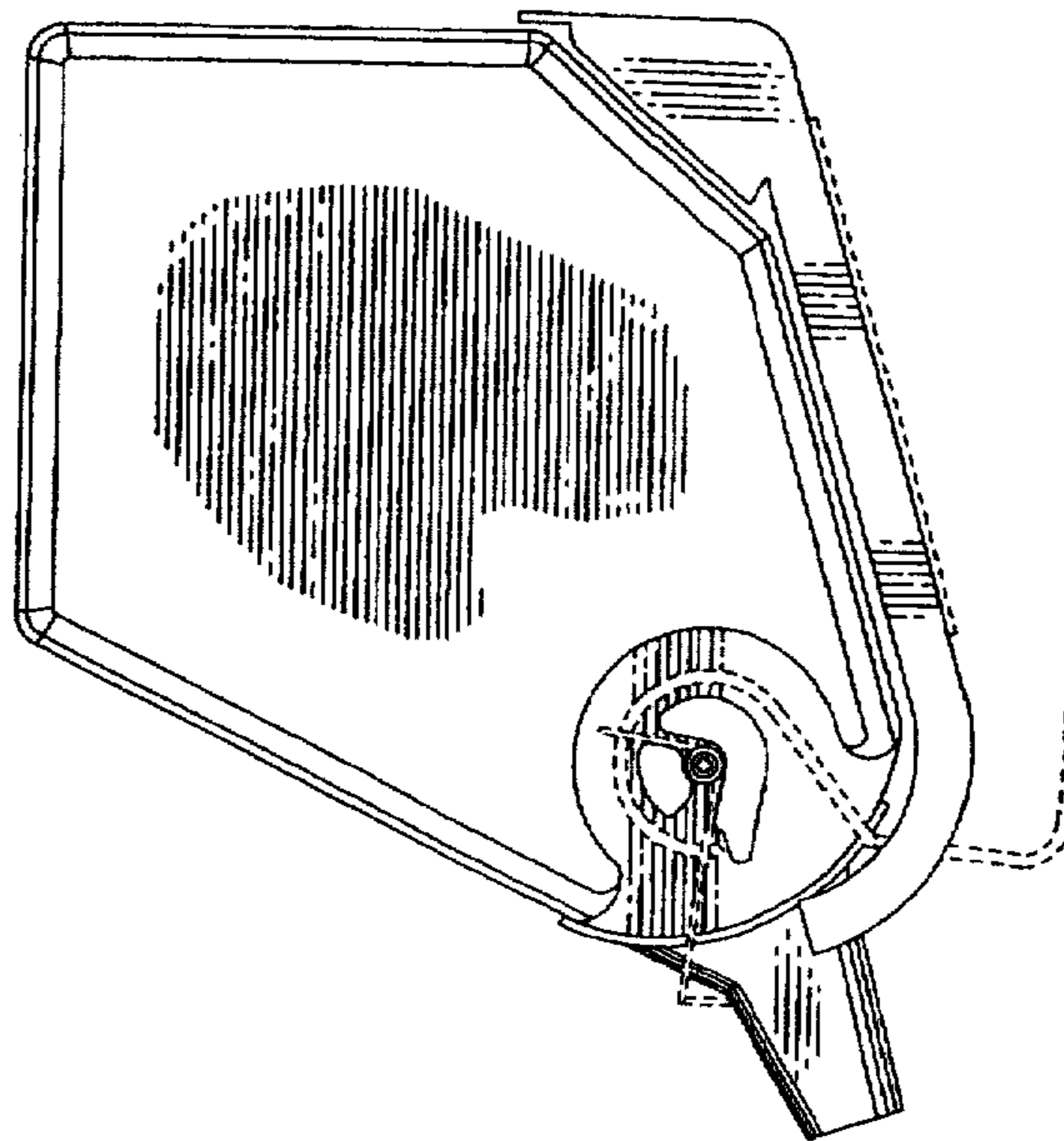

Fig. 8

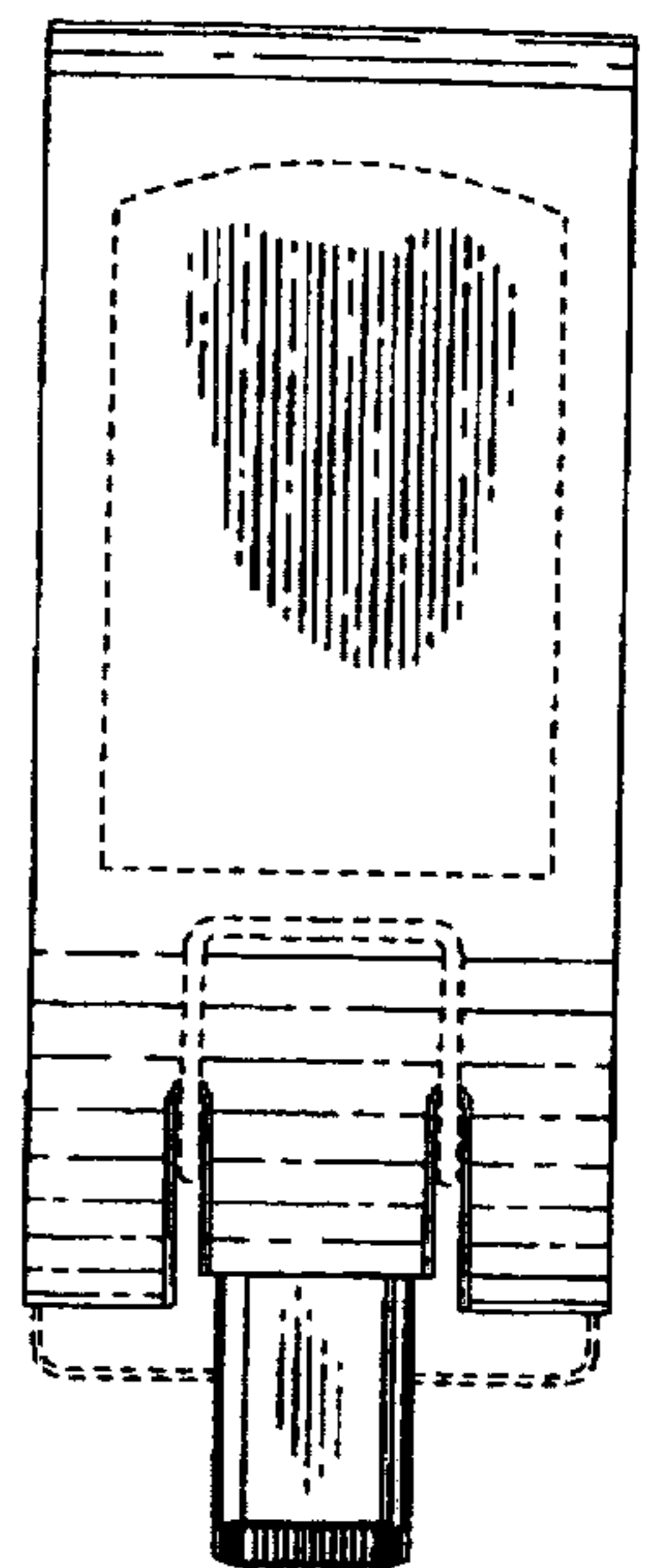

Fig. 9

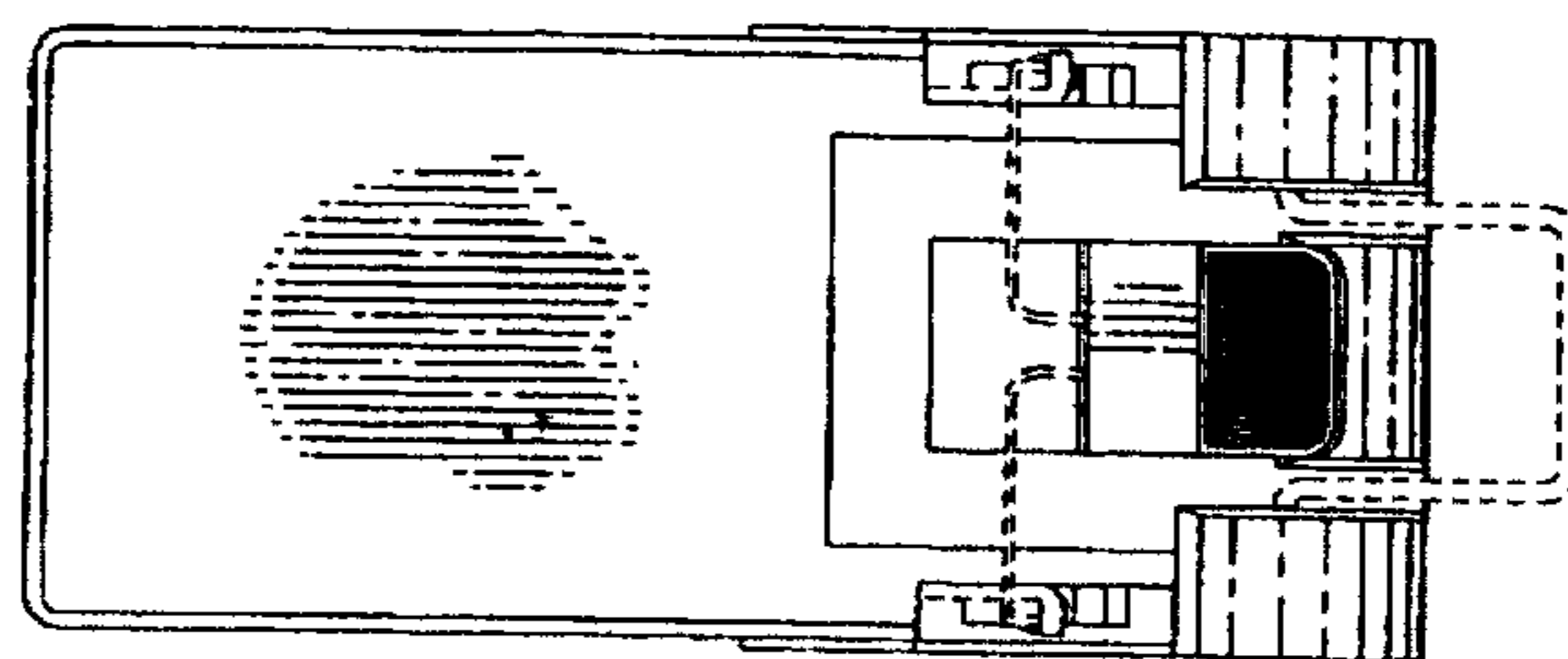

Fig. 11