



US00D421531S

United States Patent [19] Haas

[11] **Patent Number: Des. 421,531**
[45] **Date of Patent: ** Mar. 14, 2000**

[54] **SHOE RACK**

[76] **Inventor: Grover J. Haas, 4606 Navaho Dr., Pascagoula, Miss. 39581**

[**] **Term: 14 Years**

[21] **Appl. No.: 29/083,912**

[22] **Filed: Feb. 18, 1998**

[51] **LOC (6) Cl. 06-04**

[52] **U.S. Cl. D6/411; D6/462**

[58] **Field of Search D6/411, 462, 463, D6/464, 466, 467, 468; 211/34-38, 181.1, 182; 312/107**

- 4,008,807 2/1977 Phillips .
- 4,168,871 9/1979 Dierkes .
- 4,376,486 3/1983 Arcadi, Jr. .
- 5,127,528 7/1992 Cone .
- 5,423,435 6/1995 Pollard et al. .
- 5,636,751 6/1997 Frank .

Primary Examiner—Doris V. Coles
Assistant Examiner—Linda Brooks
Attorney, Agent, or Firm—Chase & Yakimo, L.C.

[57] CLAIM

The ornamental design for a shoe rack, as shown and described.

DESCRIPTION

FIG. 1 is a front perspective view showing my new design from the left corner thereof;
FIG. 2 is a top view of FIG. 1;
FIG. 3 is a bottom view of FIG. 1;
FIG. 4 is a front view of FIG. 1;
FIG. 5 is a rear view of FIG. 1;
FIG. 6 is an enlarged right side view of FIG. 1; and,
FIG. 7 is an enlarged left side view of FIG. 1.

[56] References Cited

U.S. PATENT DOCUMENTS

Re. 34,570	3/1994	Fromkin .	
D. 122,929	10/1940	Seltzer	D6/411
D. 283,570	4/1986	Penner	D6/464
D. 324,139	2/1992	Frazier	D6/411
D. 384,224	9/1997	Dickinson et al.	D6/411 X
D. 403,880	1/1999	Malik	D6/411
3,788,241	1/1974	Ravreby .	

1 Claim, 7 Drawing Sheets

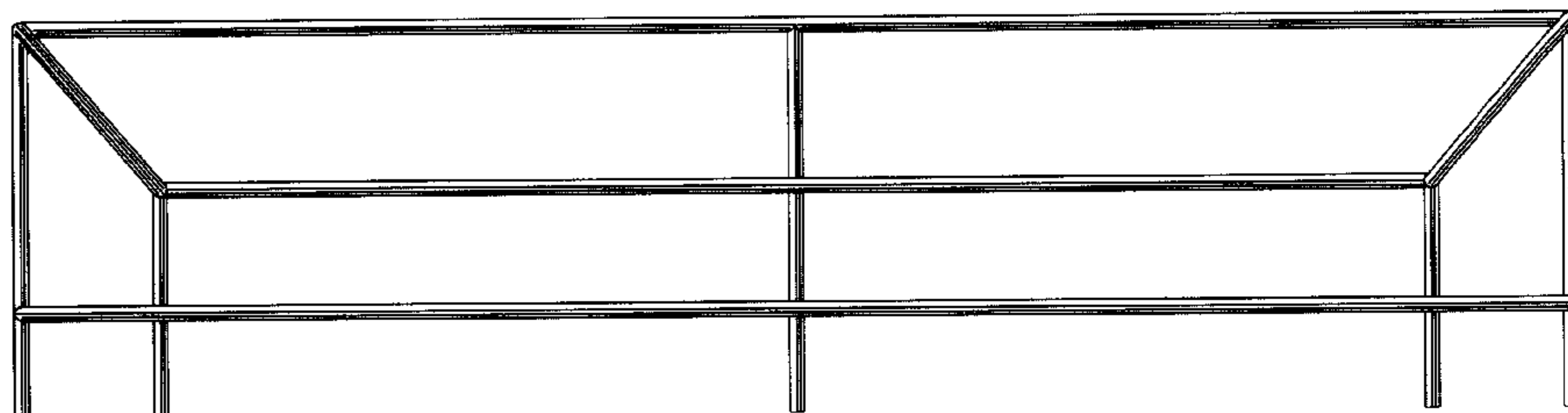
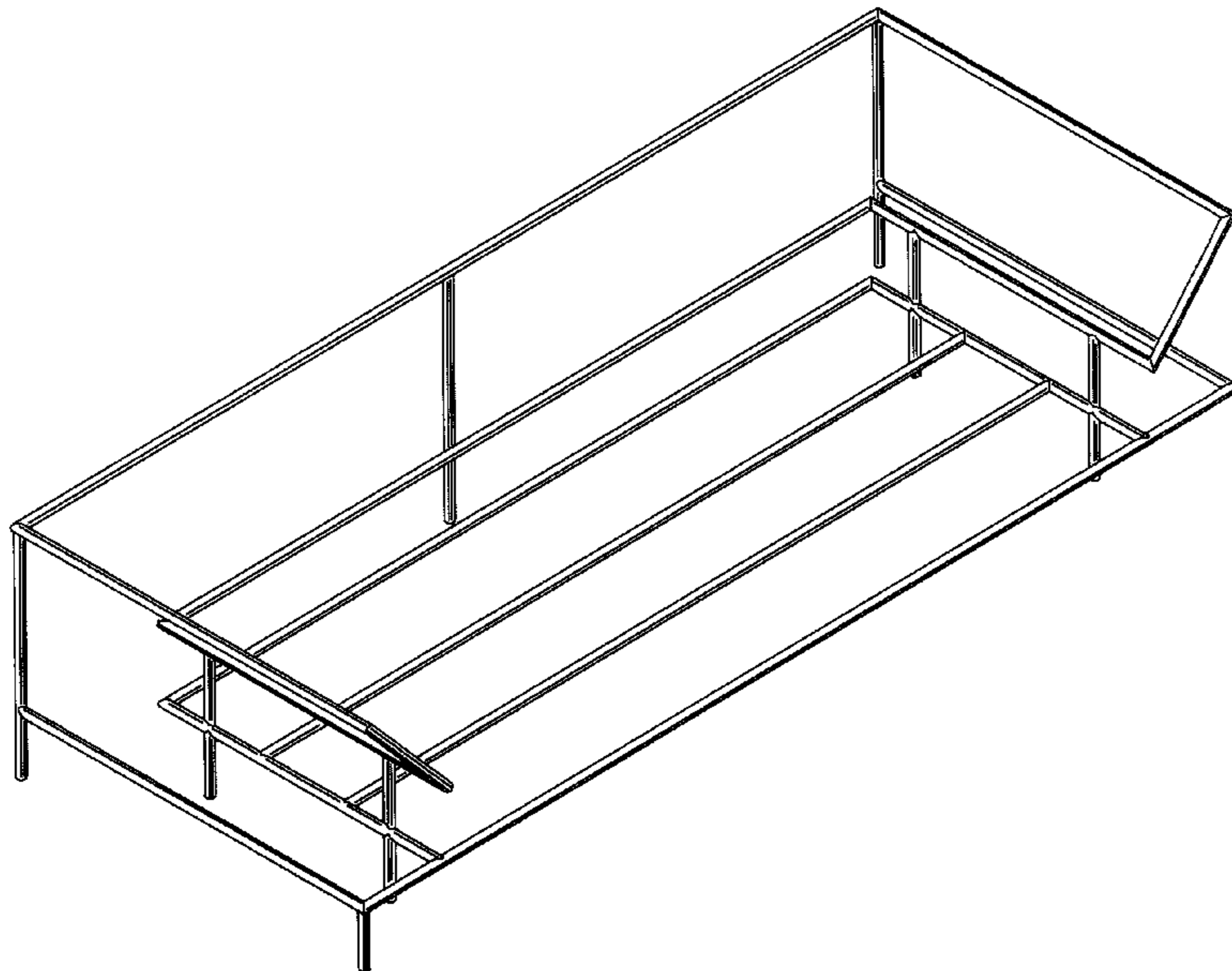

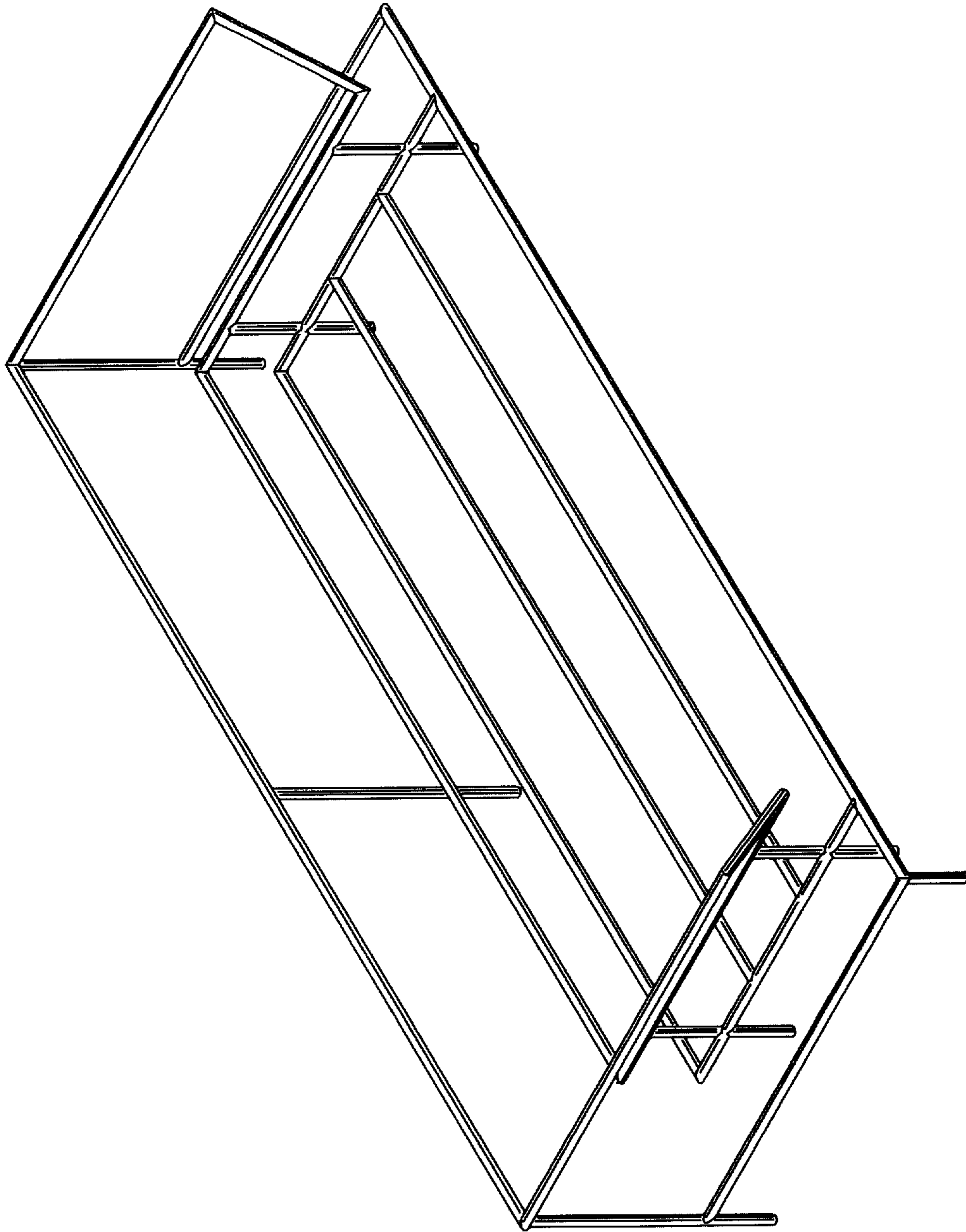

FIG. 1

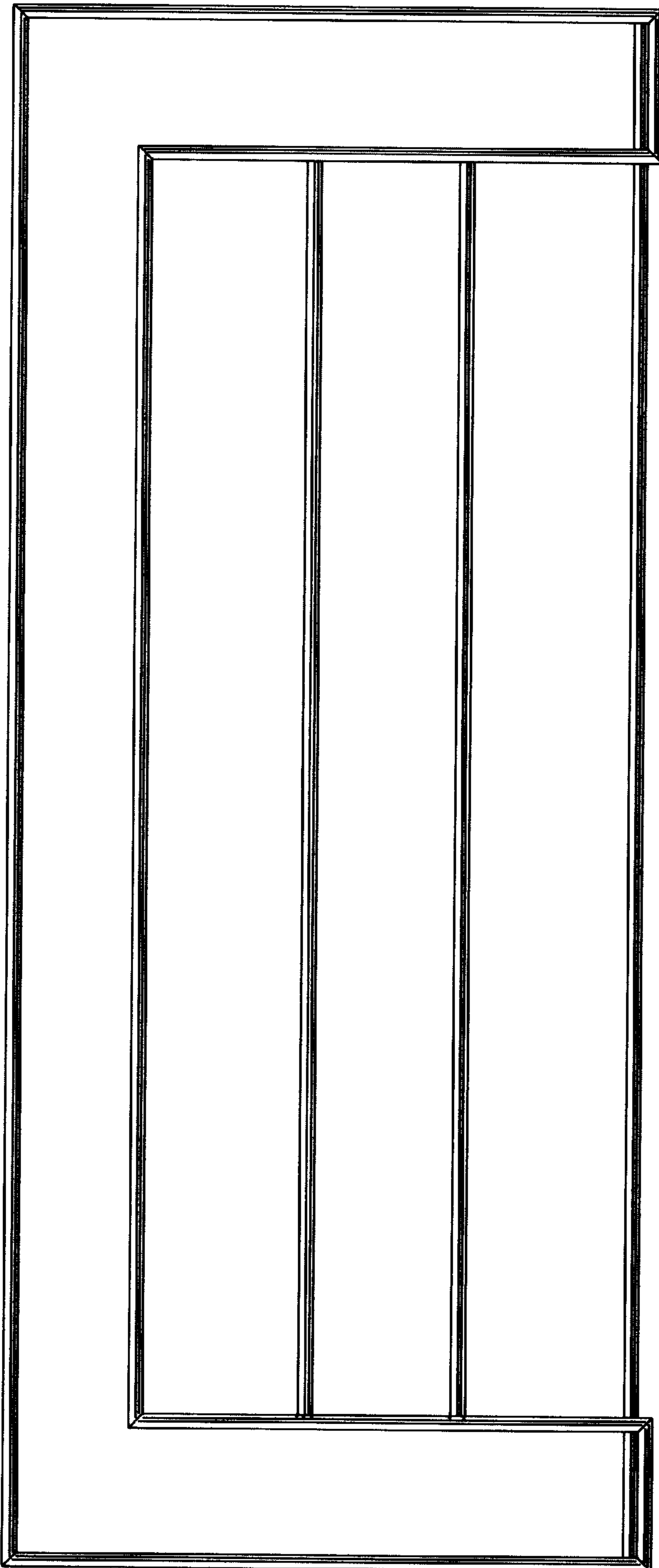

FIG. 2

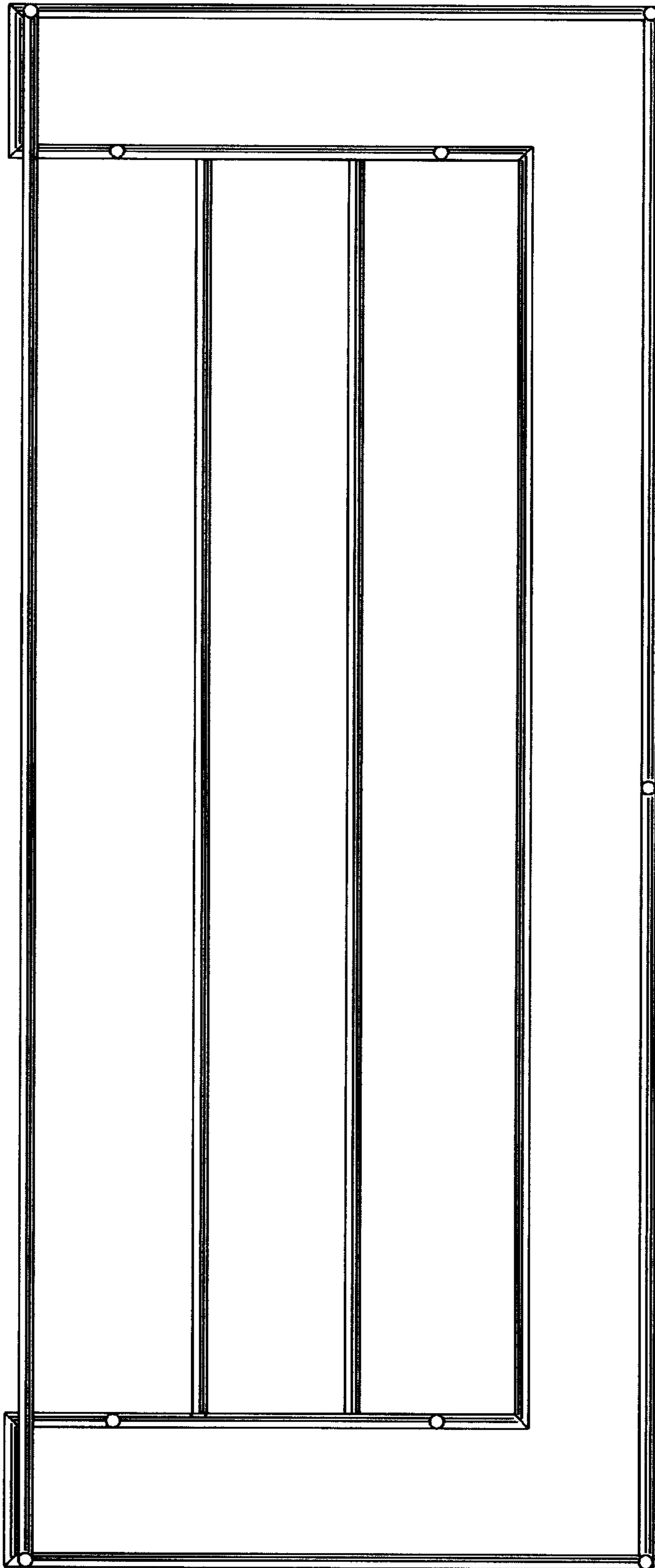

FIG. 3

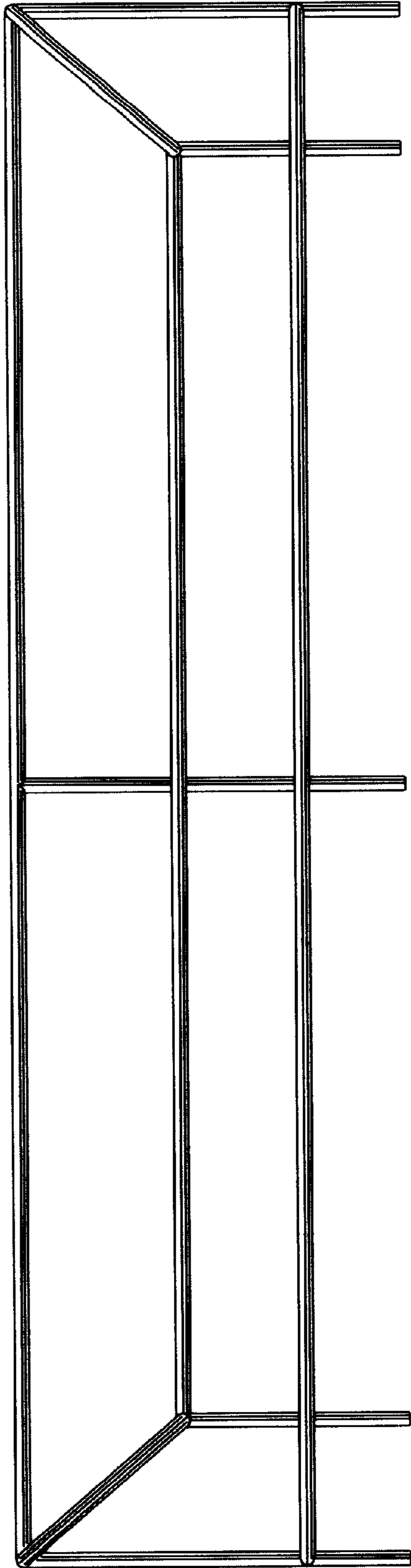

FIG. 4

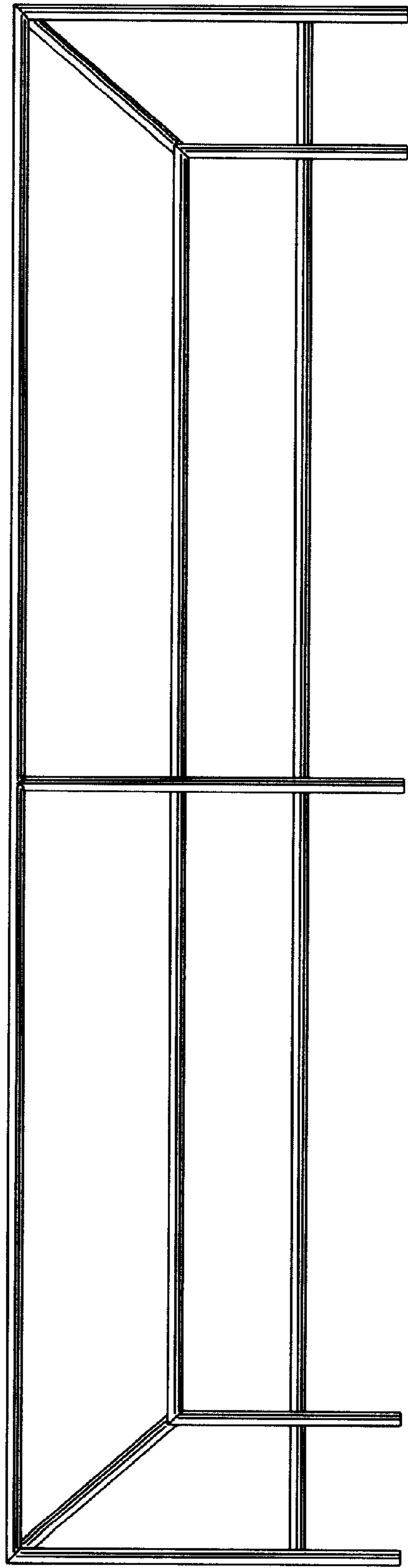

FIG. 5

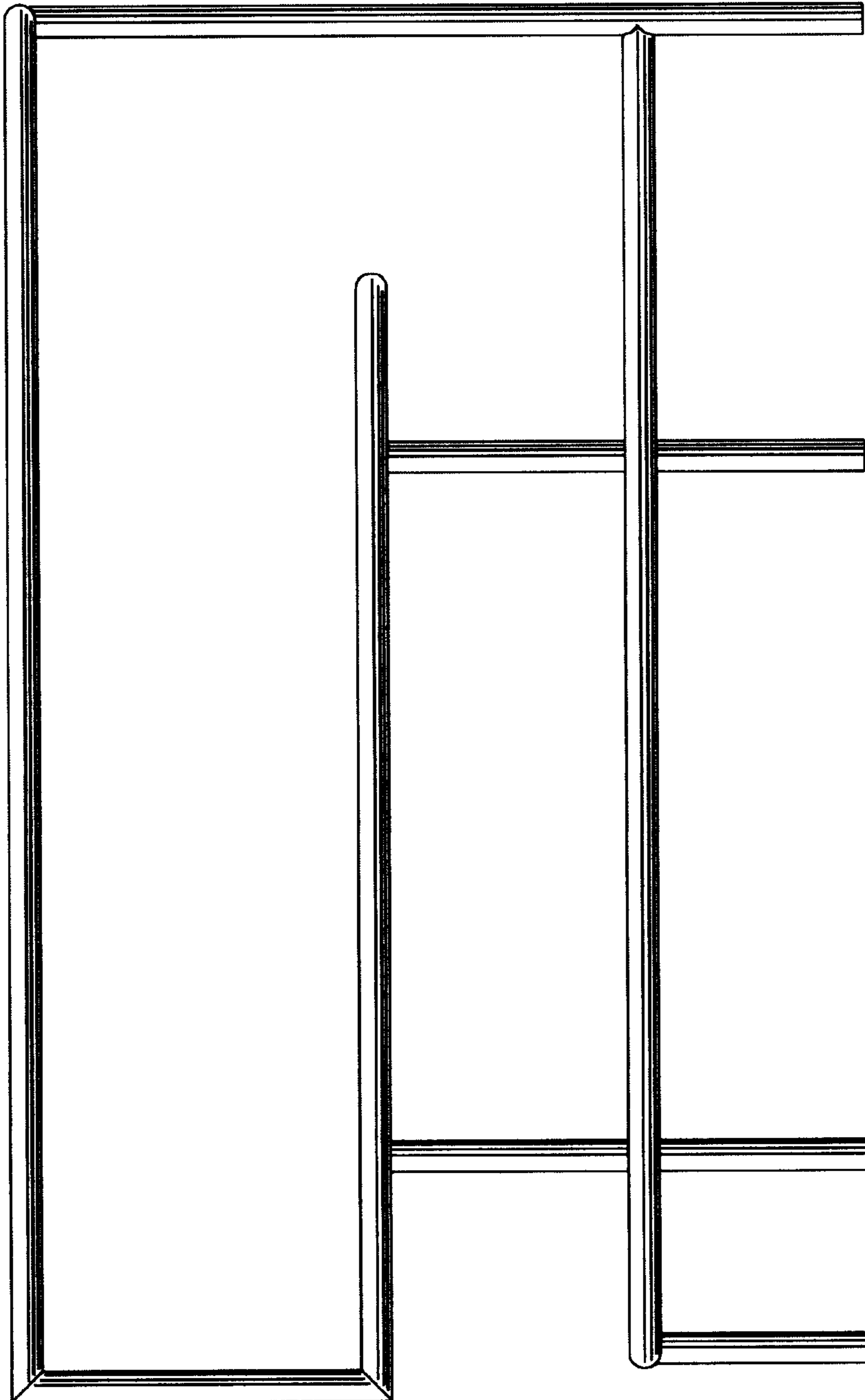

FIG. 6

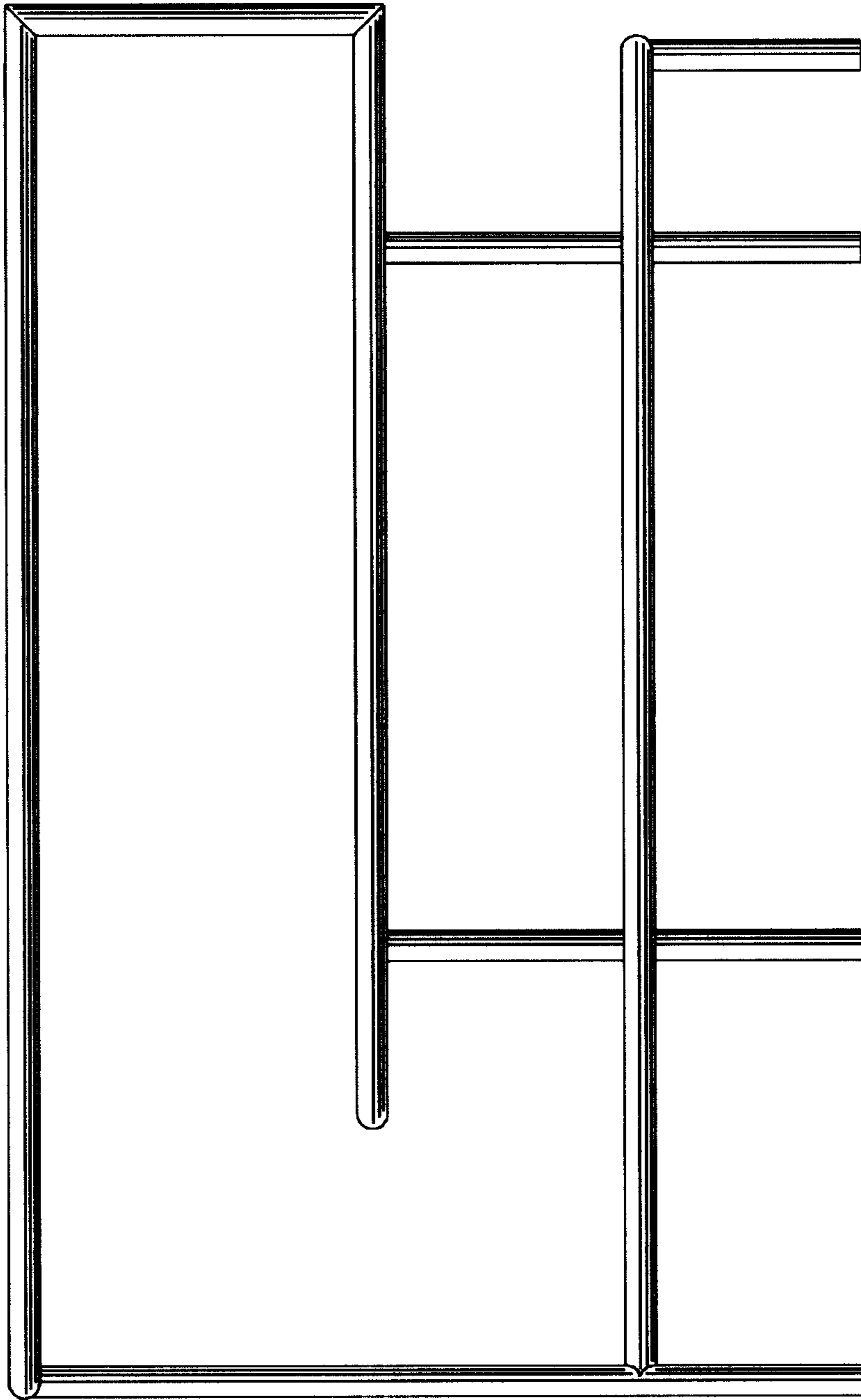

FIG. 7