



US00D421480S

United States Patent [19] Edwards

[11] **Patent Number: Des. 421,480**
[45] **Date of Patent: ** Mar. 7, 2000**

[54] **FISH LURE**

4,930,248 6/1990 Owens D22/144
5,600,917 2/1997 Manno 43/44.82

[76] Inventor: **William E. Edwards**, 609 Montana Ave., Libby, Mont. 59923

Primary Examiner—Louis S. Zarfaz
Assistant Examiner—Inga-Maria Hyttinen
Attorney, Agent, or Firm—Goldstein & Canino

[**] Term: **14 Years**

[21] Appl. No.: **29/101,370**

[57] **CLAIM**

[22] Filed: **Mar. 1, 1999**

The ornamental design for a fish lure, as shown and described.

[51] **LOC (6) Cl.** **22-05**

[52] **U.S. Cl.** **D22/144; D22/126**

[58] **Field of Search** D22/144, 132, D22/126, 145; 43/44.82, 43.16

DESCRIPTION

[56] **References Cited**

FIG. 1 is a diagrammatic perspective view of the fish lure. FIG. 2 is a front elevational view thereof. FIG. 3 is a rear elevational view thereof. FIG. 4 is a left side elevational view thereof, the right side elevational view being a mirror image thereof. FIG. 5 is a top plan view of the fish lure; and, FIG. 6 is a bottom plan view thereof.

U.S. PATENT DOCUMENTS

961,259 6/1910 Reither 43/44.82
2,490,583 12/1949 Dunkelberger 43/44.82
2,492,557 12/1949 Deimler 43/44.82
2,514,527 7/1950 Verhota 43/43.16

1 Claim, 3 Drawing Sheets

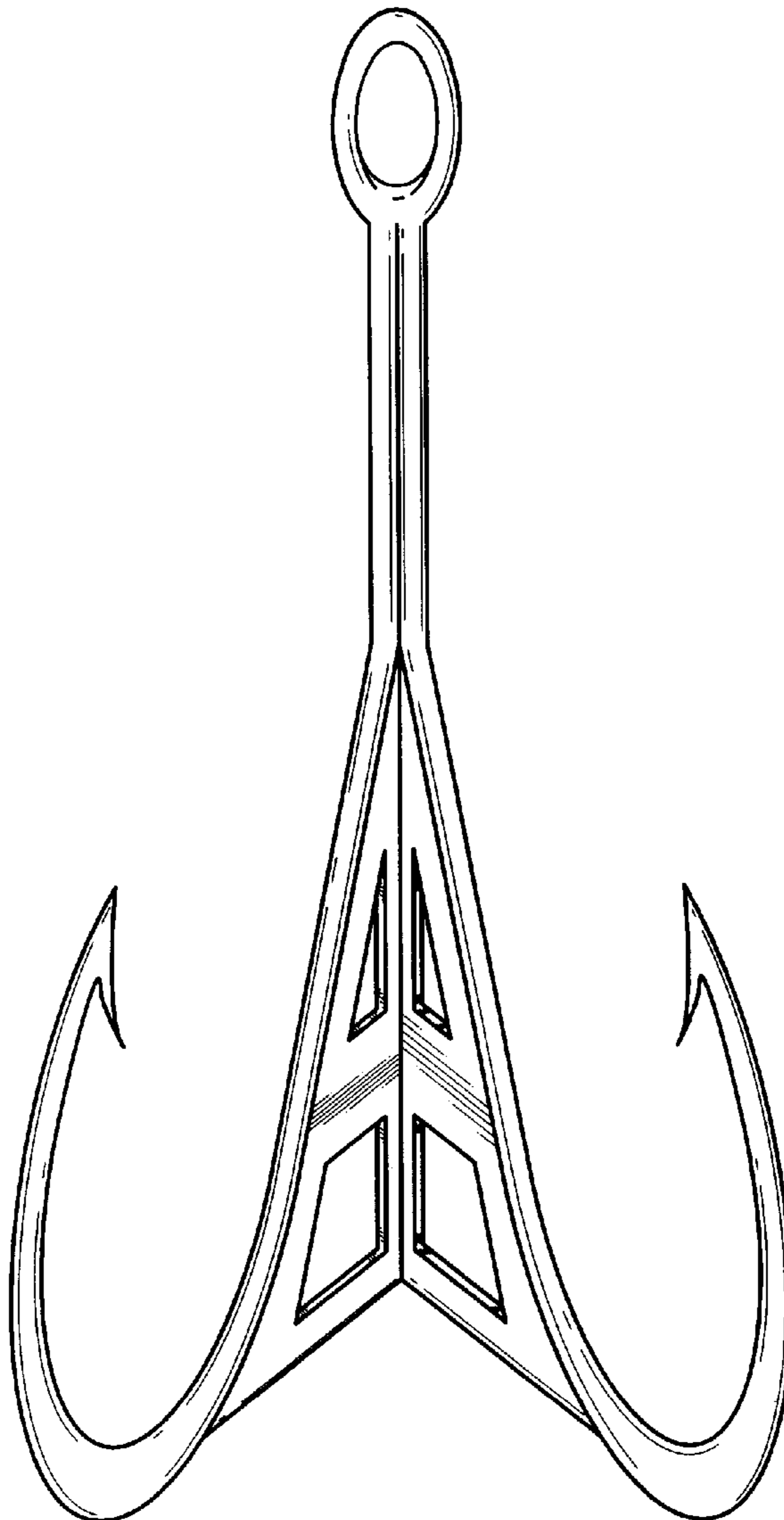

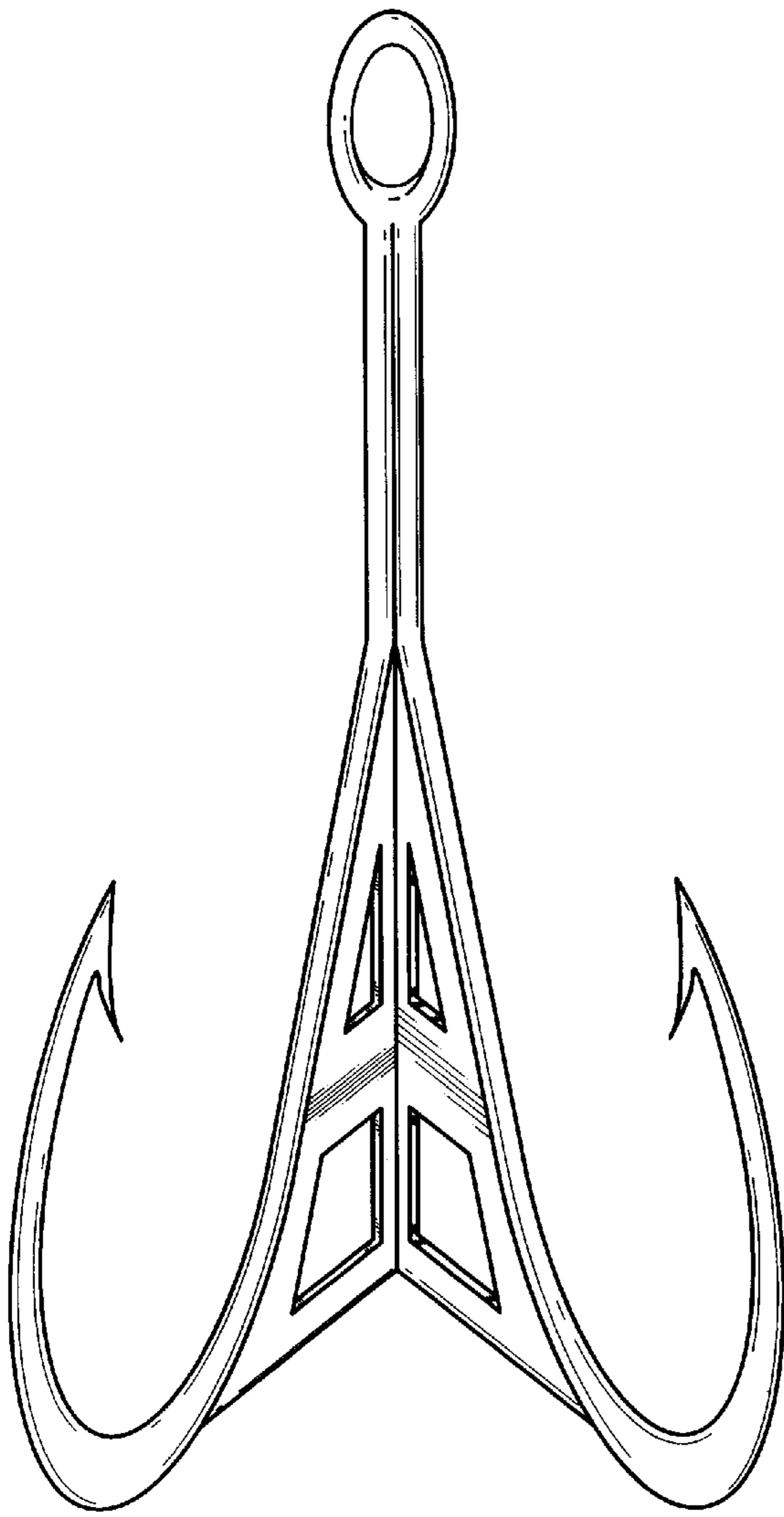

FIG. 1

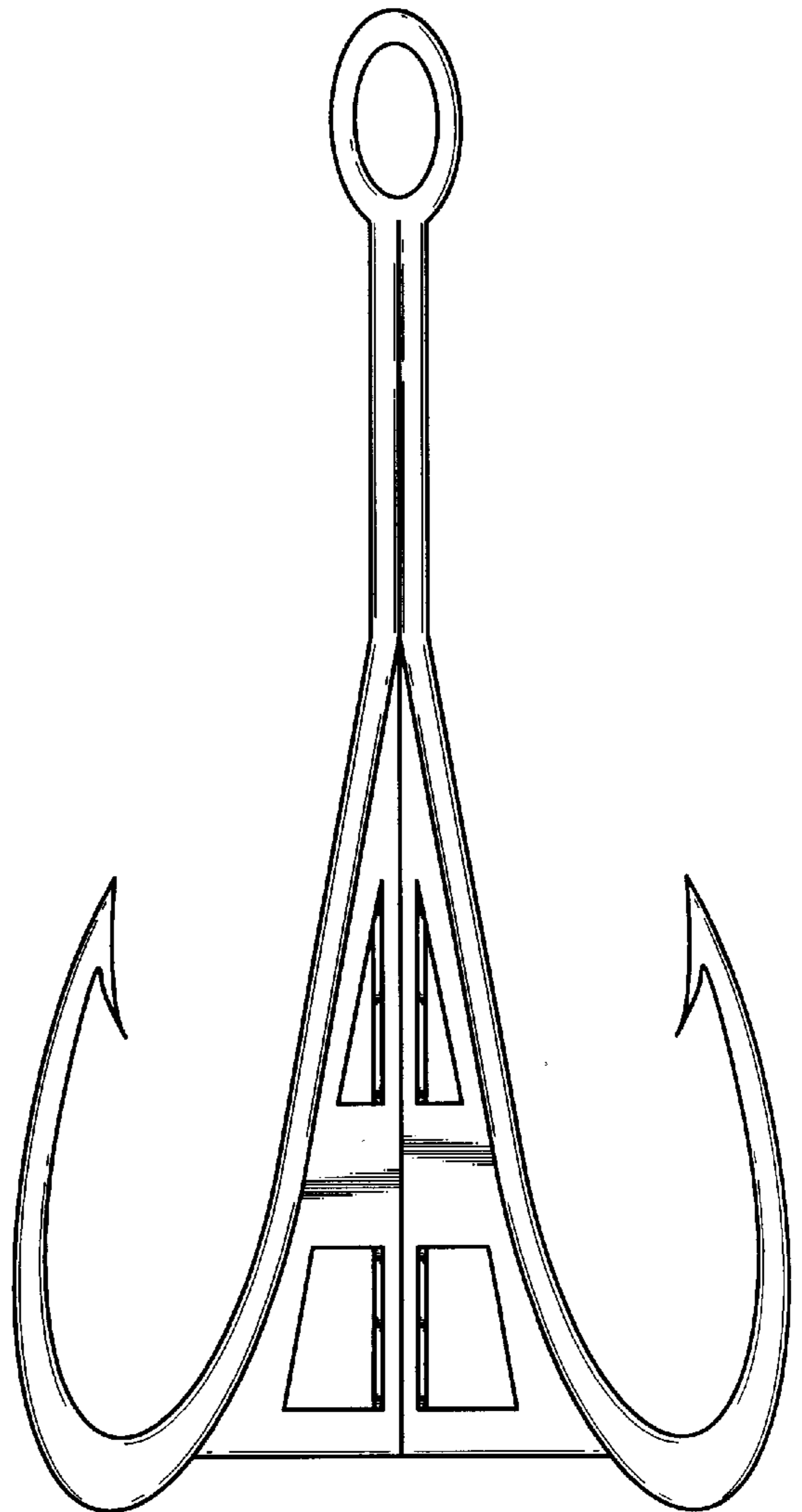

FIG. 2

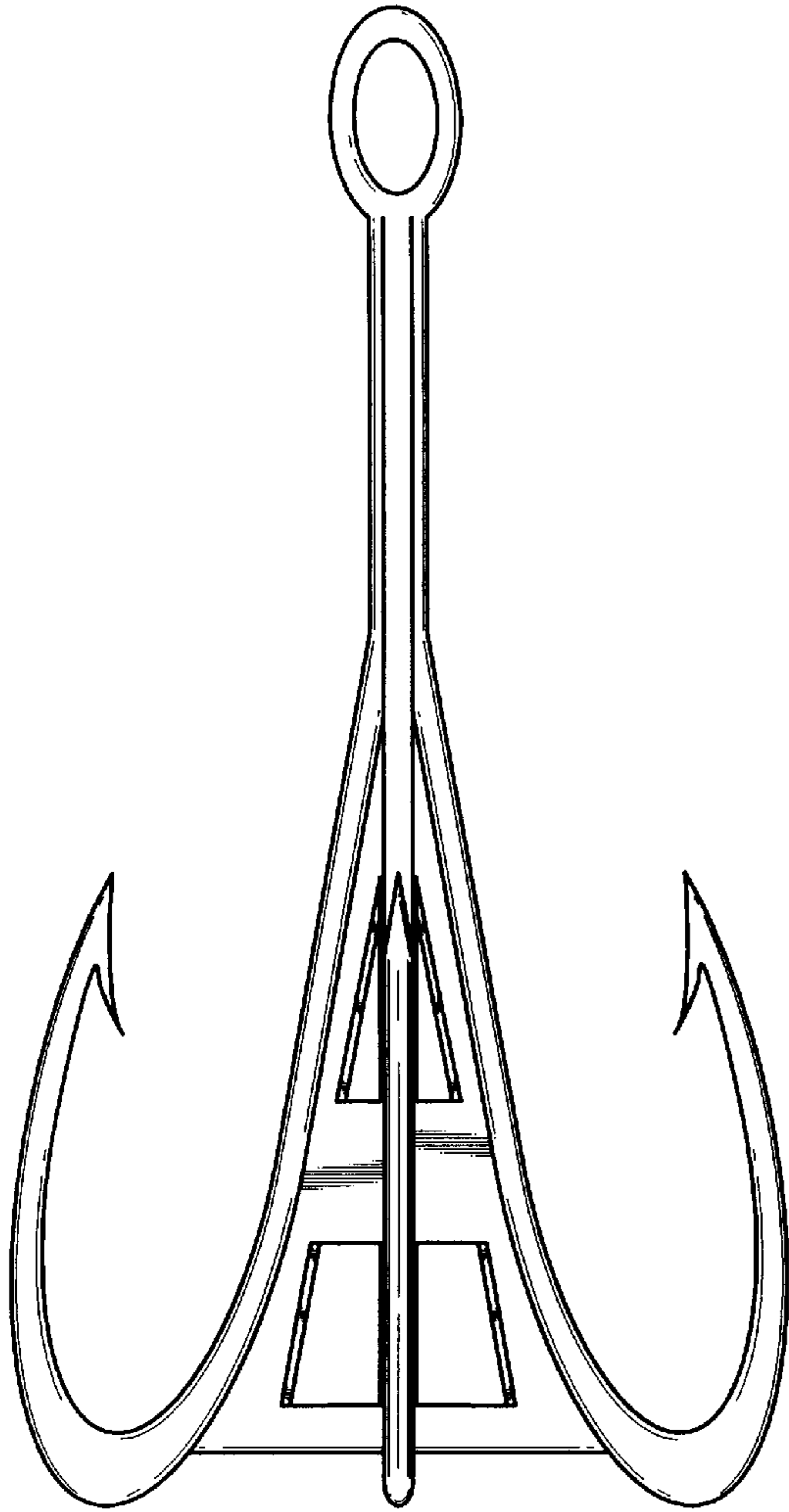

FIG. 3

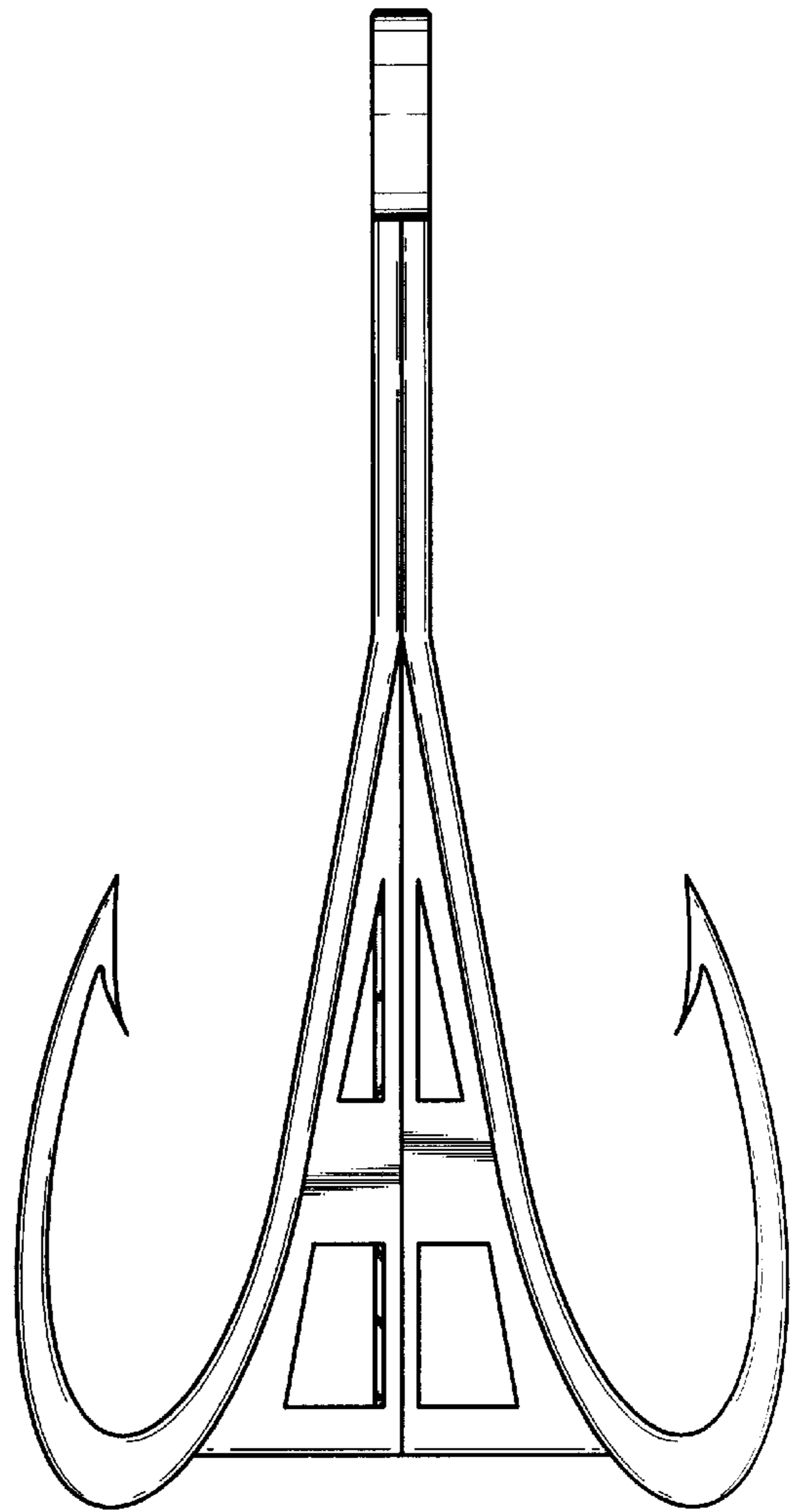

FIG. 4

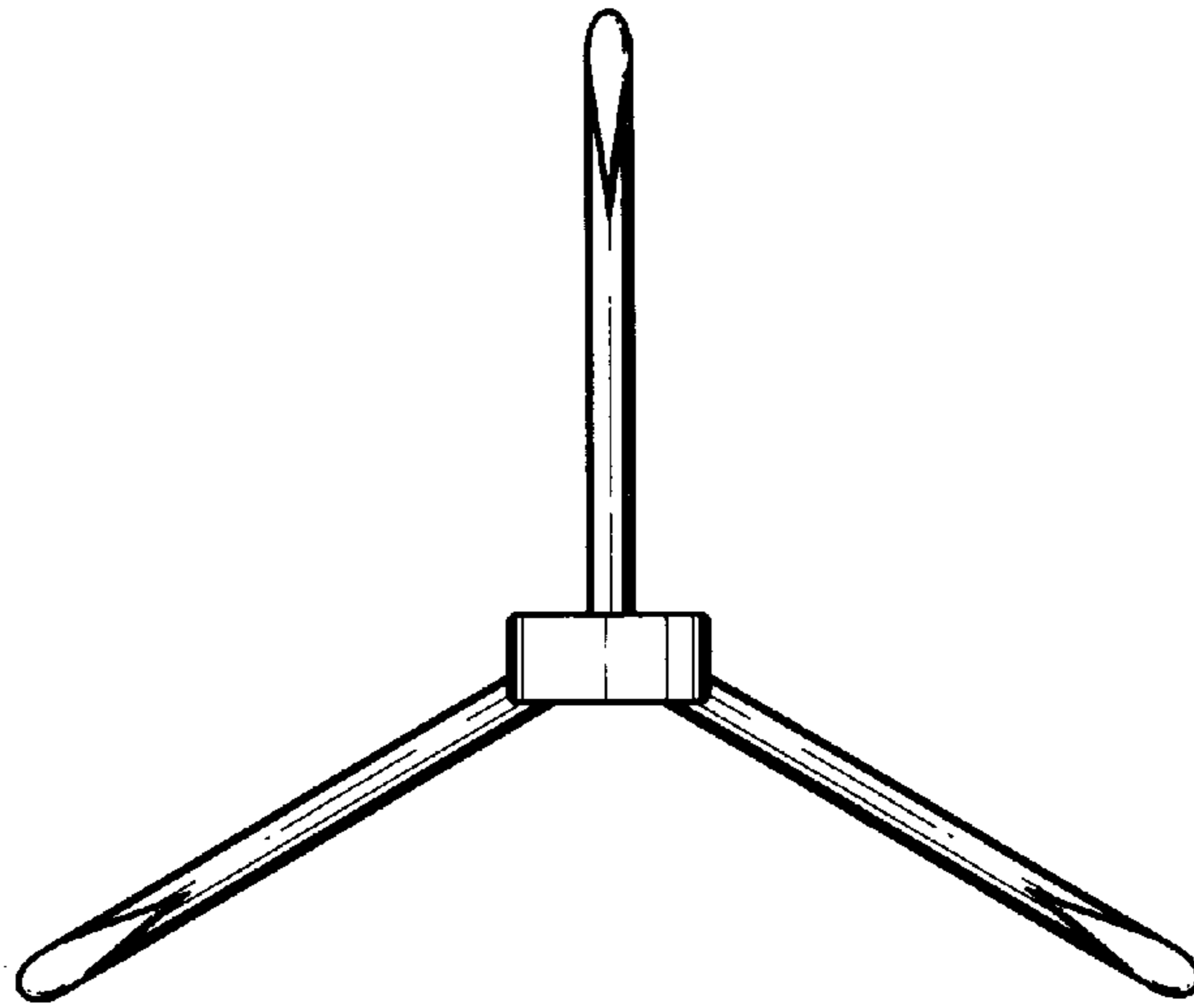

FIG. 5

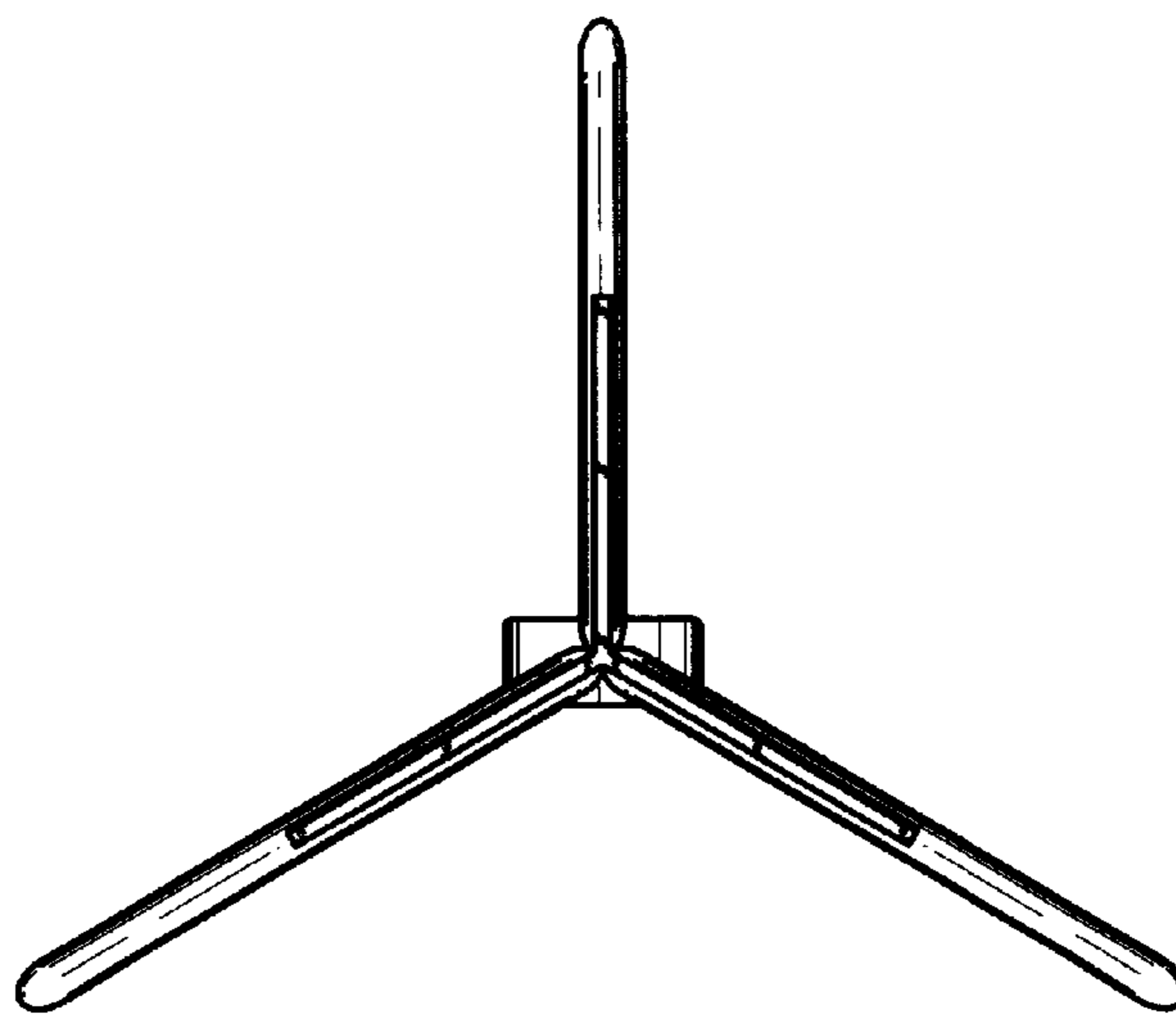

FIG. 6