



US00D421464S

**United States Patent** [19]  
**Risolia**

[11] **Patent Number: Des. 421,464**

[45] **Date of Patent: \*\* Mar. 7, 2000**

[54] **VENDING MACHINE**

2,668,636 2/1954 Martin ..... D20/1 X

[75] Inventor: **Joe Risolia**, Miami, Fla.

**OTHER PUBLICATIONS**

Sho-Rack, p. 4, Newspaper Rack, 1990.

[73] Assignee: **Intune Inc.**, Miami, Fla.

*Primary Examiner*—Nanda Bondade  
*Attorney, Agent, or Firm*—Robert M. Downey, P.A.

[\*\*] Term: **14 Years**

[21] Appl. No.: **29/104,732**

[57] **CLAIM**

[22] Filed: **May 11, 1999**

The ornamental design for a vending machine, as shown and described.

[51] **LOC (6) Cl.** ..... **20-01**

[52] **U.S. Cl.** ..... **D20/6; D20/1**

[58] **Field of Search** ..... D20/1-7; 194/225,  
194/255, 258, 272, 292, 350; 221/92, 128,  
155, 191, 194, 281

**DESCRIPTION**

FIG. 1 is a front elevational view of a vending machine showing my new design;

FIG. 2 is a rear elevational view thereof;

FIG. 3 is a left side elevational view thereof;

FIG. 4 is a right side elevational view thereof;

FIG. 5 is a top plan view thereof;

FIG. 6 is a bottom plan view thereof; and,

FIG. 7 is a perspective view thereof.

[56] **References Cited**

**U.S. PATENT DOCUMENTS**

D. 148,463	1/1948	Fuller	.....	D20/5
D. 249,294	9/1978	Housman	.....	D20/1
D. 377,052	12/1996	Woodard	.....	D20/2
D. 398,652	9/1998	Johnson	.....	D20/4

**1 Claim, 4 Drawing Sheets**

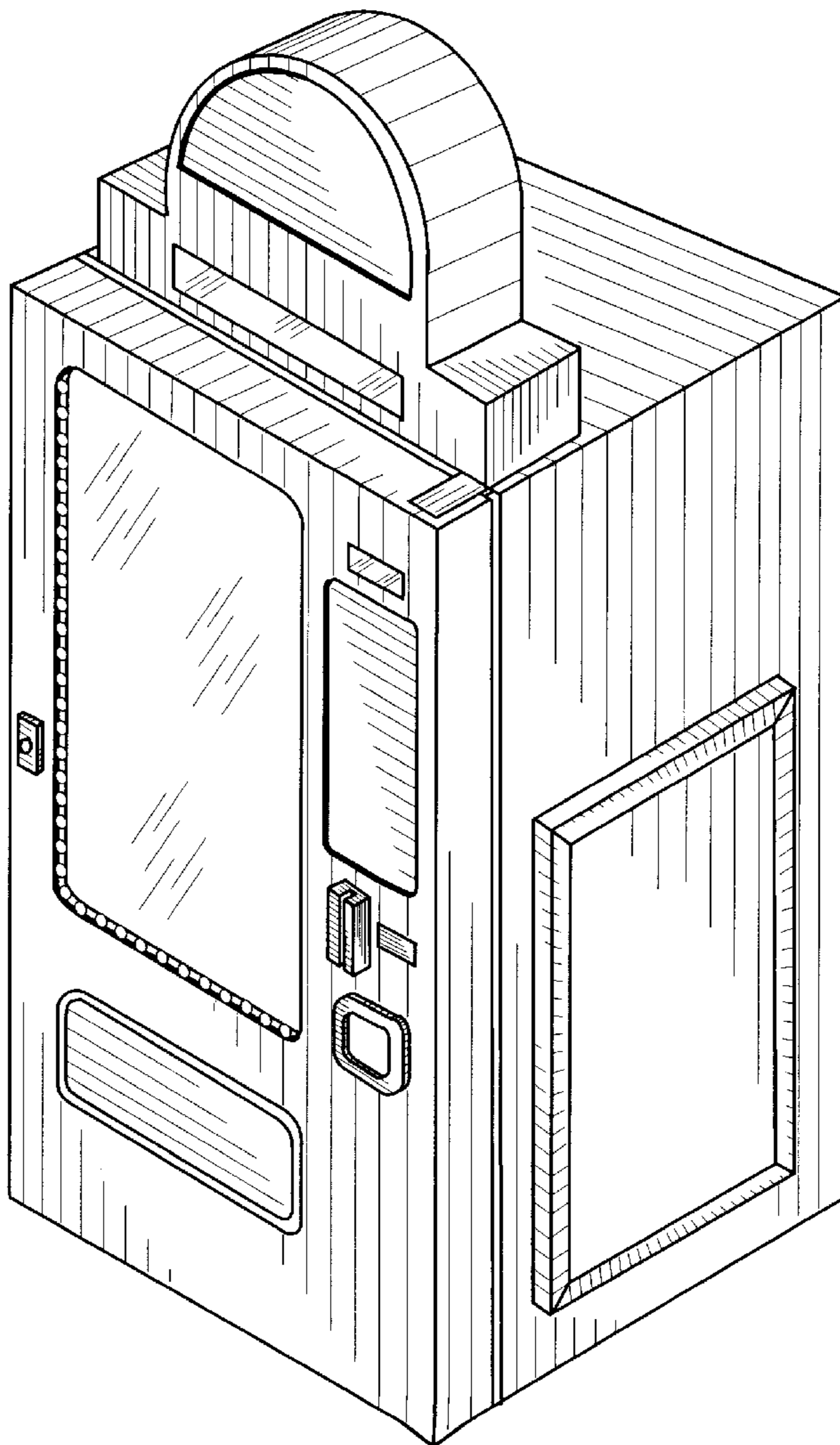

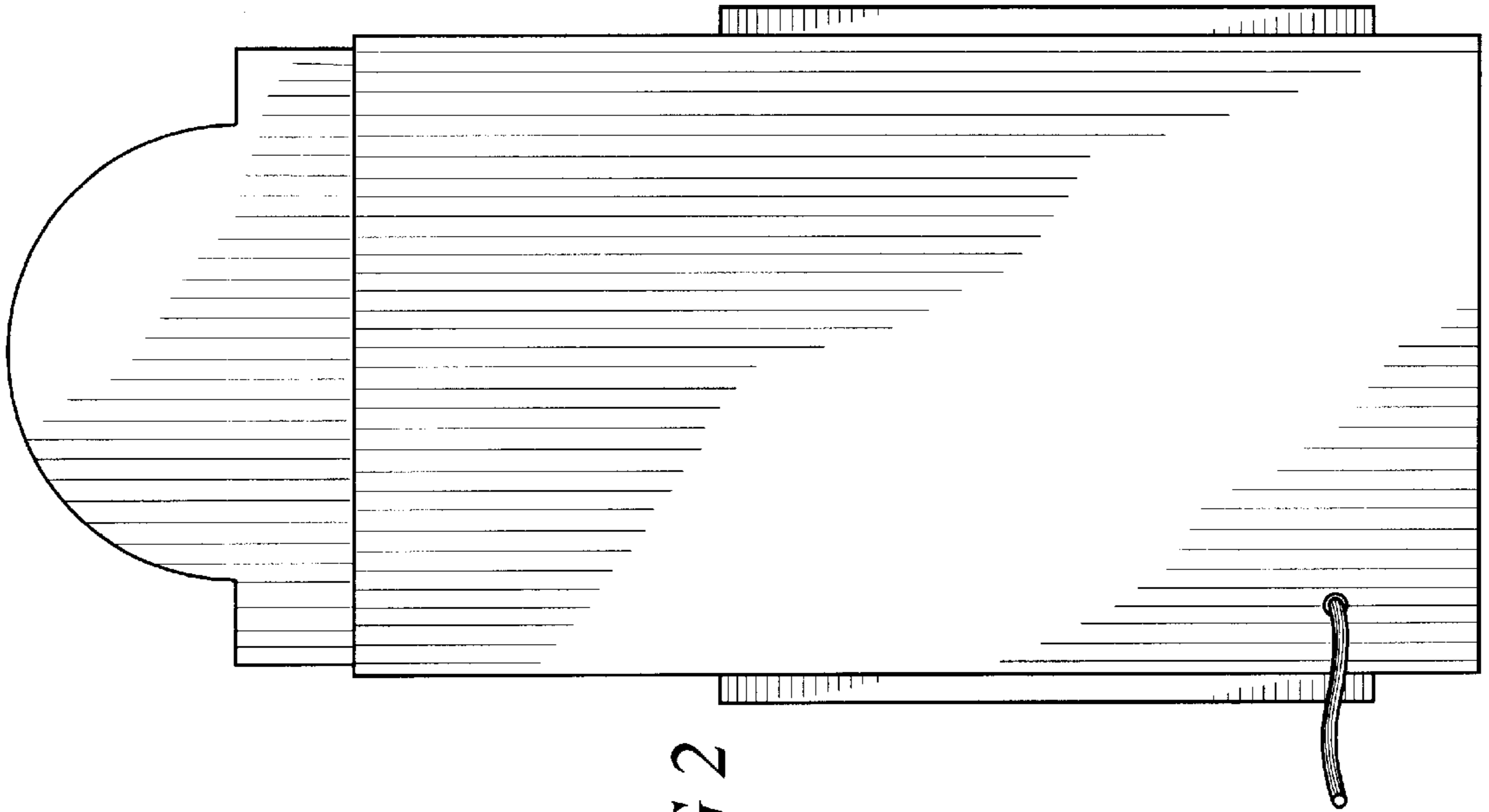

FIG 2

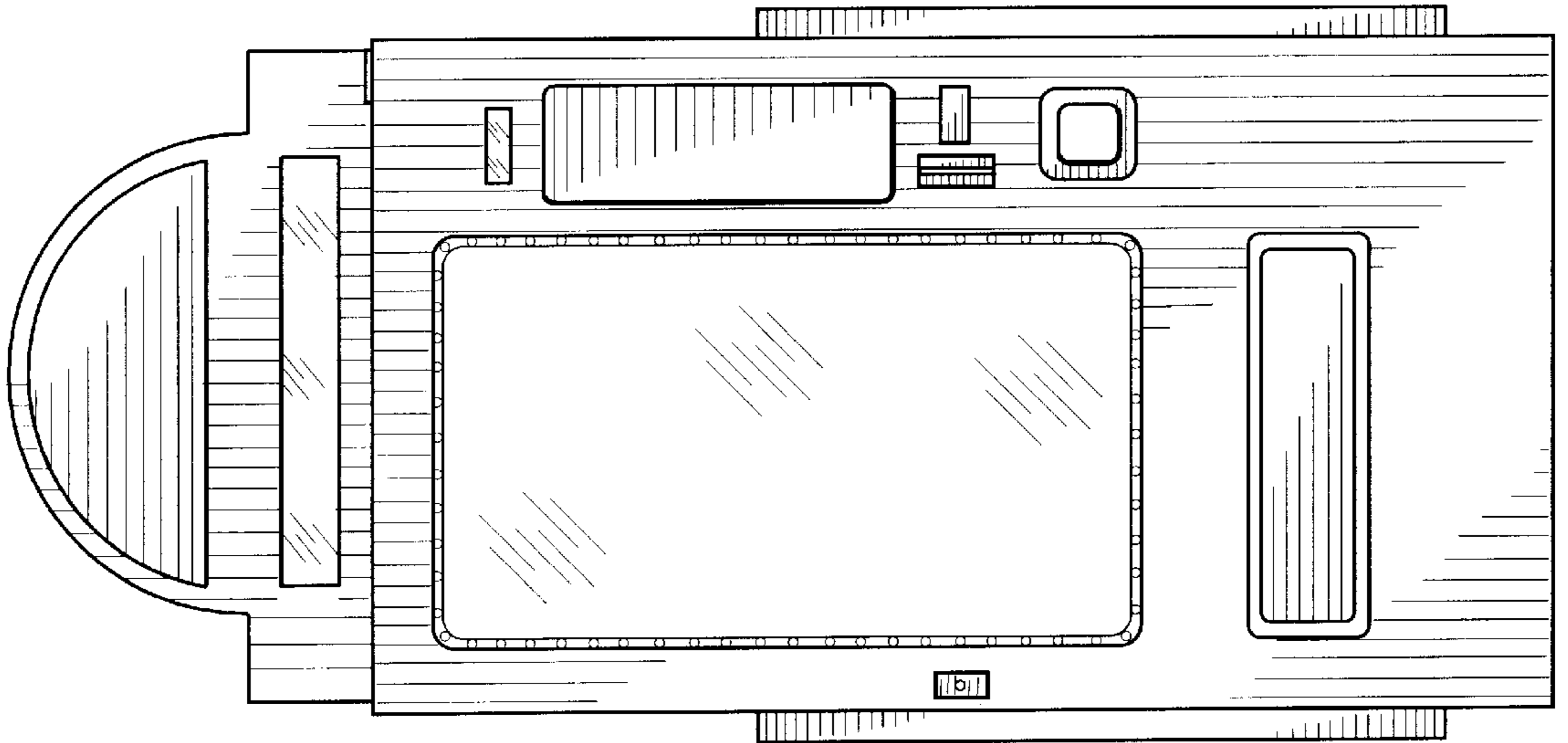

FIG 1

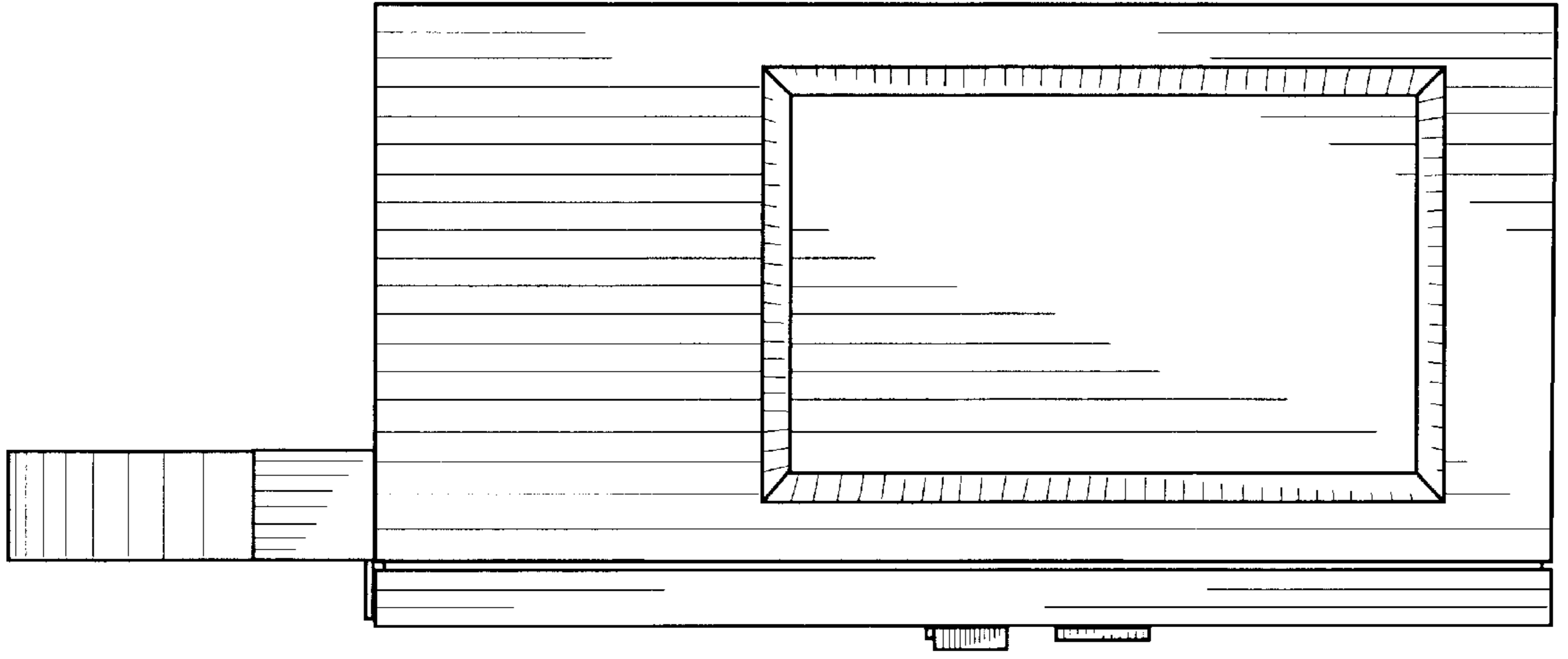

FIG 4

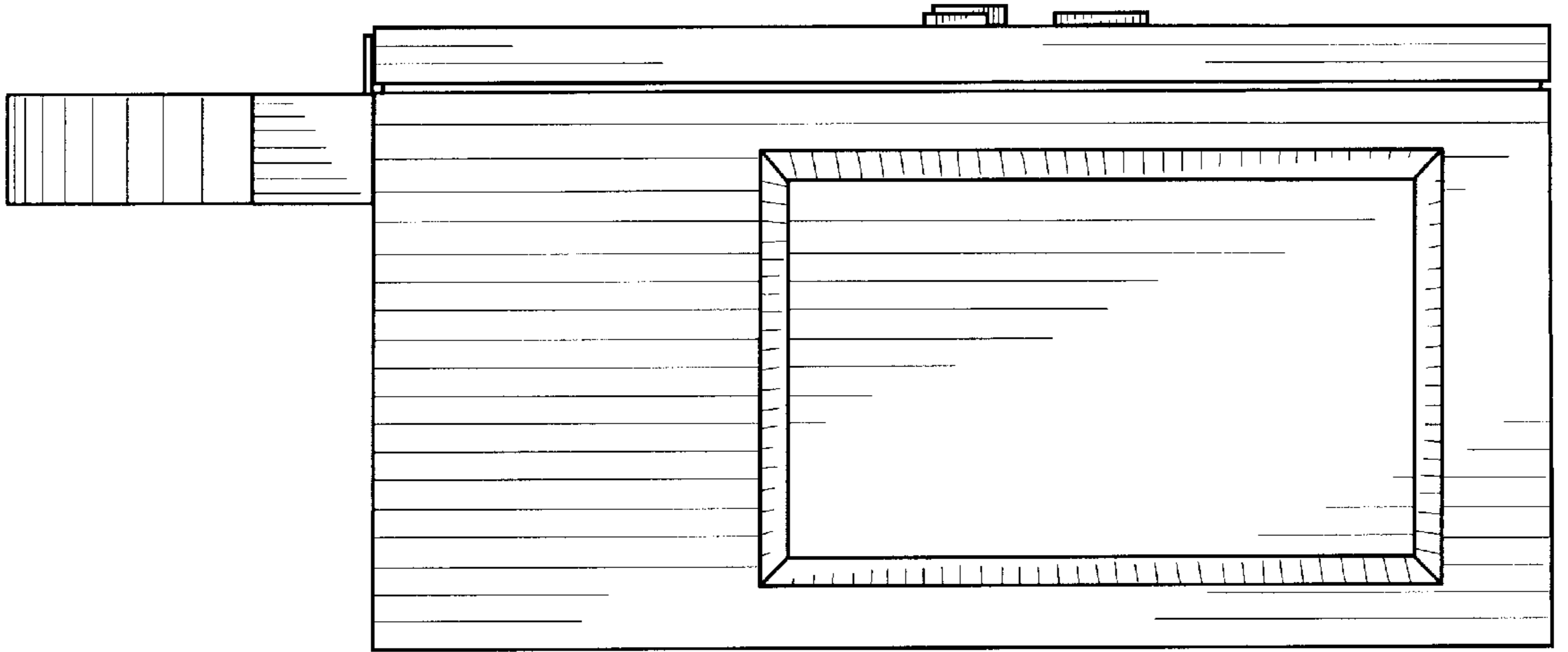

FIG 3

FIG 6

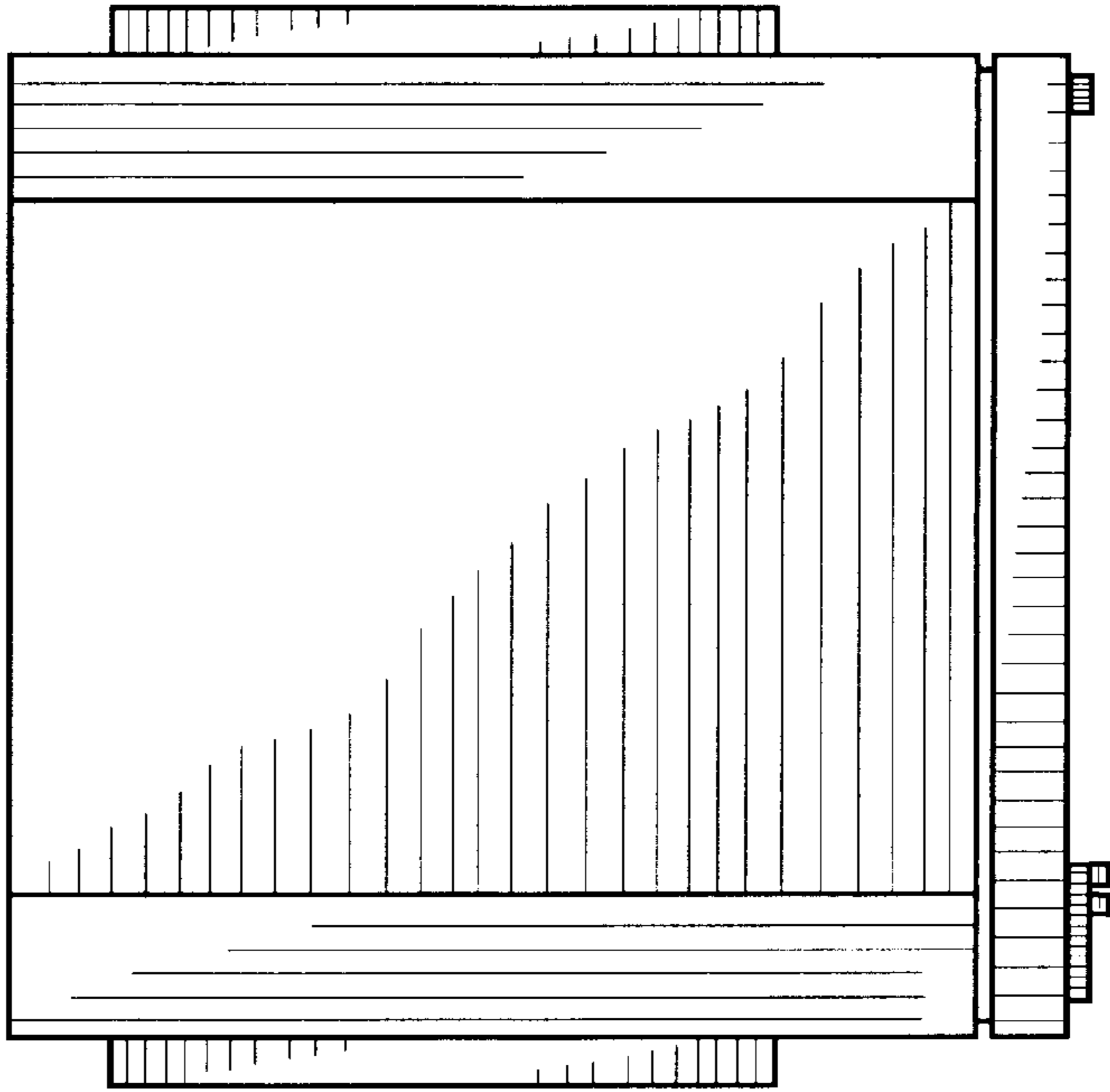
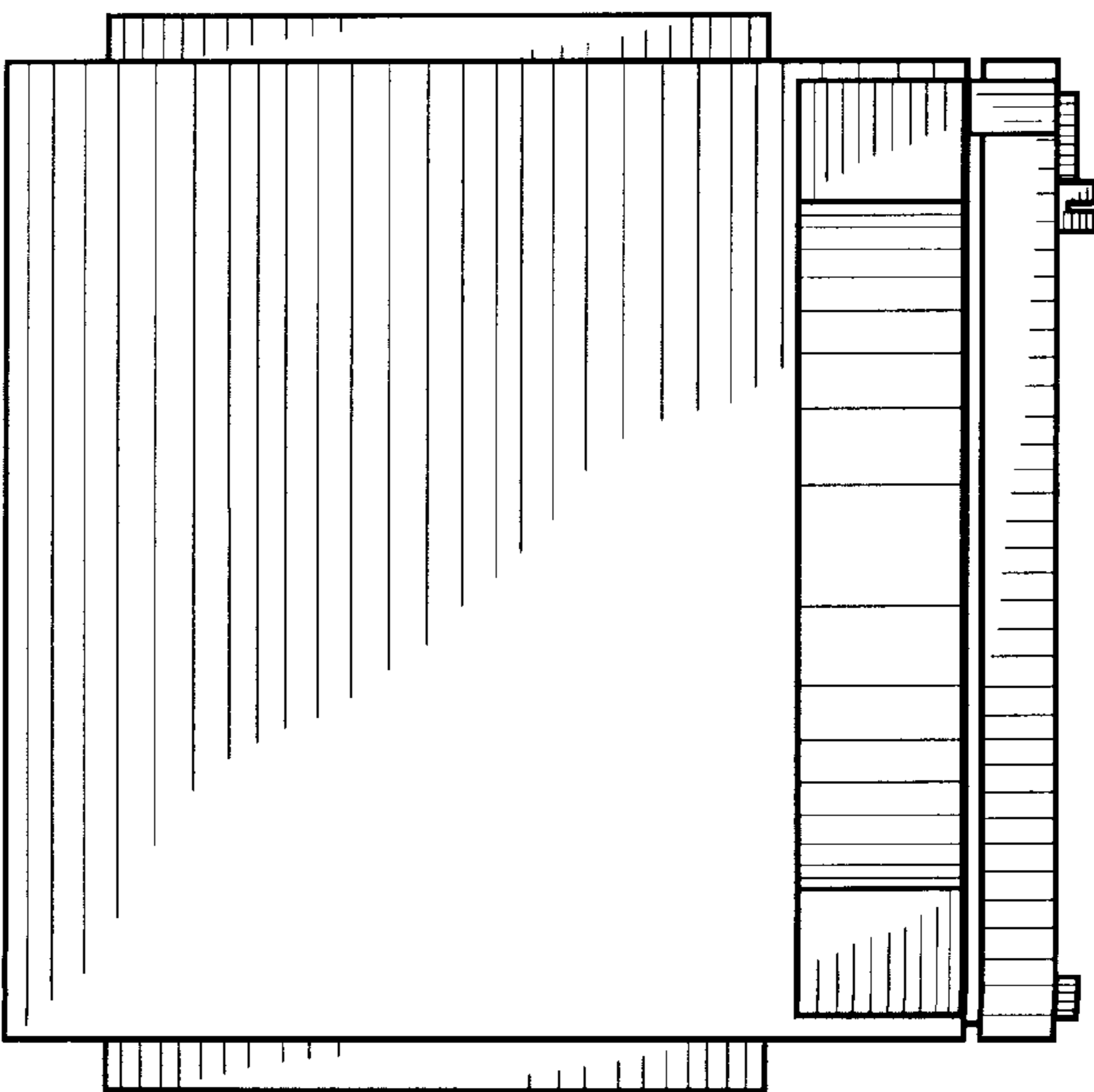

FIG 5



*FIG. 7*

