



US00D421462S

United States Patent [19] Orchanian

[11] **Patent Number: Des. 421,462**
[45] **Date of Patent: ** Mar. 7, 2000**

[54] **ACCESSORY HOLDER**

[76] Inventor: **Kevorg Orchanian**, 2555 Hillview Dr.,
Krum, Tex. 76249

[**] Term: **14 Years**

[21] Appl. No.: **29/107,415**

[22] Filed: **Jul. 2, 1999**

[51] **LOC (6) Cl.** **19-06**

[52] **U.S. Cl.** **D19/77; D19/85; D19/95**

[58] **Field of Search** D19/35, 36, 75,
D19/65, 77, 78, 81-85, 95, 99, 100; 206/214,
224, 371; 211/69.1-69.9, 70; 401/129, 195;
220/555; D7/640, 641, 637

[56] **References Cited**

U.S. PATENT DOCUMENTS

- D. 323,853 2/1992 Evenson D19/77
- D. 340,071 10/1993 Sun D19/77
- D. 377,951 2/1997 McDiarmid D19/78

- D. 391,295 2/1998 Kocon et al. D19/77
- D. 407,753 4/1999 Kwok D19/77
- 1,238,830 9/1917 Schuster et al. 401/129
- 4,305,511 12/1981 Denholtz 211/70
- 4,953,696 9/1990 Huang et al. 206/214

Primary Examiner—Martie K. Holtje
Attorney, Agent, or Firm—Larry L. Uland

[57] **CLAIM**

The ornamental design for an accessory holder, as shown and described.

DESCRIPTION

FIG. 1 is a front elevational view of an accessory holder showing the design;
FIG. 2 is a rear elevational view thereof;
FIG. 3 is a right side elevational view thereof;
FIG. 4 is a left side elevational view thereof; and,
FIG. 5 is a top elevational view thereof.
The bottom of the accessory holder is flat and unornamented.

1 Claim, 4 Drawing Sheets

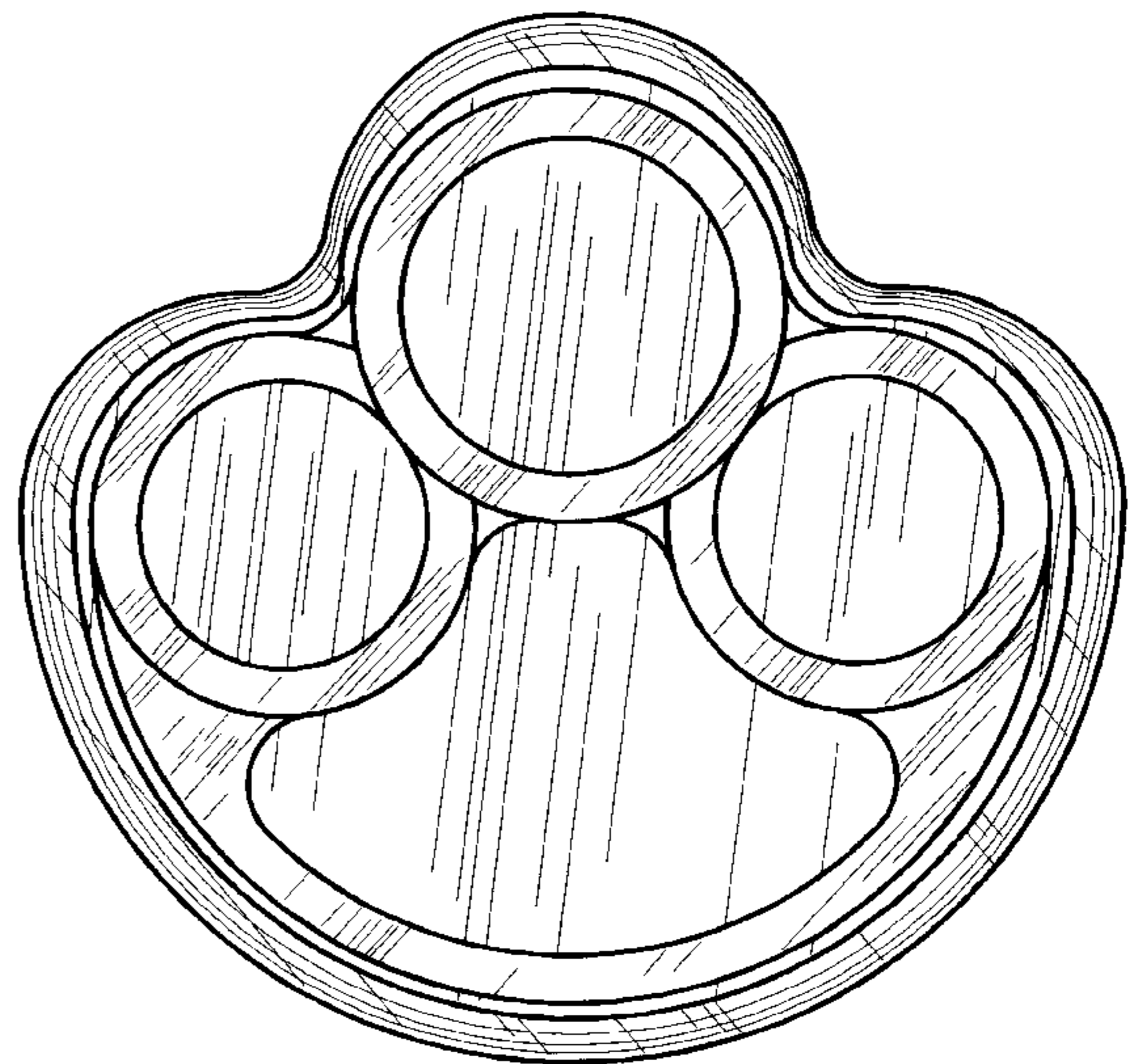
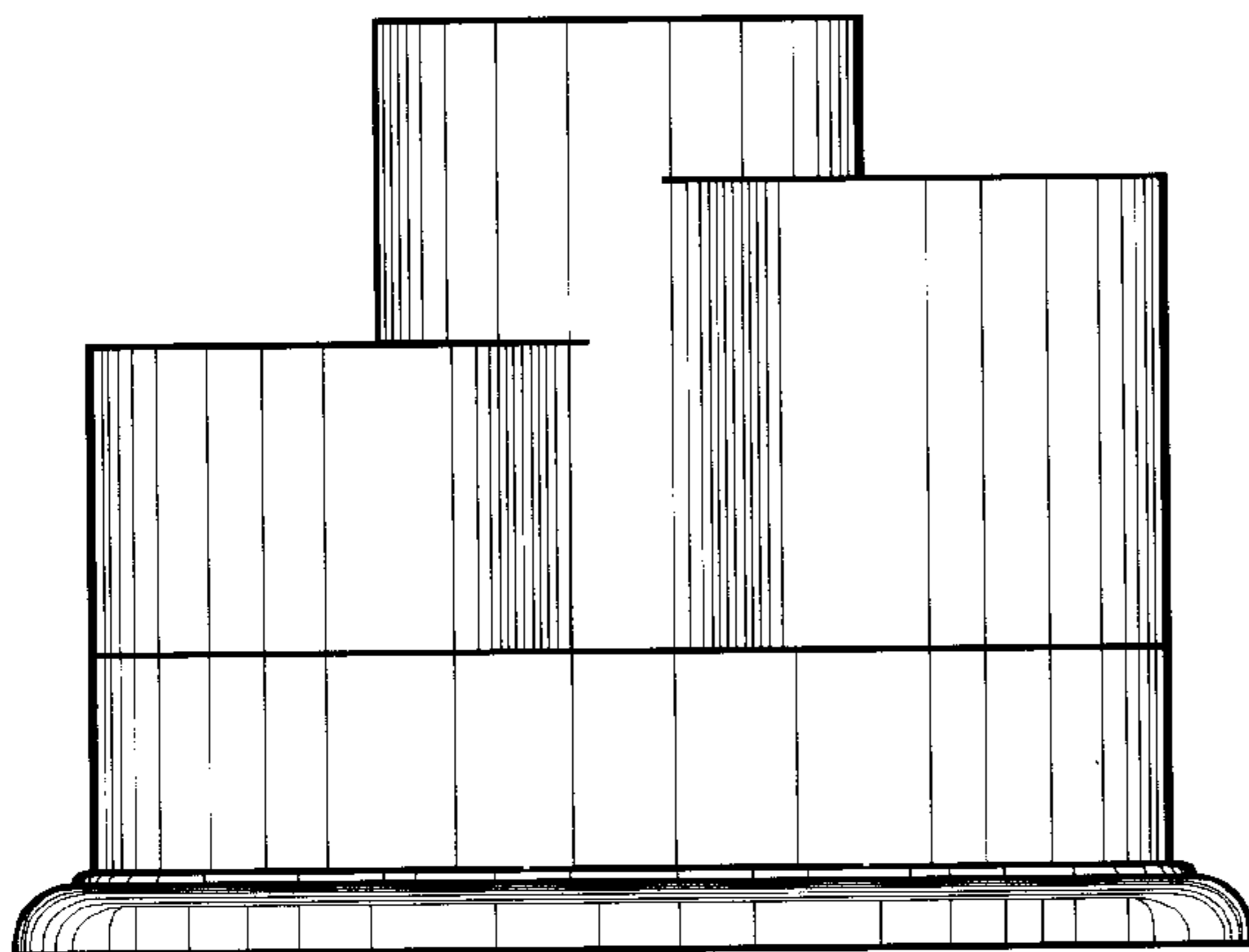

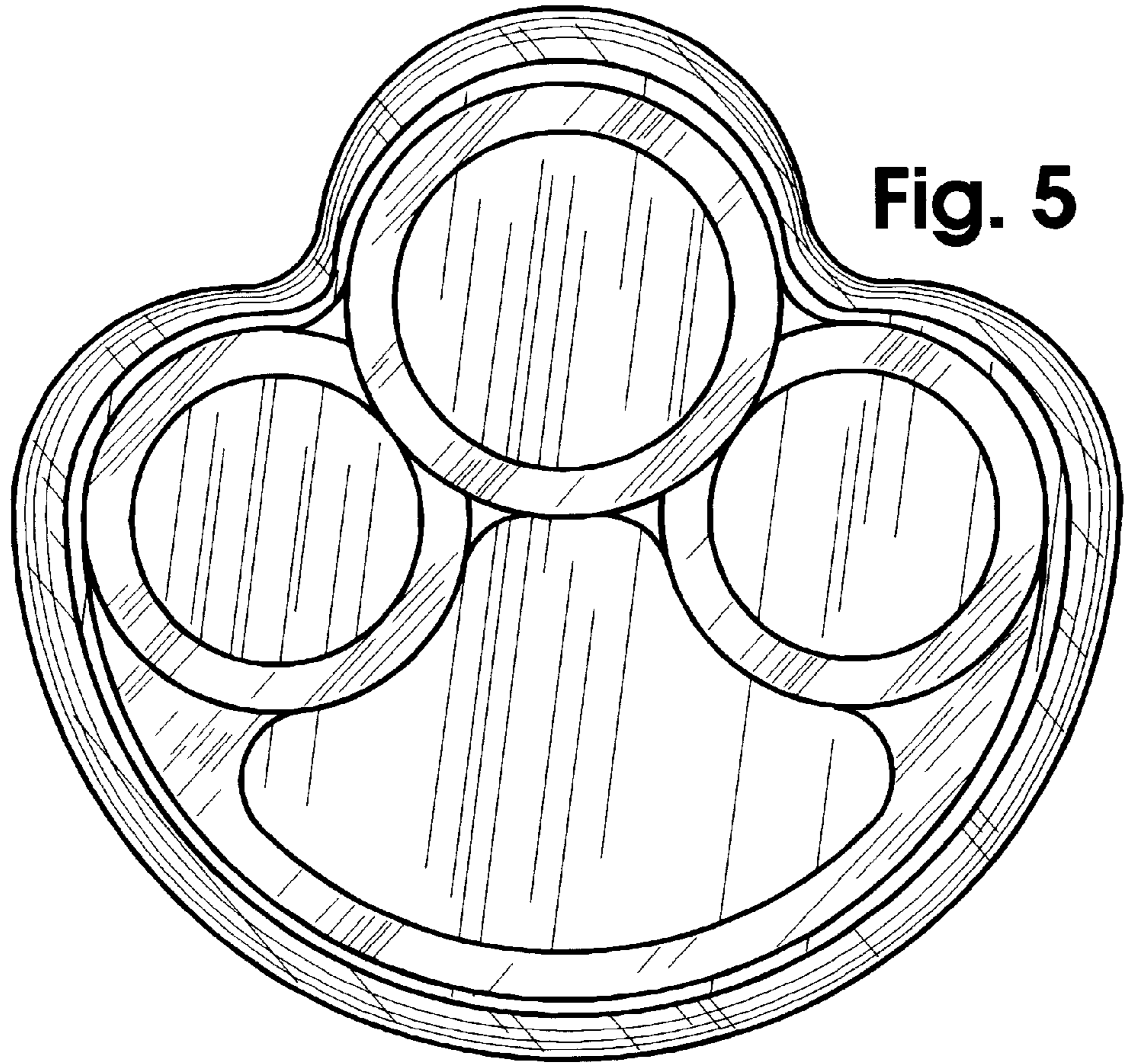
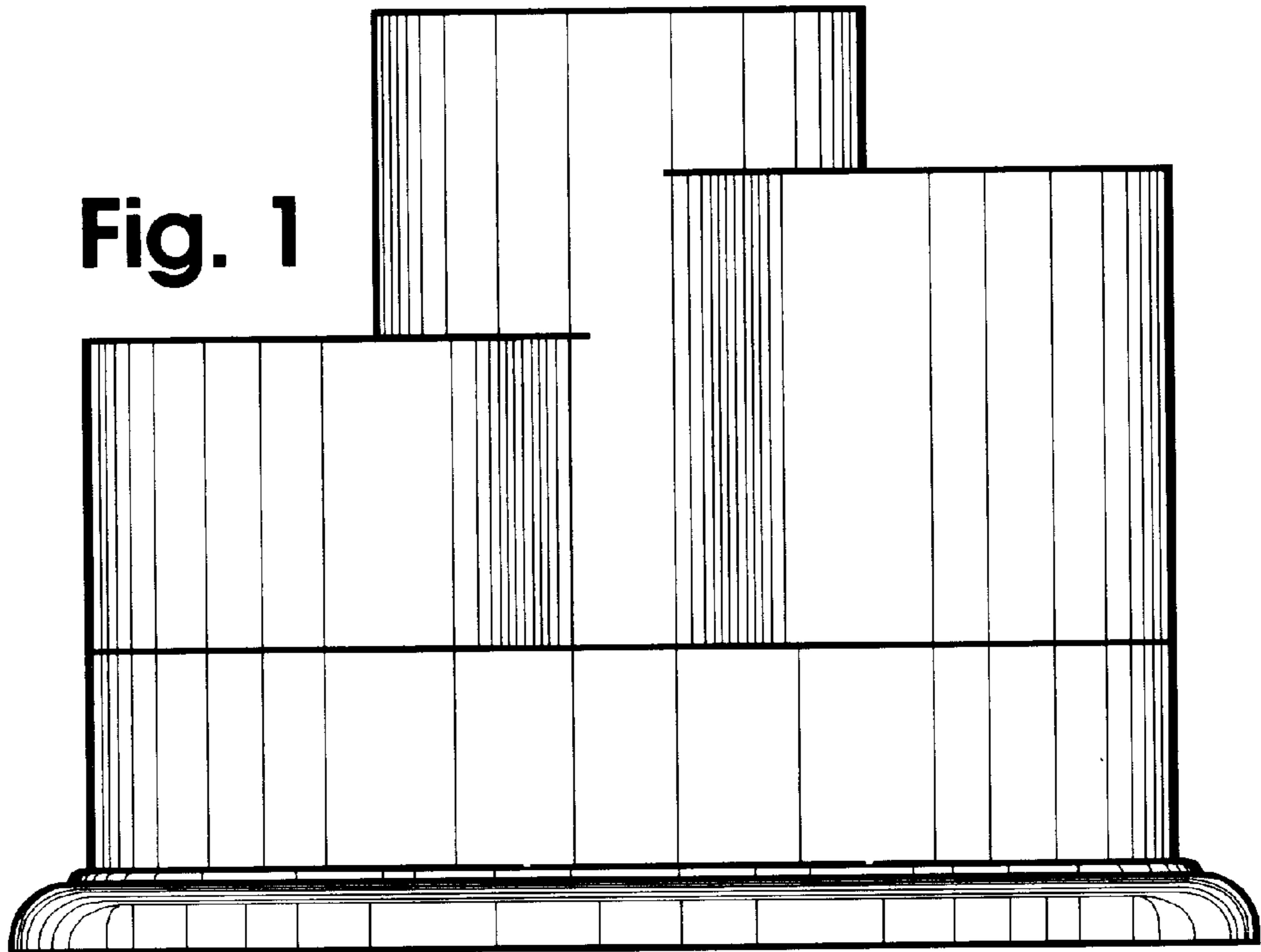

Fig. 1



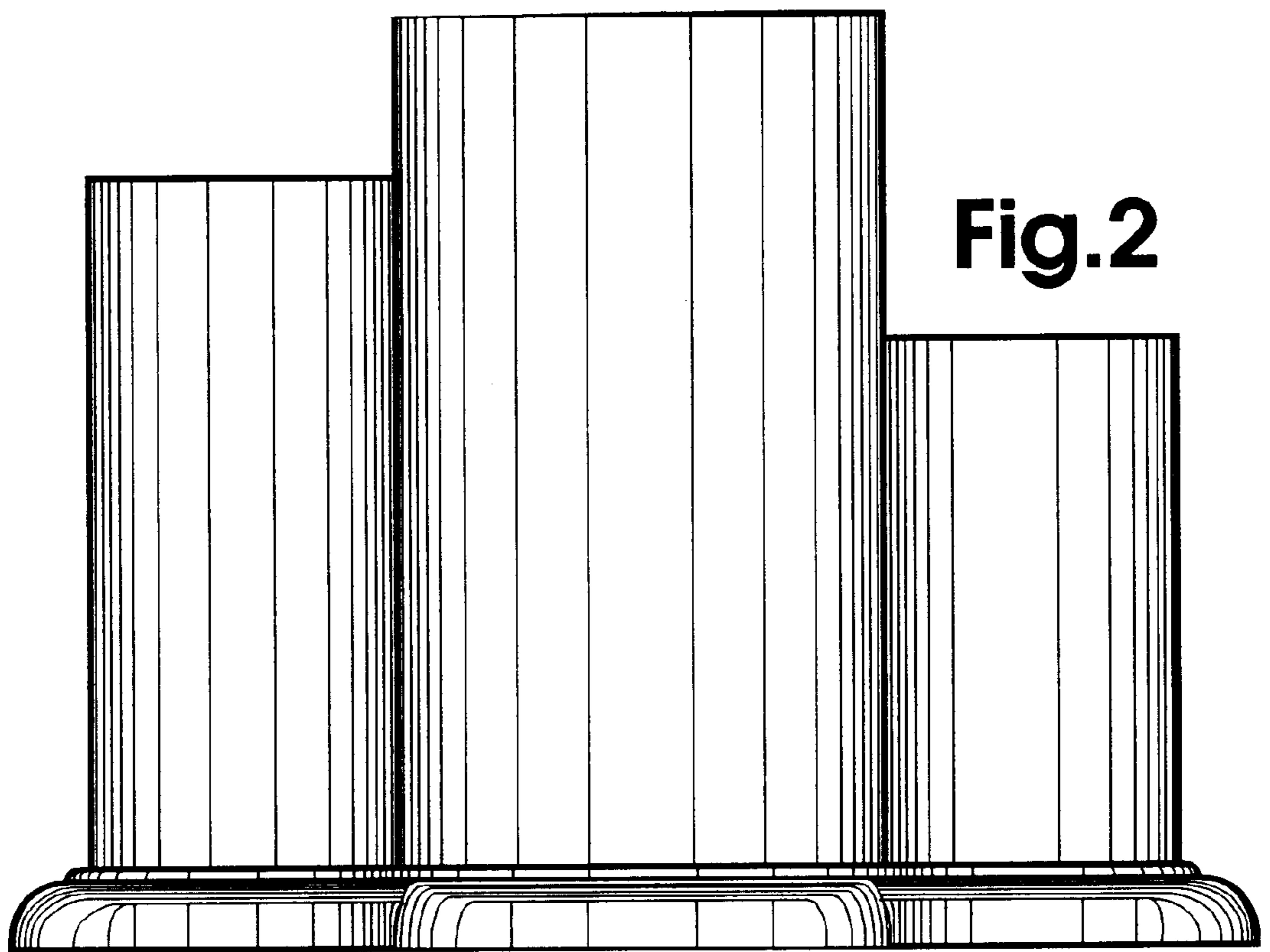
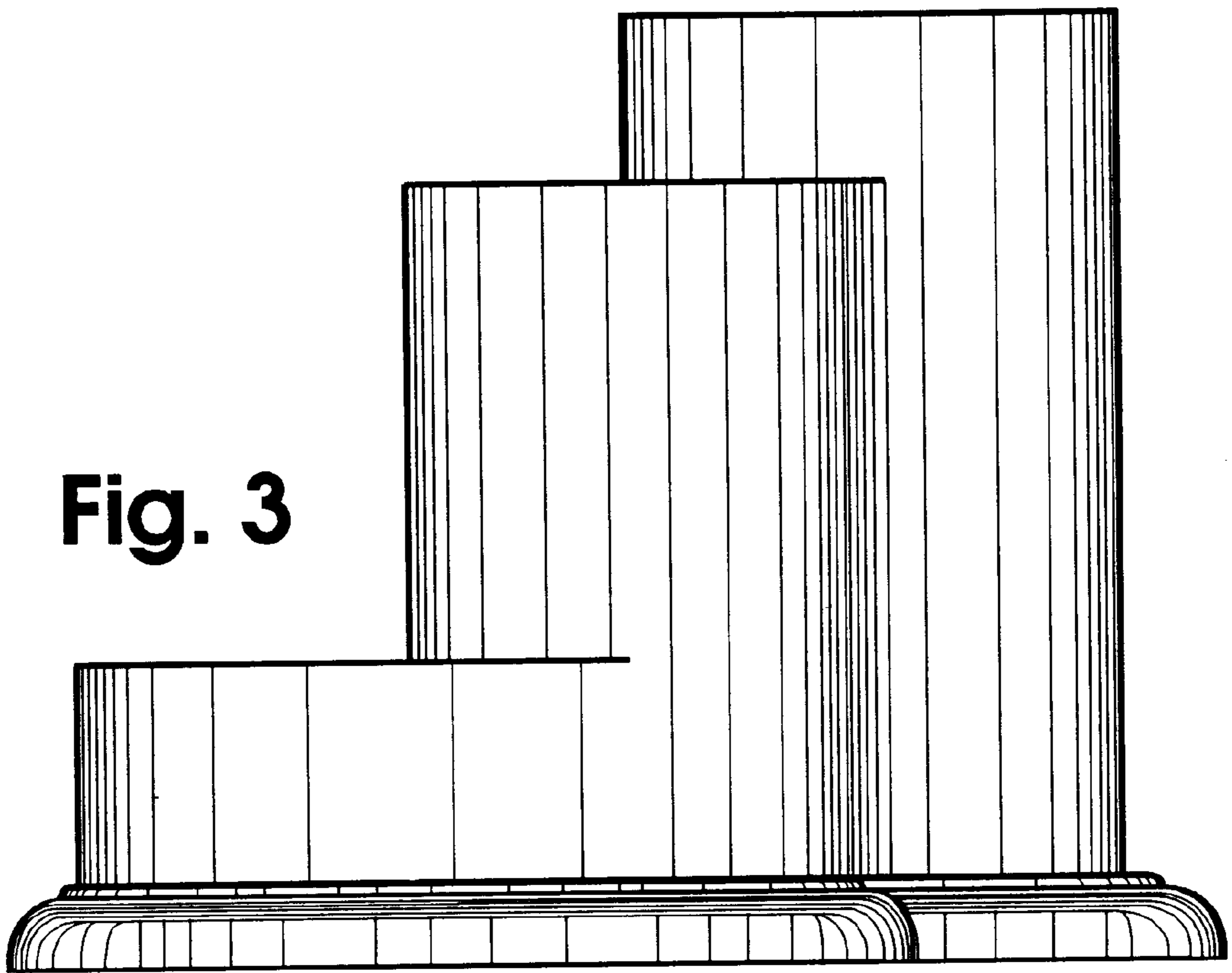

Fig.2

Fig. 3



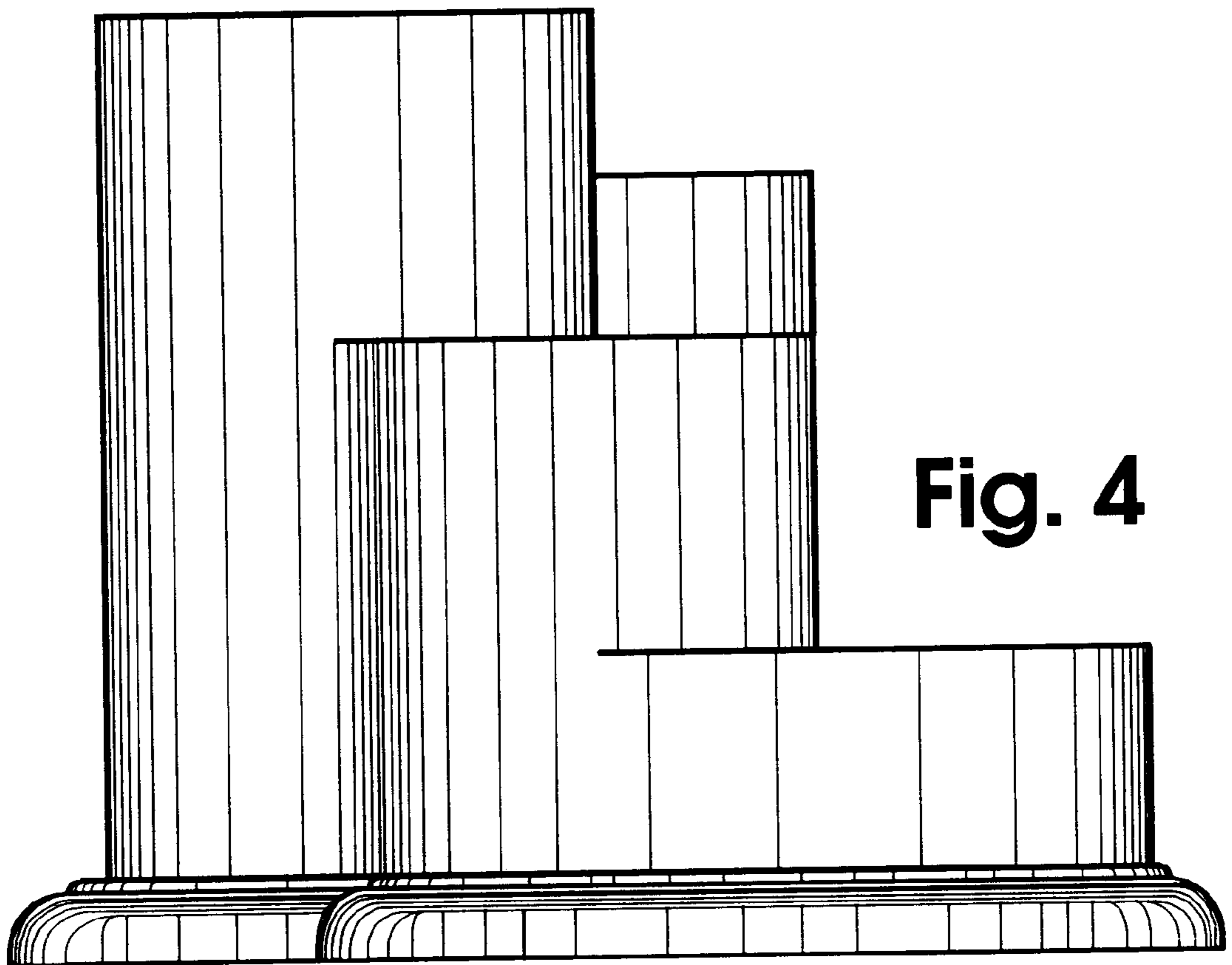

Fig. 4