



US00D421453S

United States Patent [19]

Thraikill et al.

[11] Patent Number: **Des. 421,453**

[45] Date of Patent: **** Mar. 7, 2000**

[54] **MAILING SYSTEM**

[75] Inventors: **Patrick T. Thraikill**, New Haven;
Joseph B. Sugrue; **David W. Beckstrom**, both of Fairfield, all of Conn.

[73] Assignee: **Pitney Bowes Inc.**, Stamford, Conn.

[**] Term: **14 Years**

[21] Appl. No.: **29/107,336**

[22] Filed: **Jul. 1, 1999**

[51] **LOC (6) Cl.** **18-02**

[52] **U.S. Cl.** **D18/51**; D18/50

[58] **Field of Search** D18/99, 50-52,
D18/54-55; D19/60; D14/105, 106; 101/76,
77, 91, 47, 95, 99, 85; 235/375; 400/692;
364/227.3, 227.4, 918.52; 347/222; 709/900

[56] **References Cited**

U.S. PATENT DOCUMENTS

- D. 257,153 9/1980 Woods et al. D18/51
- D. 326,677 6/1992 Nobile et al. D18/51
- D. 330,386 10/1992 Doeberl et al. D18/51

- D. 361,780 8/1995 Jenkins D18/51
- D. 377,502 1/1997 Mimoto D18/54
- D. 380,770 7/1997 Muchenberger et al. D18/51
- D. 400,191 10/1998 Butts et al. D14/105
- D. 402,689 12/1998 Brown et al. D18/55
- D. 404,422 1/1999 Beckstrom et al. D18/51

Primary Examiner—Louis S. Zarfaz

Assistant Examiner—G Andoll

Attorney, Agent, or Firm—Angelo N. Chaclas; Michael E. Melton

[57] **CLAIM**

The ornamental design for a mailing system, as shown and described.

DESCRIPTION

FIG. 1, is a front, top and left side perspective view of a mailing system which incorporates the new design;
 FIG. 2, is a front, top and right side perspective view thereof;
 FIG. 3, is a front view thereof;
 FIG. 4, is a top view thereof;
 FIG. 5, is a right side view thereof;
 FIG. 6, is a left side view thereof;
 FIG. 7, is a rear view thereof; and,
 FIG. 8, is a bottom view thereof.

1 Claim, 8 Drawing Sheets

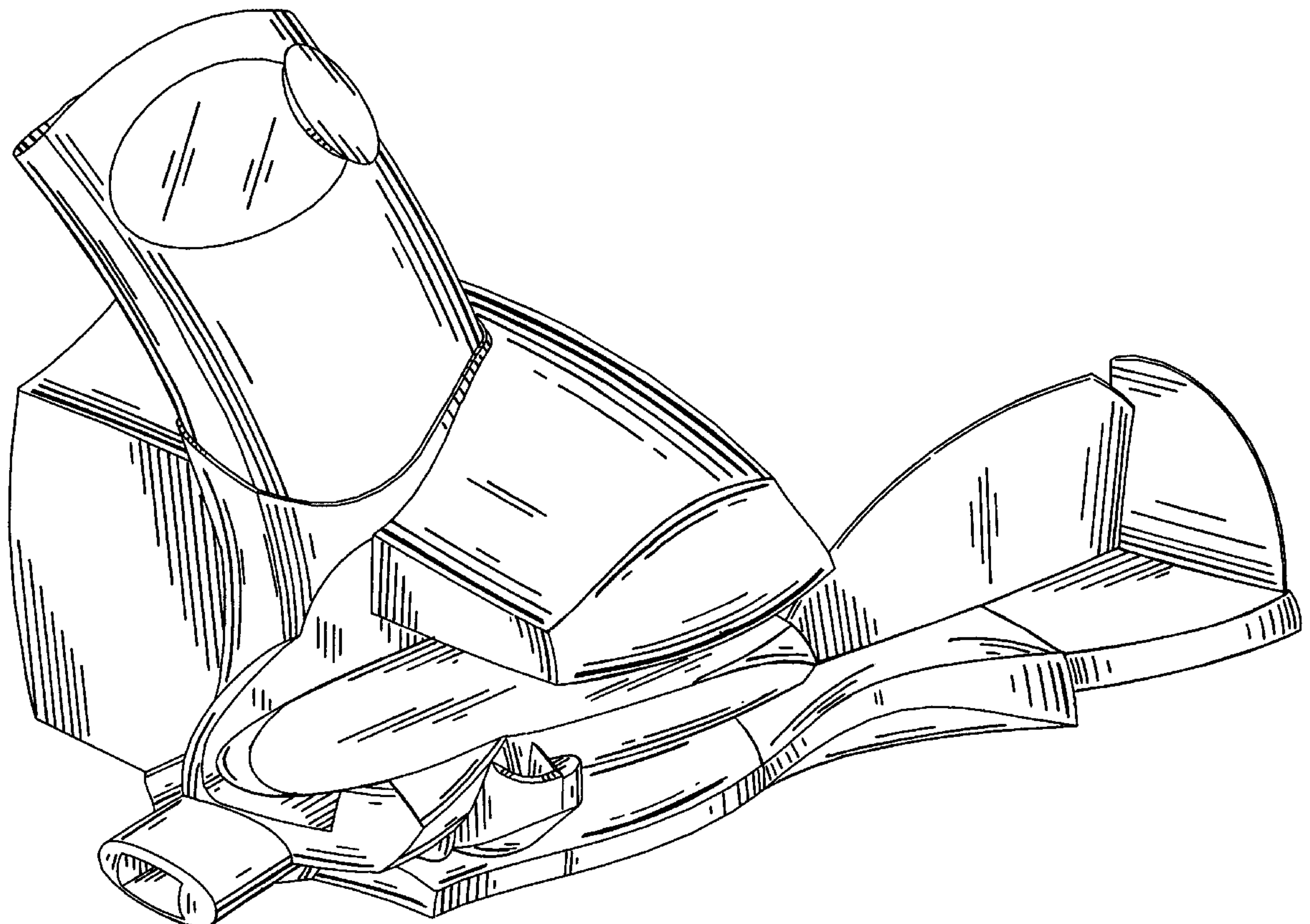

FIG. 1

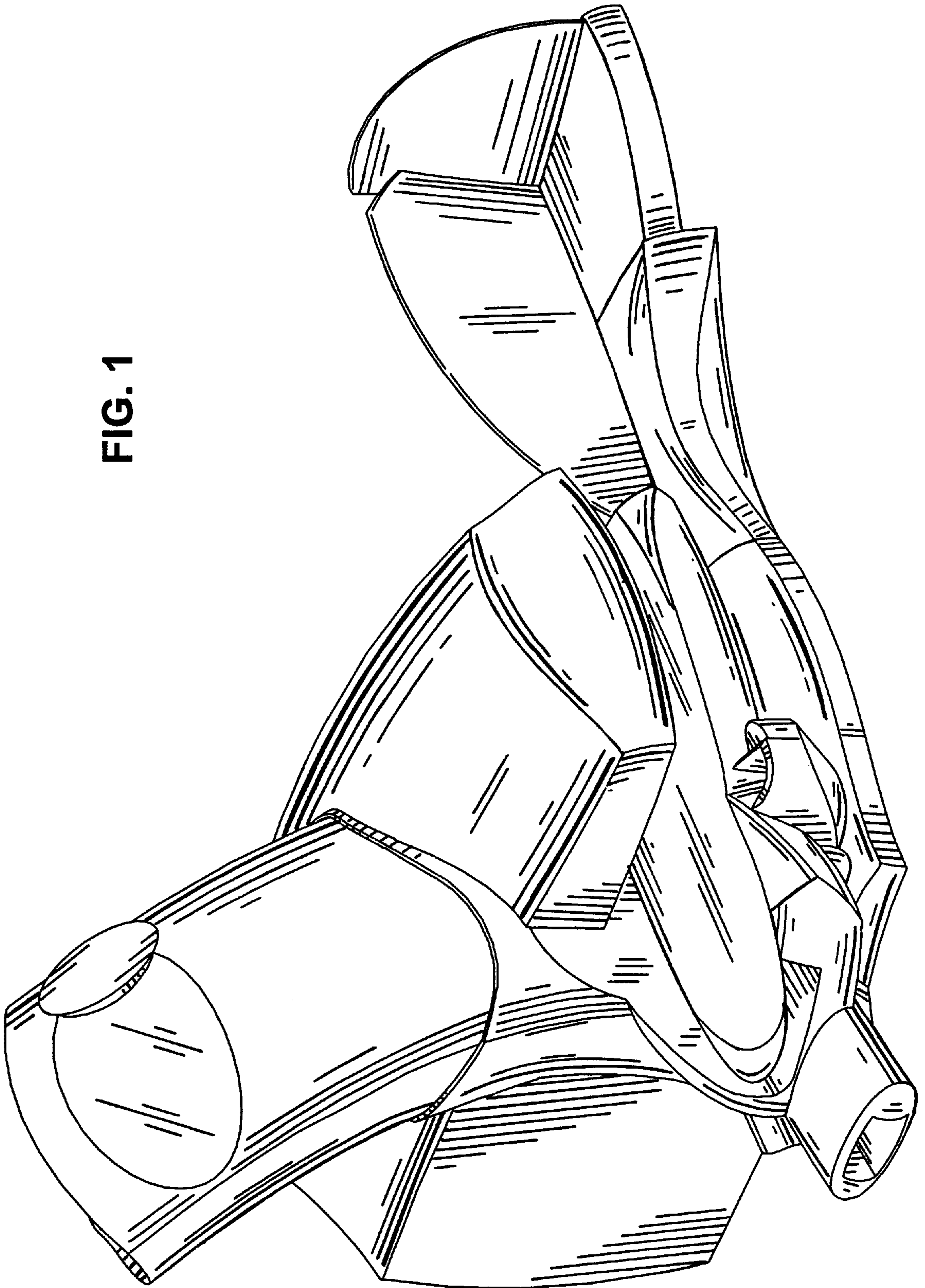

FIG. 2

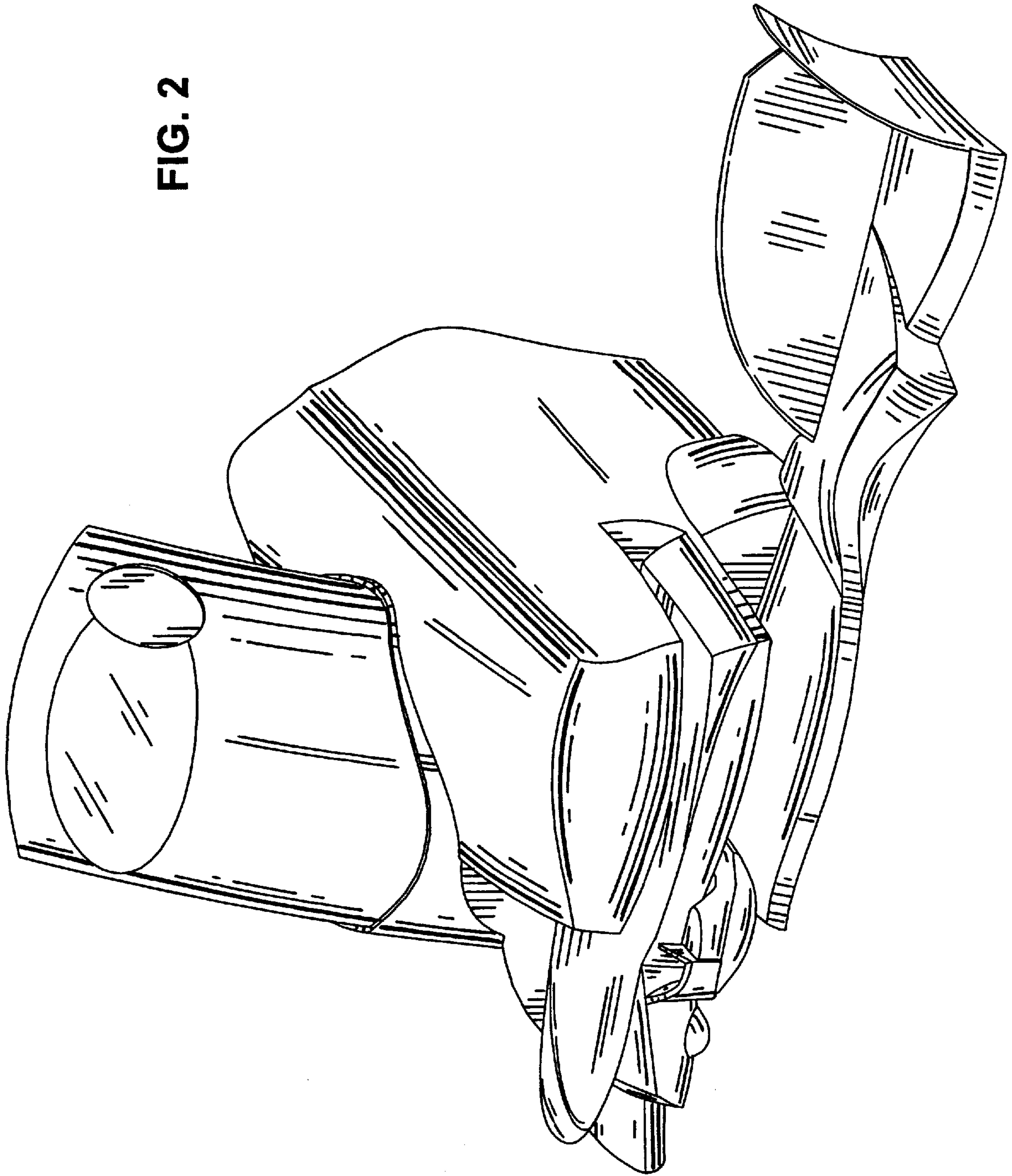

FIG. 3

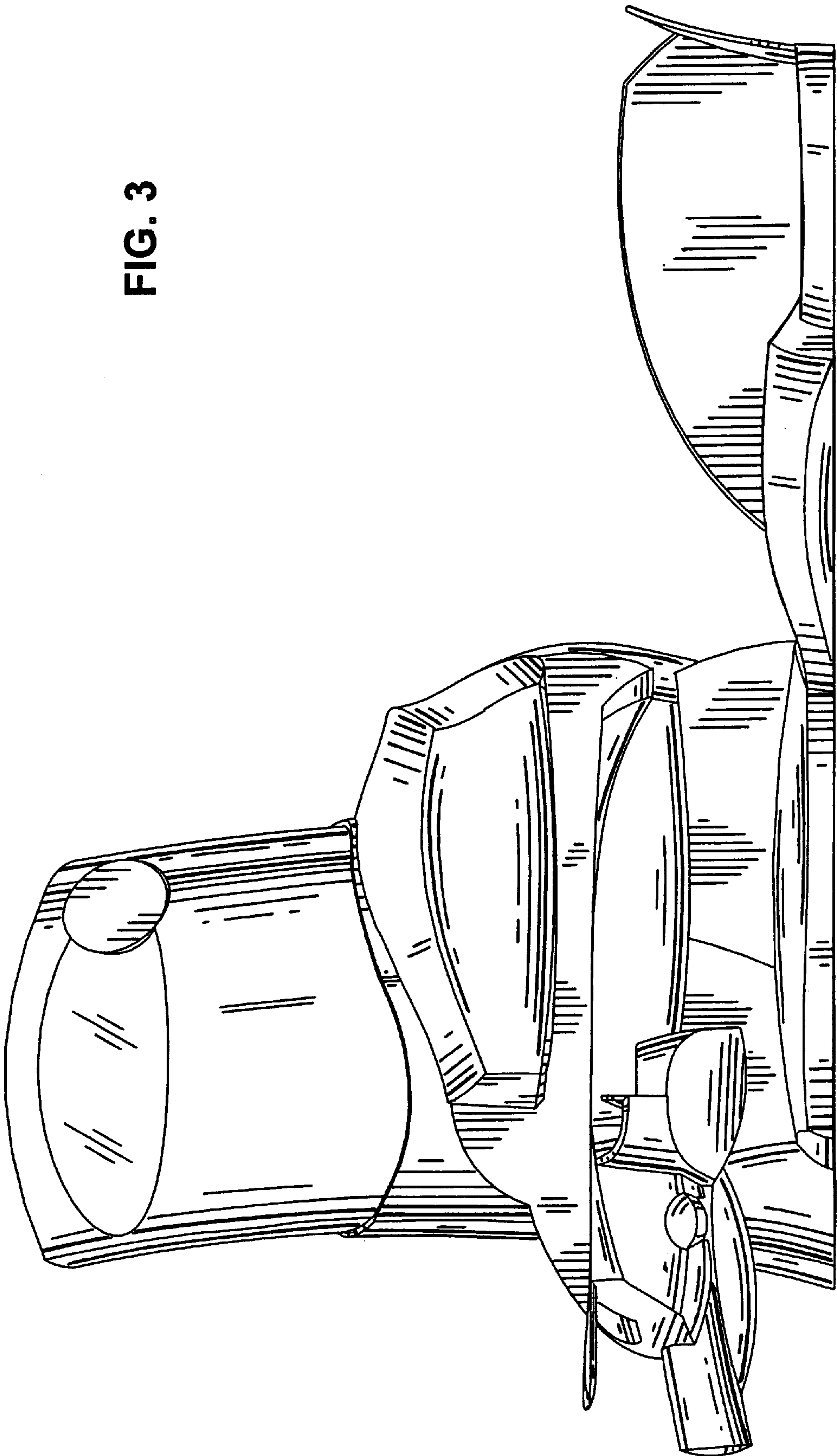
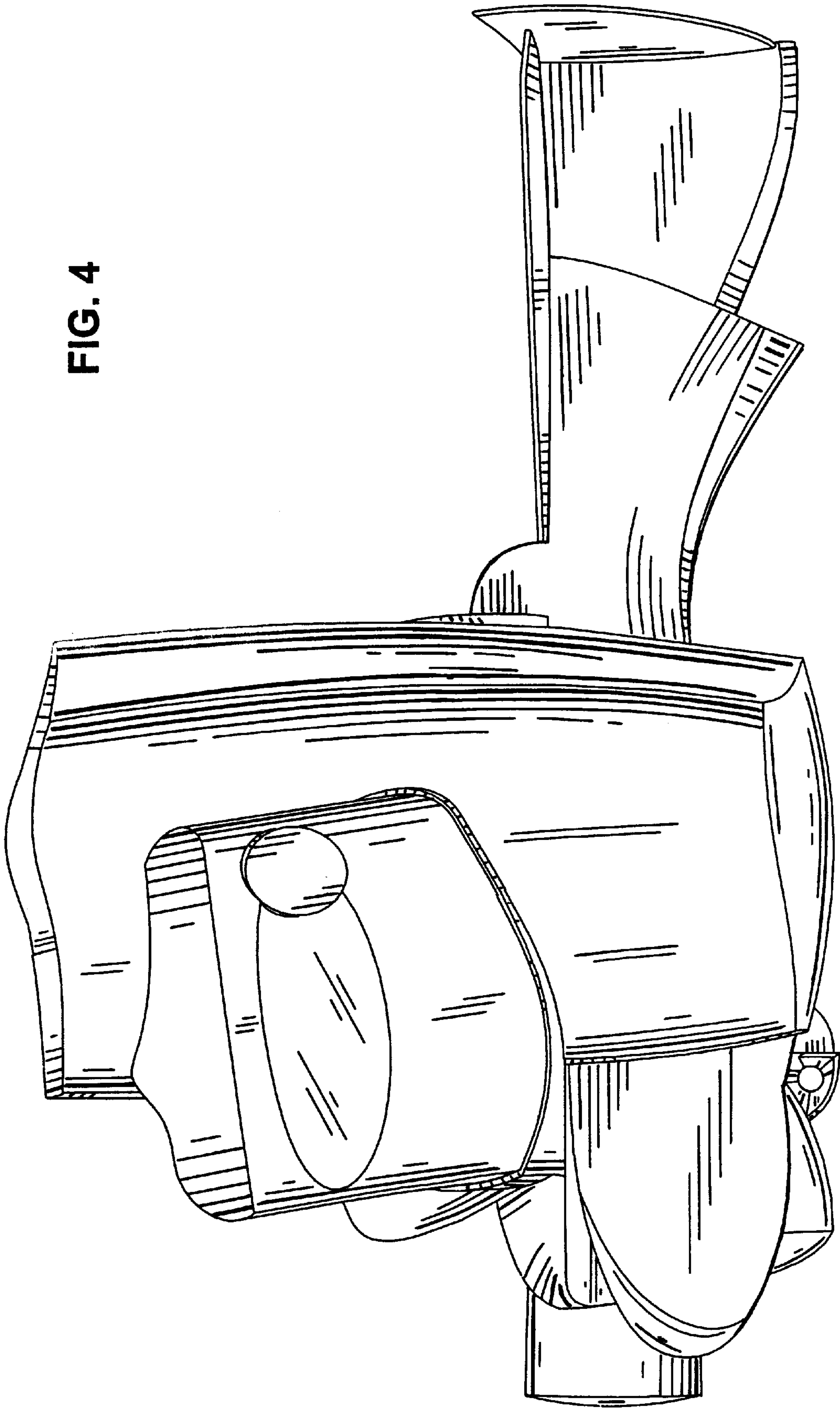

FIG. 4



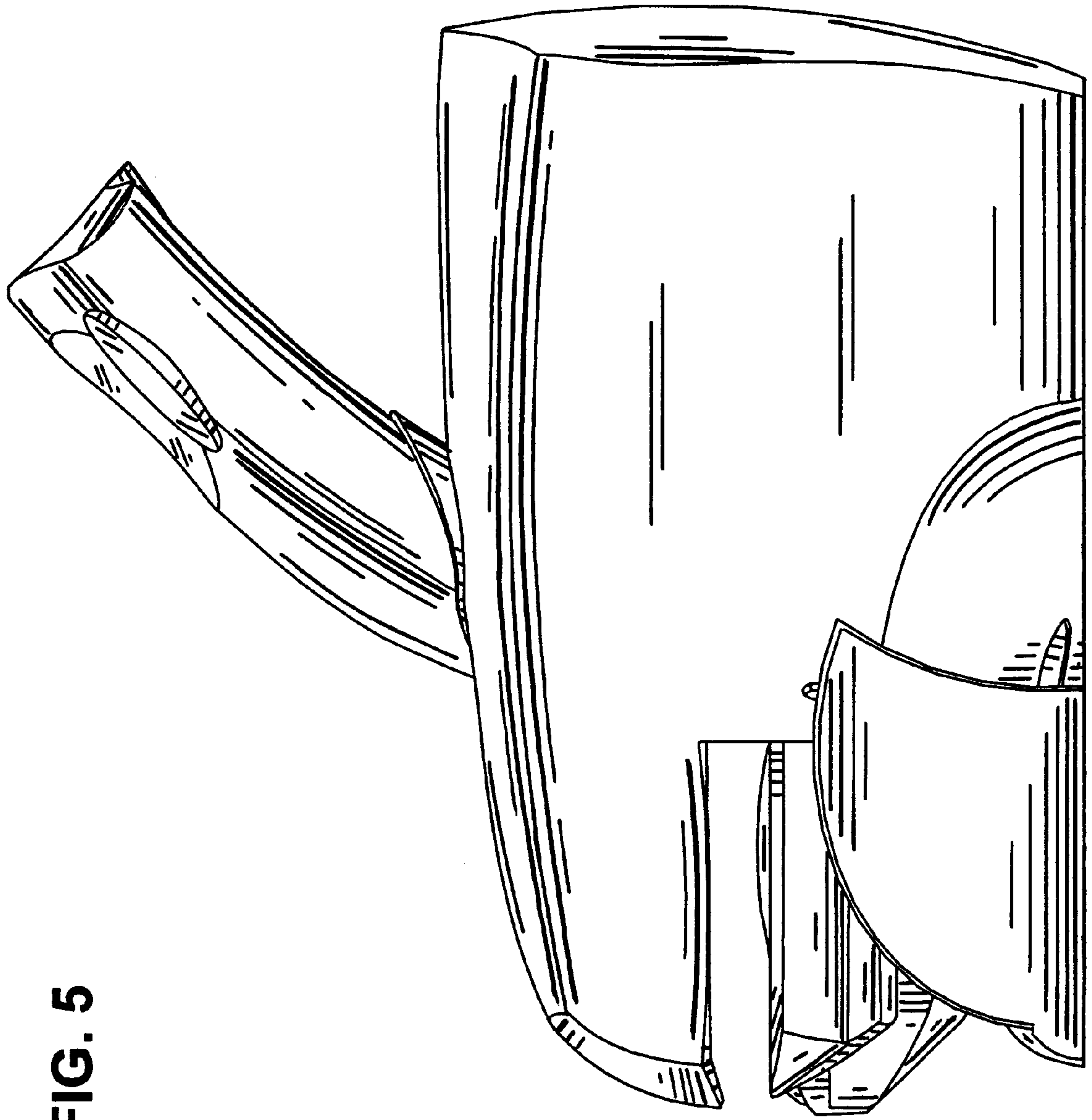
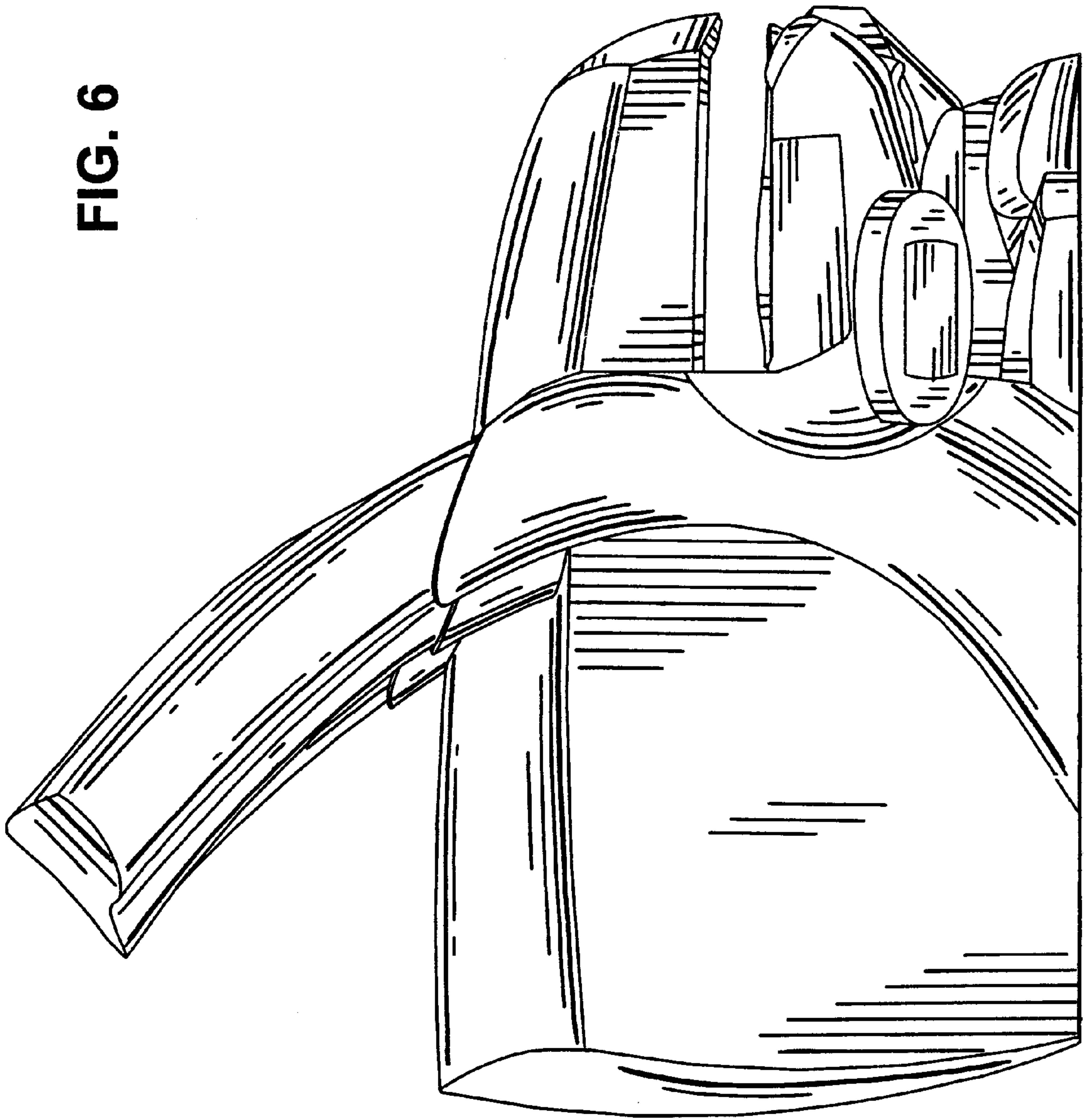

FIG. 5

FIG. 6



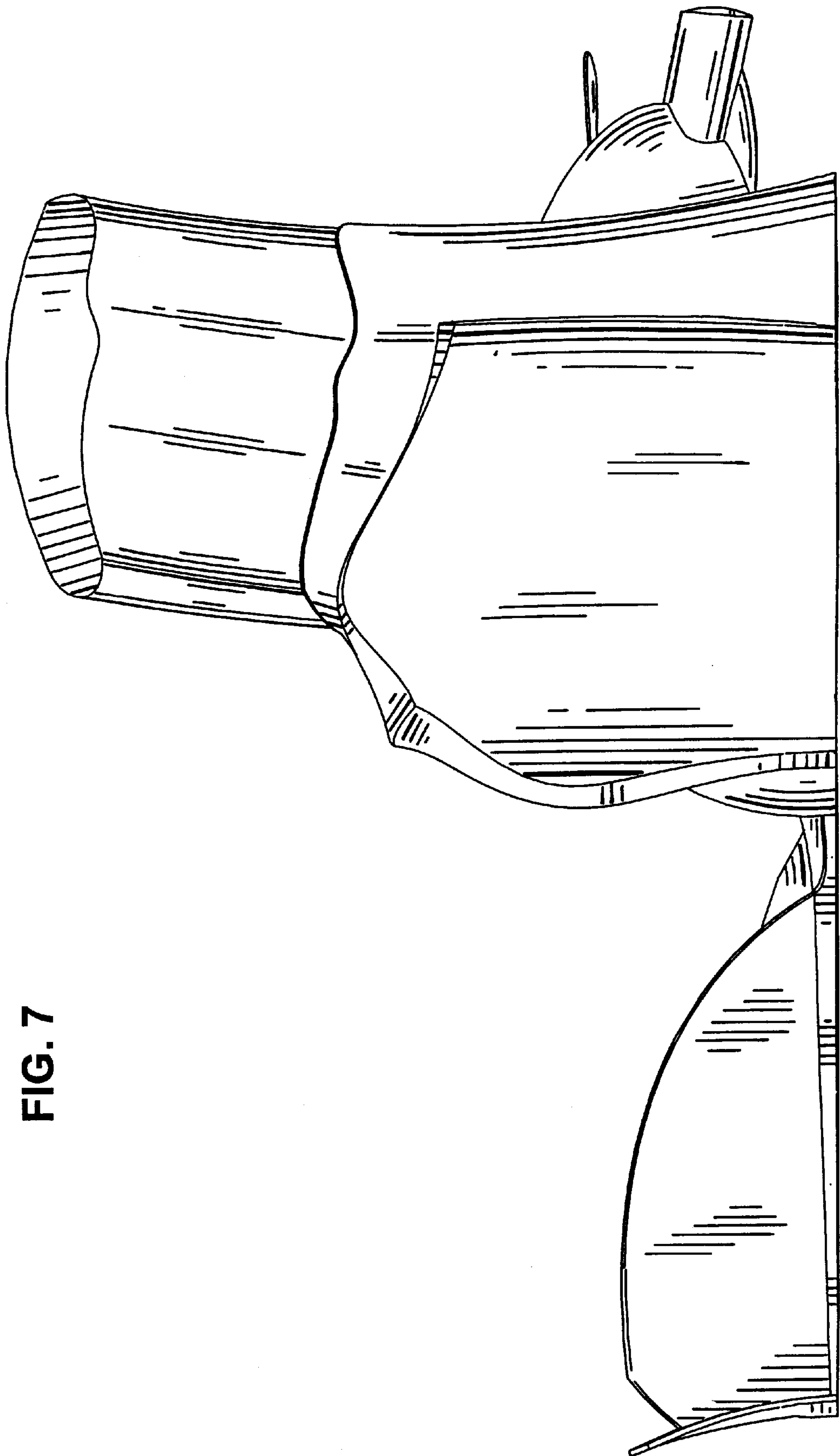

FIG. 7

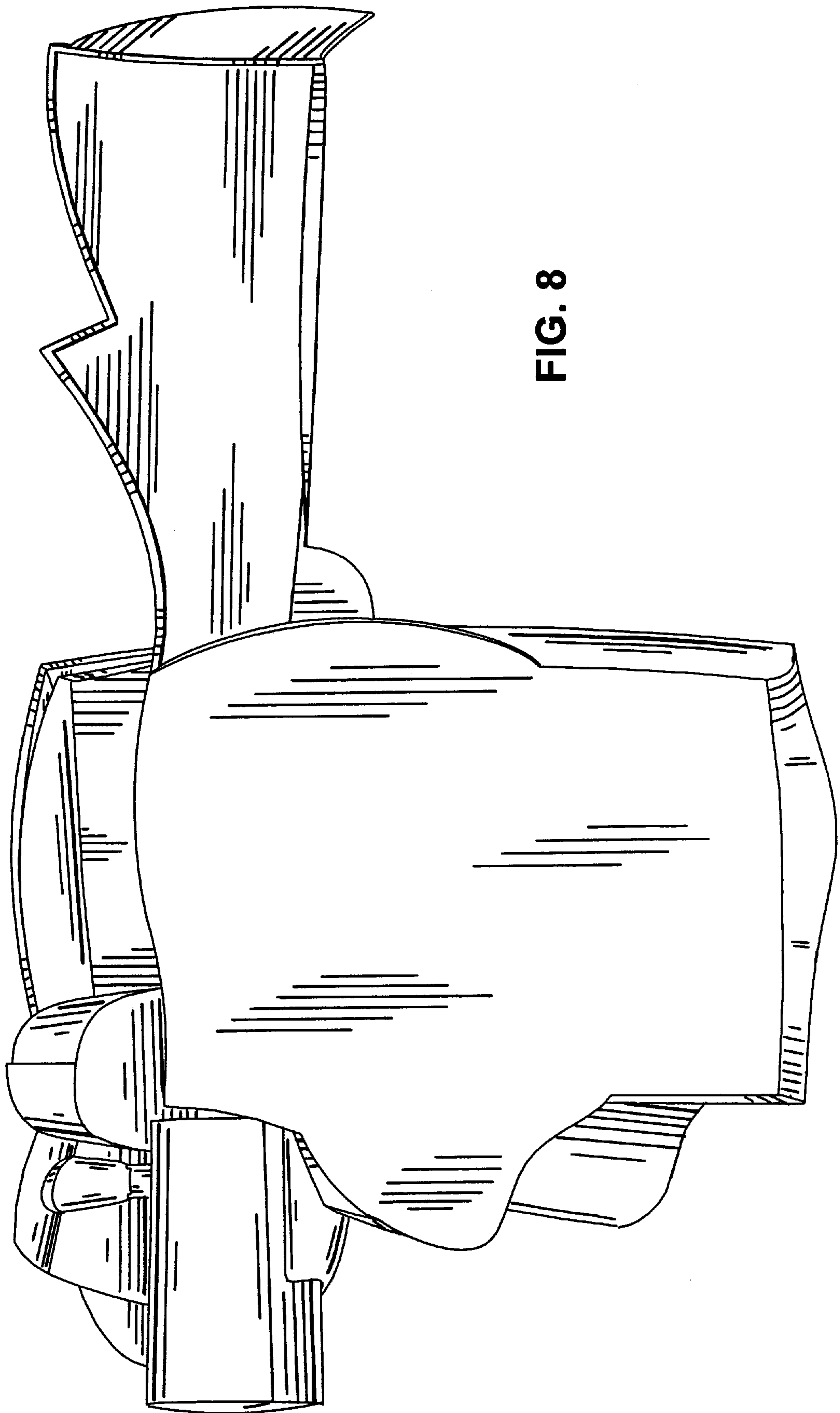

FIG. 8