



US00D421436S

United States Patent [19]
Matsuoka

[11] **Patent Number: Des. 421,436**
[45] **Date of Patent: ** Mar. 7, 2000**

- [54] **DIGITAL AUDIO DISC PLAYER**
- [75] Inventor: **Shoichiro Matsuoka**, Tokyo, Japan
- [73] Assignee: **Sony Corporation**, Tokyo, Japan
- [**] Term: **14 Years**
- [21] Appl. No.: **29/087,289**
- [22] Filed: **Apr. 30, 1998**
- [51] **LOC (6) Cl. 14-01**
- [52] **U.S. Cl. D14/156**
- [58] **Field of Search D14/124, 135,**
D14/136, 156, 157, 160-163, 167-168,
170-171, 188, 193-198; 369/75.1, 75.2,
77.1, 77.2; 455/344-347, 350, 351

[56] **References Cited**

U.S. PATENT DOCUMENTS

D. 284,963	8/1986	Imazeki	D14/198
D. 306,731	3/1990	Weisz et al.	D14/168
D. 315,733	3/1991	Shimasaki	D14/188 X
D. 372,715	8/1996	Lin	D14/156 X
D. 377,650	1/1997	Obata	D14/198 X

OTHER PUBLICATIONS

Sony Catalog "82" p. 114, (Mar. 1996).
Sony Catalog "87" p. 119, (Nov. 1997).

Primary Examiner—Nanda Bondade

Attorney, Agent, or Firm—Foley & Lardner

[57] **CLAIM**

The ornamental design for a digital audio disc player, as shown and described.

DESCRIPTION

FIG. 1 is a perspective view of a digital audio disc player showing my new design;

FIG. 2 is a top plan view of the first embodiment;

FIG. 3 is a left side elevational view thereof;

FIG. 4 is a front elevational view thereof;

FIG. 5 is a bottom plan view thereof;

FIG. 6 is a rear elevational view thereof;

FIG. 7 is a rear elevational view thereof; and,

FIG. 8 is a perspective view thereof, wherein the lid portion is in the open position. The broken line showing the insides of the digital audio disc player are for illustrative purposes only and form no part of the claimed design.

The inside portions of the digital audio disc player which are not visible in FIG. 8 form no part of the claimed design.

1 Claim, 6 Drawing Sheets

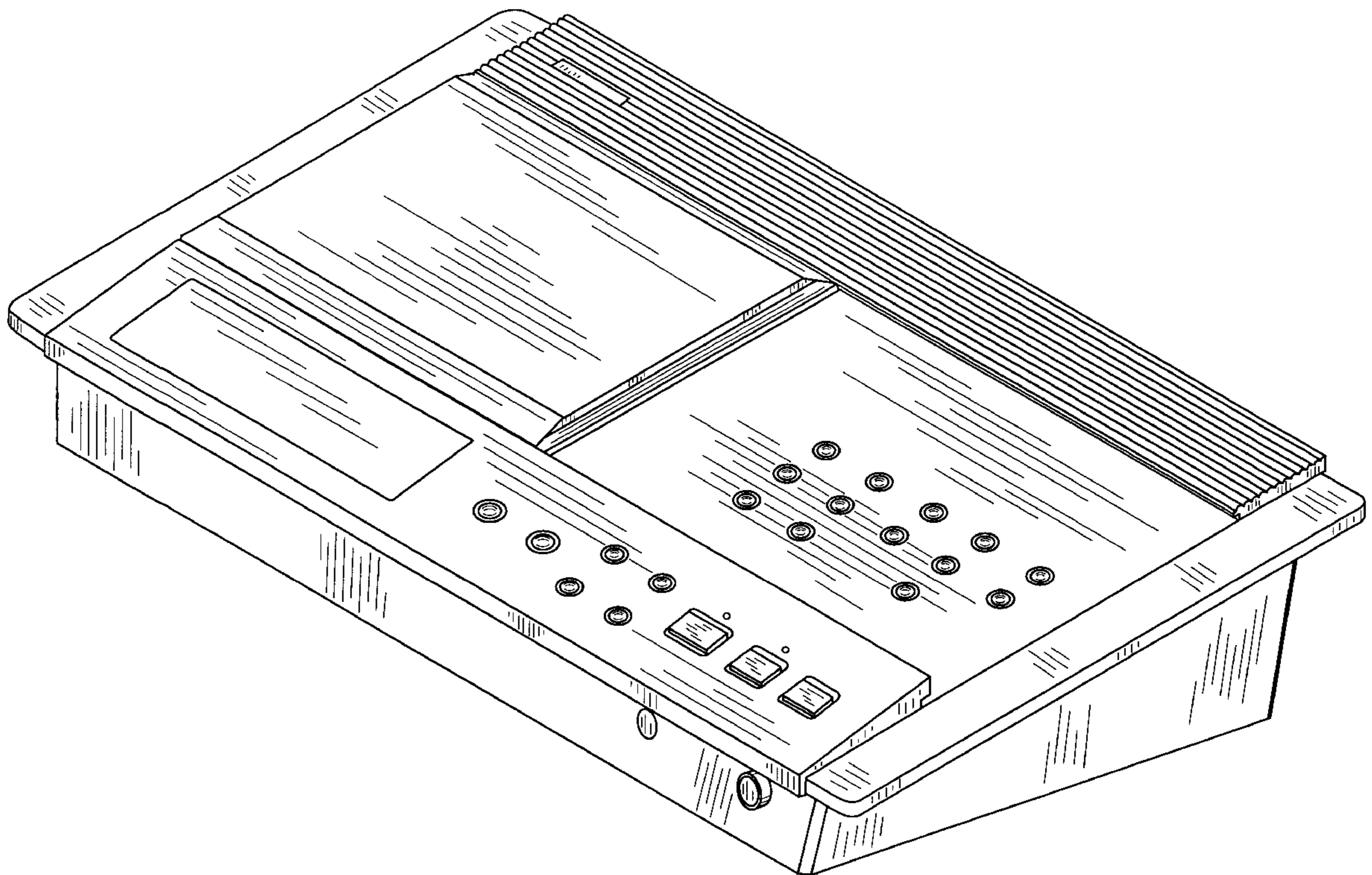

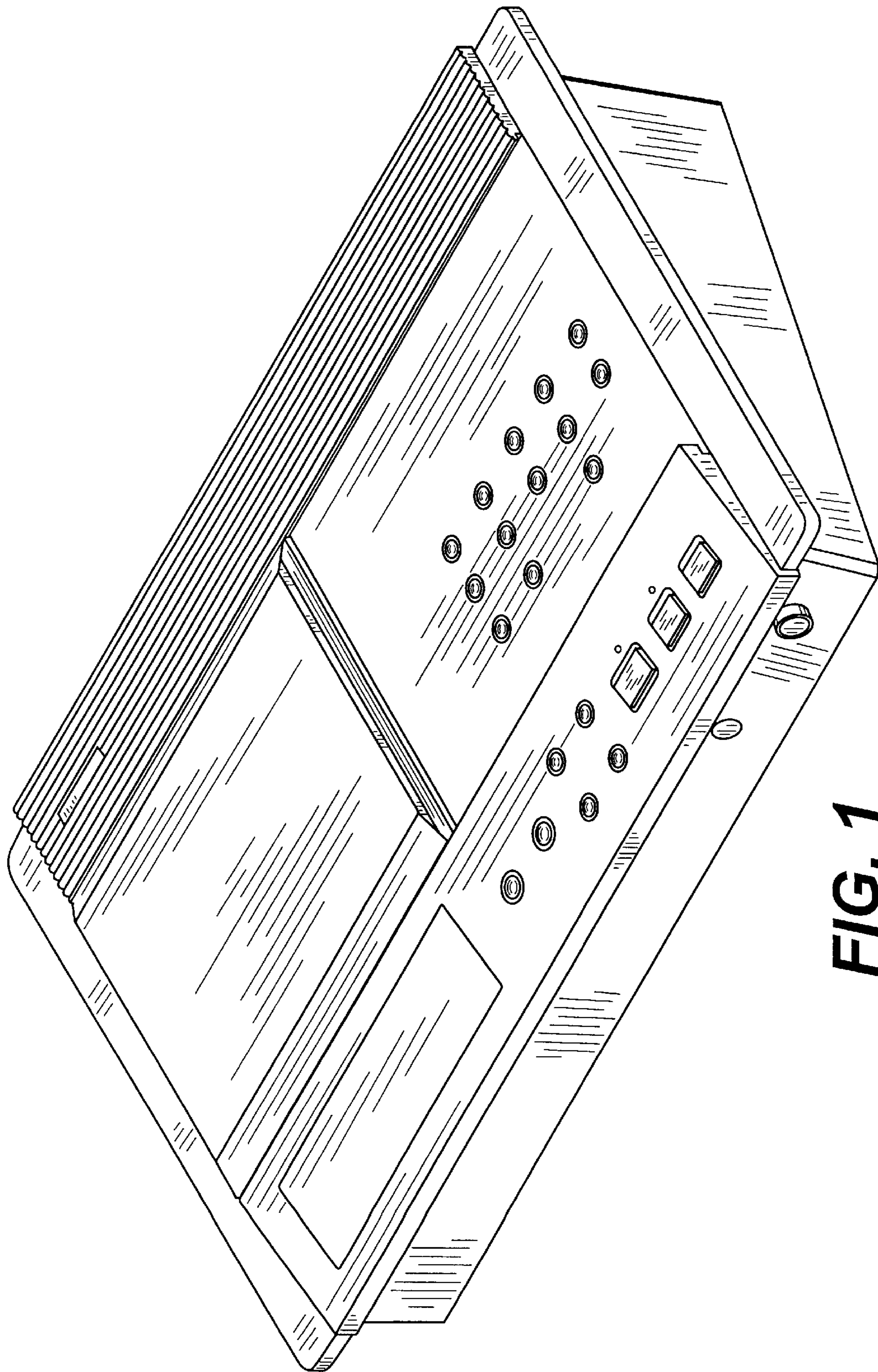

FIG. 1

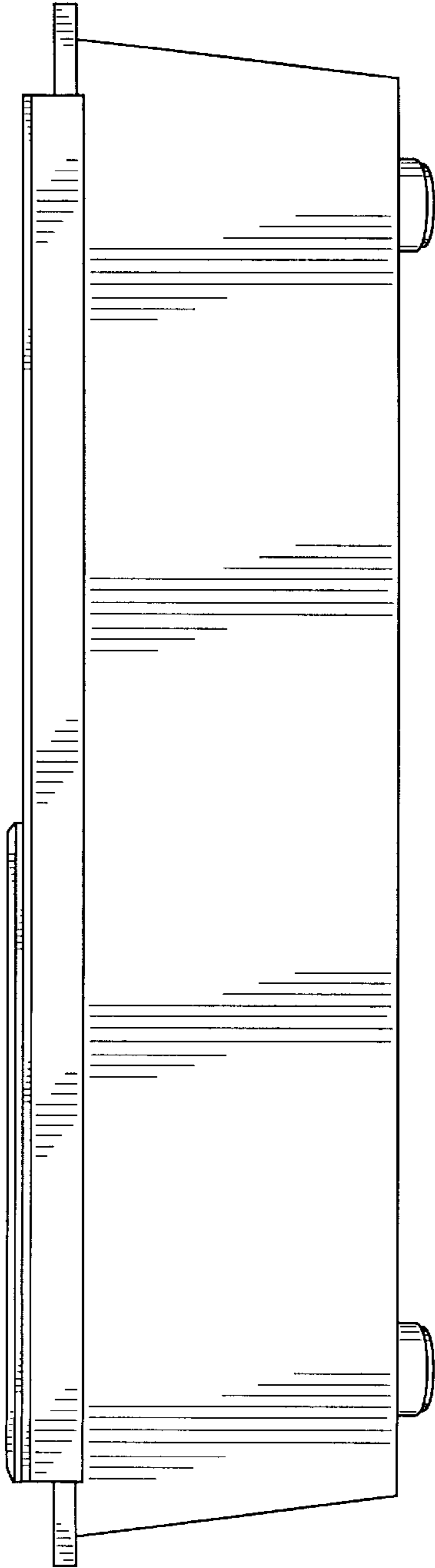

FIG. 2

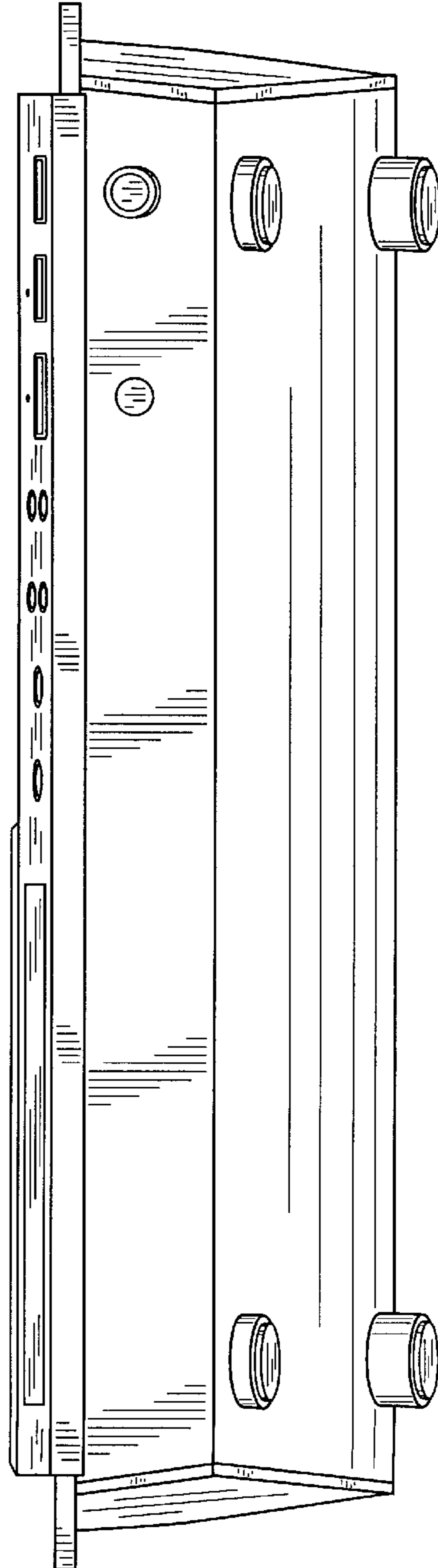

FIG. 5

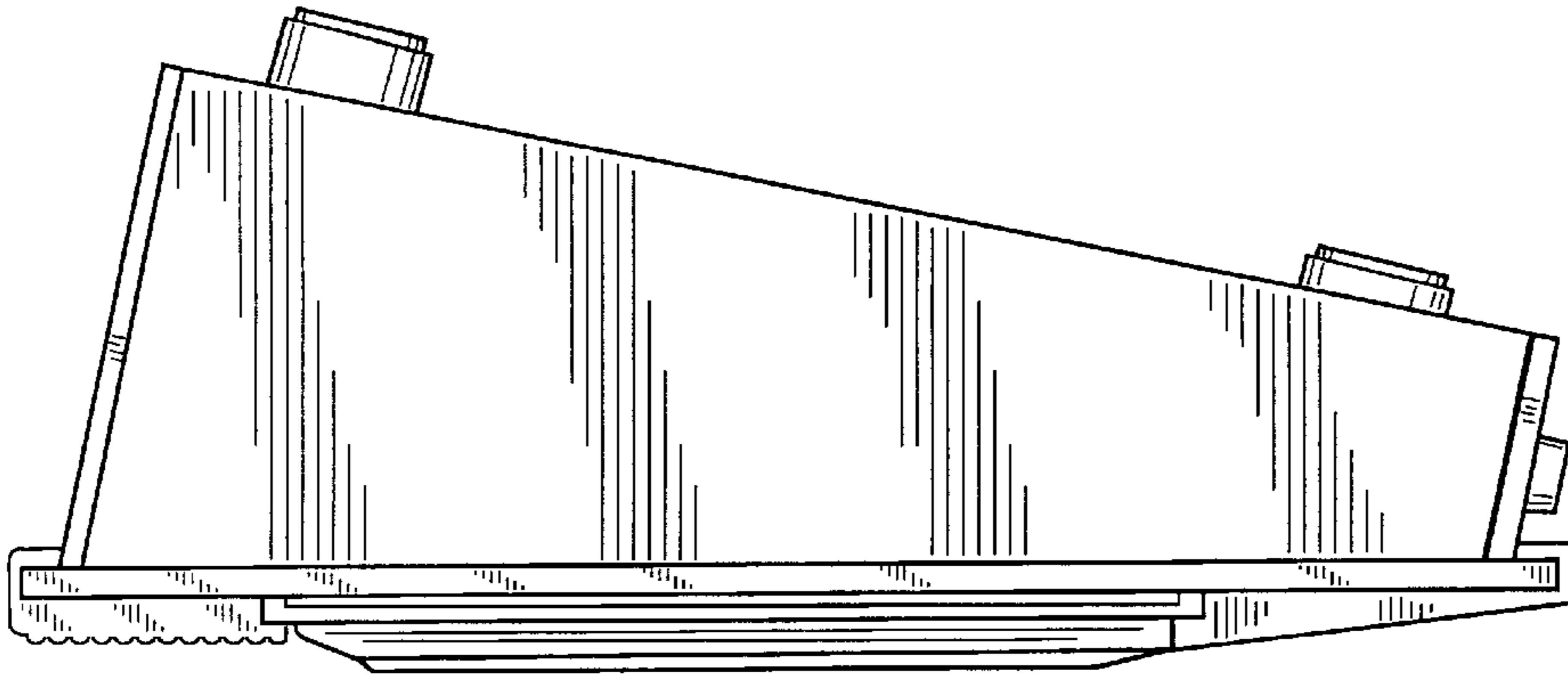

FIG. 6

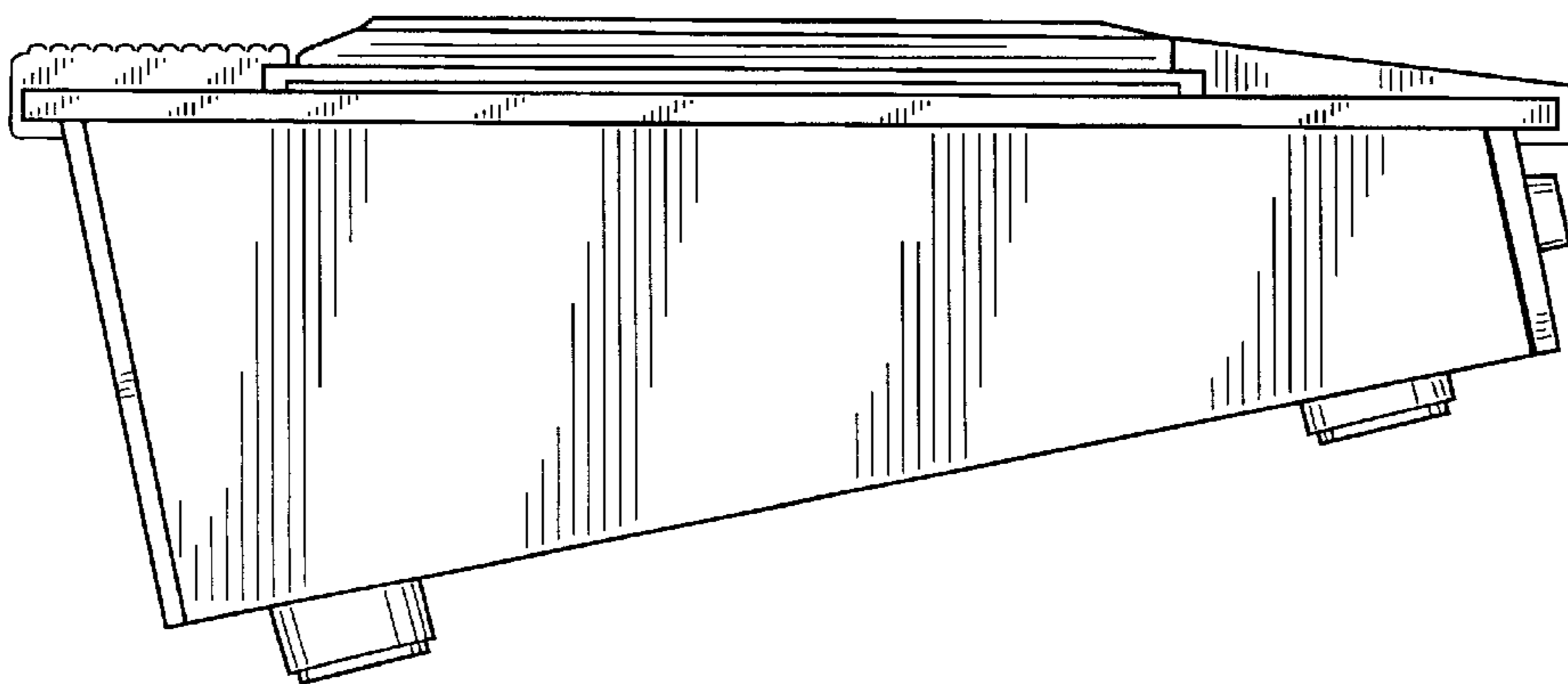

FIG. 3

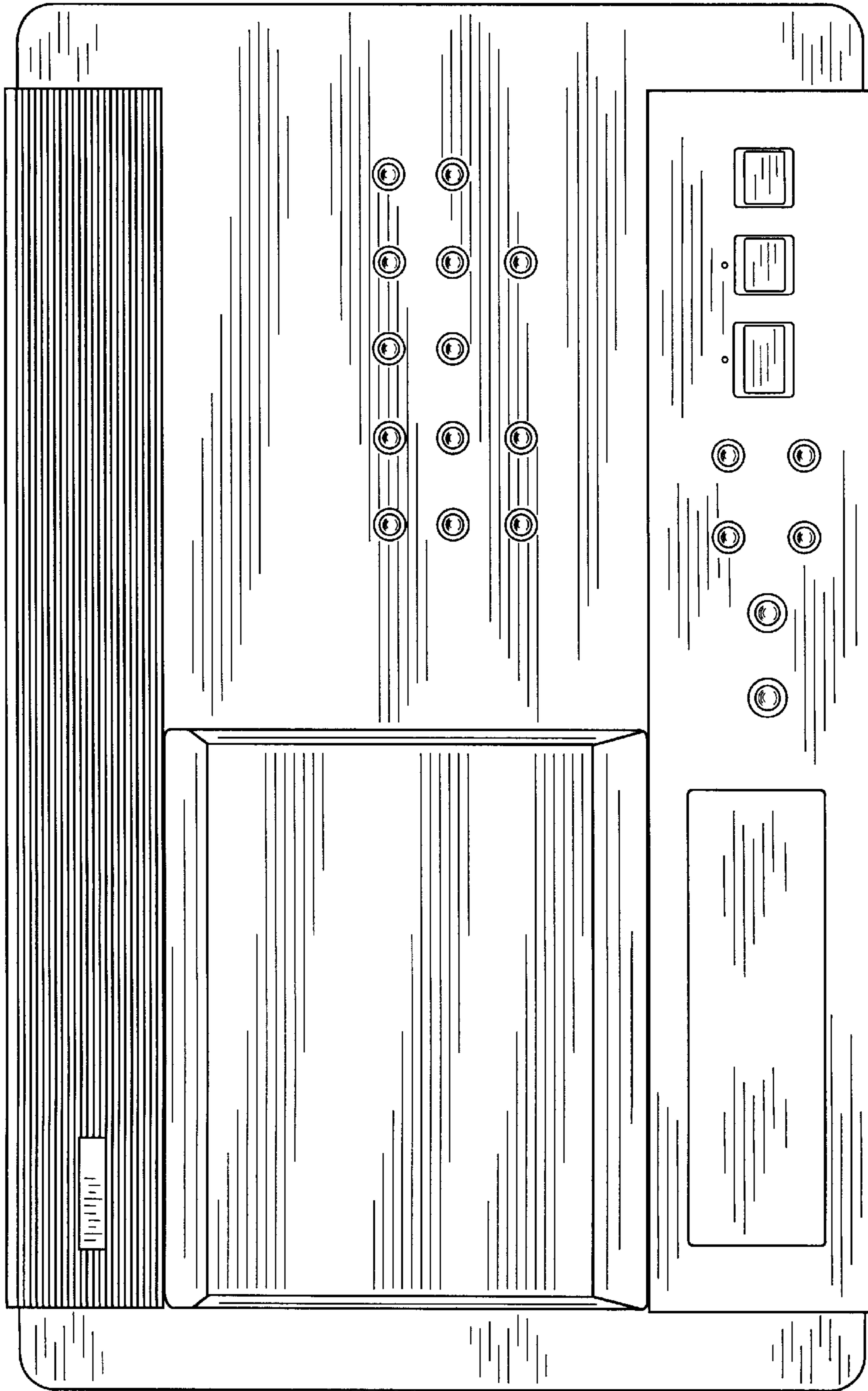

FIG. 4

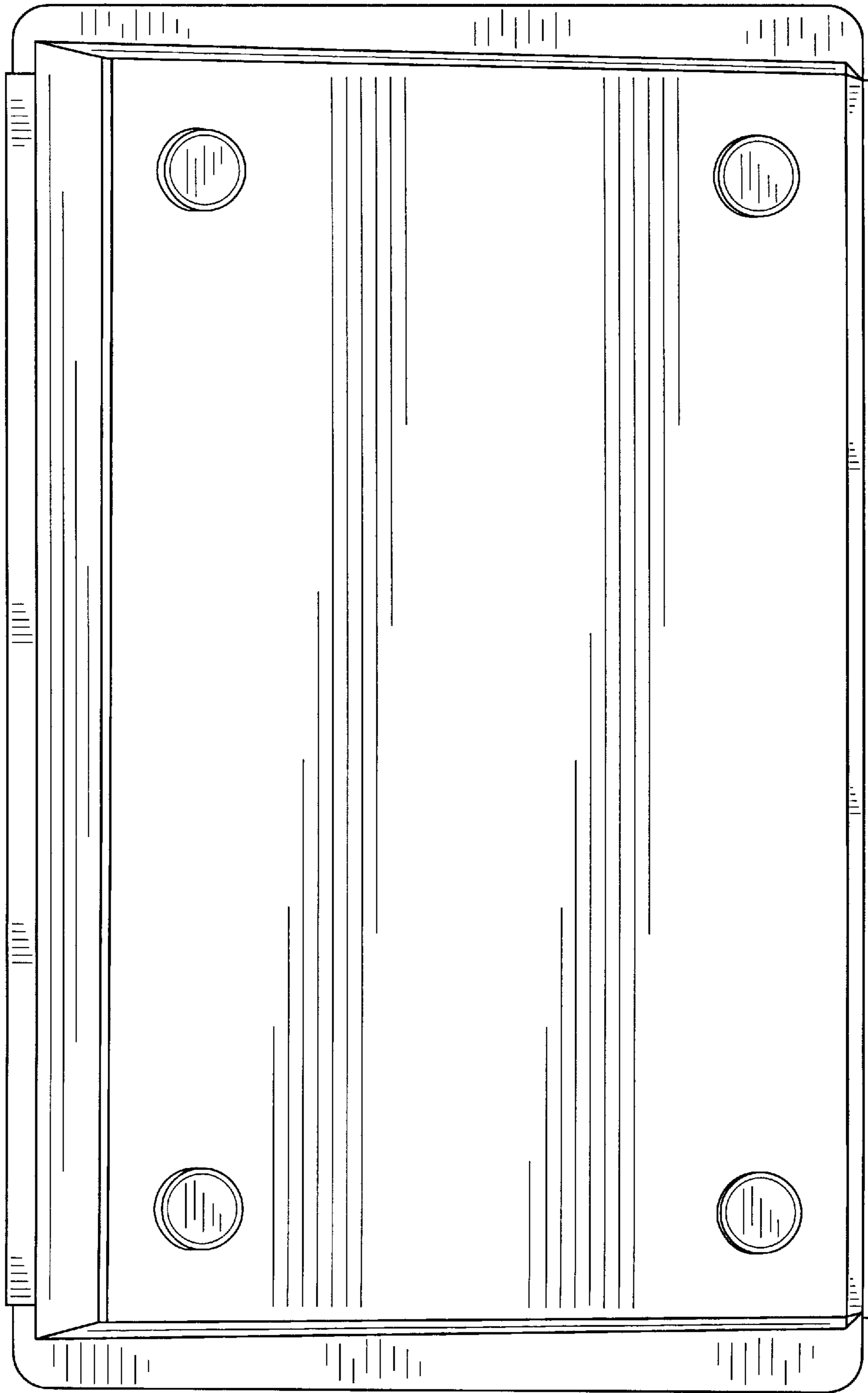

FIG. 7

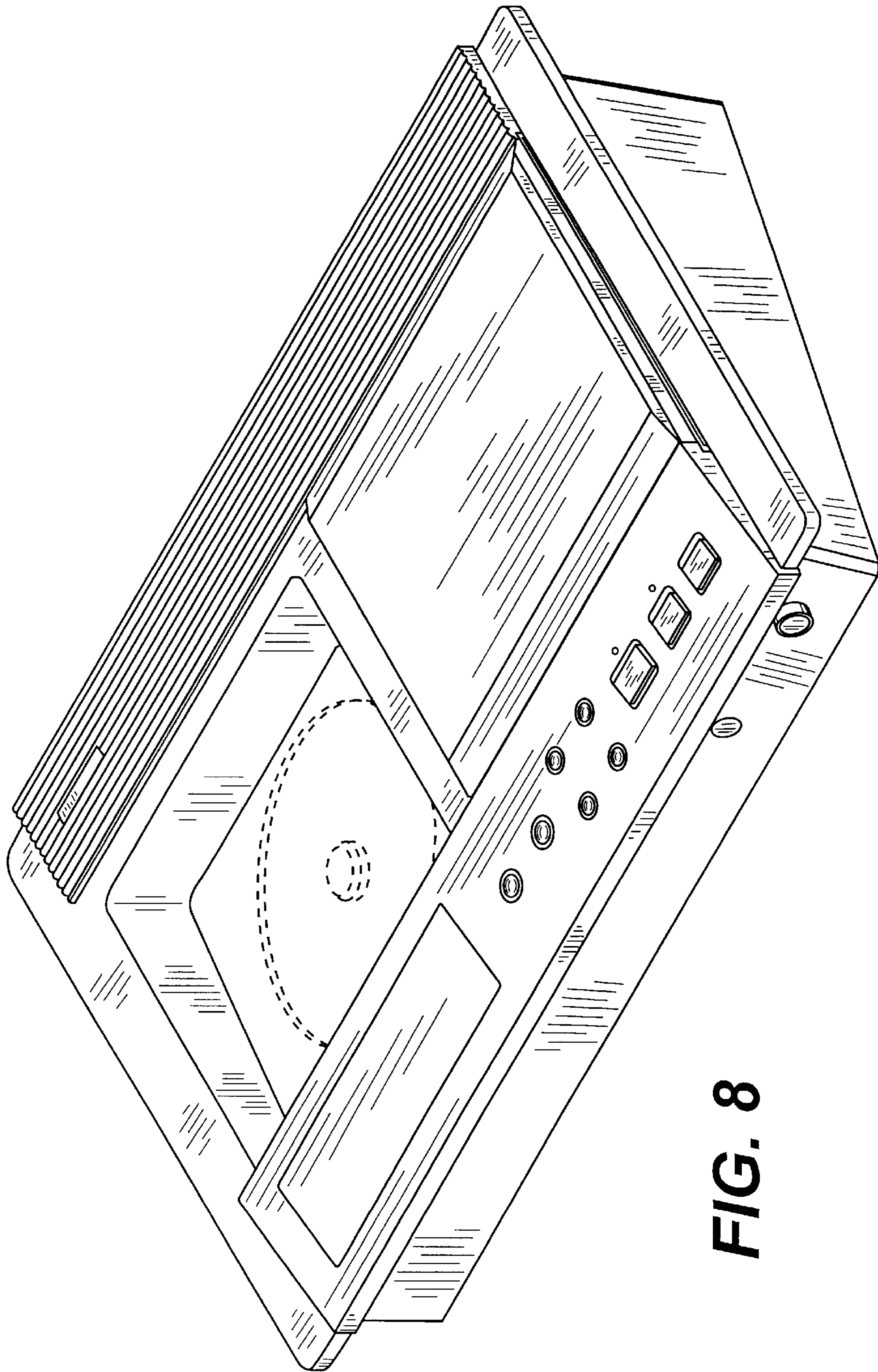

FIG. 8