



US00D421332S

# United States Patent [19] Krulik

[11] **Patent Number: Des. 421,332**  
[45] **Date of Patent: \*\* Mar. 7, 2000**

[54] **WHEELED CATALOG CASE**

[75] Inventor: **Richard J. Krulik**, Dix Hills, N.Y.

[73] Assignee: **United States Luggage, L.P.**,  
Hauppauge, N.Y.

[\*\*] Term: **14 Years**

[21] Appl. No.: **29/086,979**

[22] Filed: **Apr. 23, 1998**

[51] **LOC (6) Cl. .... 03-01**

[52] **U.S. Cl. .... D3/276; D3/276**

[58] **Field of Search .... D3/273, 276, 279;**  
190/18 A, 110, 111, 112, 113, 114, 115

[56] **References Cited**

**U.S. PATENT DOCUMENTS**

D. 352,395	11/1994	King	.....	D3/279
D. 354,396	1/1995	Löwenstein	.....	D3/276
D. 354,397	1/1995	Berman	.....	D3/276
D. 354,398	1/1995	Berman	.....	D3/276
D. 357,808	5/1995	Aumasson	.....	D3/276
D. 364,504	11/1995	Bieber et al.	.....	D3/276
D. 381,511	7/1997	Krulik	.....	D3/279
5,291,976	3/1994	Ku	.....	190/18 A
5,310,031	5/1994	Plath	.....	190/18 A
5,435,423	7/1995	Rekuc et al.	.....	190/18 A
5,474,162	12/1995	Shyr et al.	.....	190/18 A

**OTHER PUBLICATIONS**

Service Merchandise Catalog, pp.391 through 395, Wheeled Luggage, 1997.

*Primary Examiner*—Philip S. Hyder  
*Attorney, Agent, or Firm*—Abelman, Frayne & Schwab

[57] **CLAIM**

I claim the ornamental design for a wheeled catalog case, as shown and described.

**DESCRIPTION**

FIG. 1 is a perspective view of a first embodiment of the wheeled catalog case;  
FIG. 2 is a top plan view thereof;  
FIG. 3 is a front elevation view thereof;  
FIG. 4 is a right-hand side elevation thereof;  
FIG. 5 is a left-hand side elevation thereof;  
FIG. 6 is a rear elevation thereof;  
FIG. 7 is an underside plan view thereof;  
FIG. 8 is a perspective view of a second embodiment of the wheeled catalog case;  
FIG. 9 is a top plan view thereof;  
FIG. 10 is a front elevation view thereof;  
FIG. 11 is a right-hand side elevation thereof;  
FIG. 12 is a left-hand side elevation thereof;  
FIG. 13 is a rear elevation thereof; and,  
FIG. 14 is an underside plan view thereof.

**1 Claim, 8 Drawing Sheets**

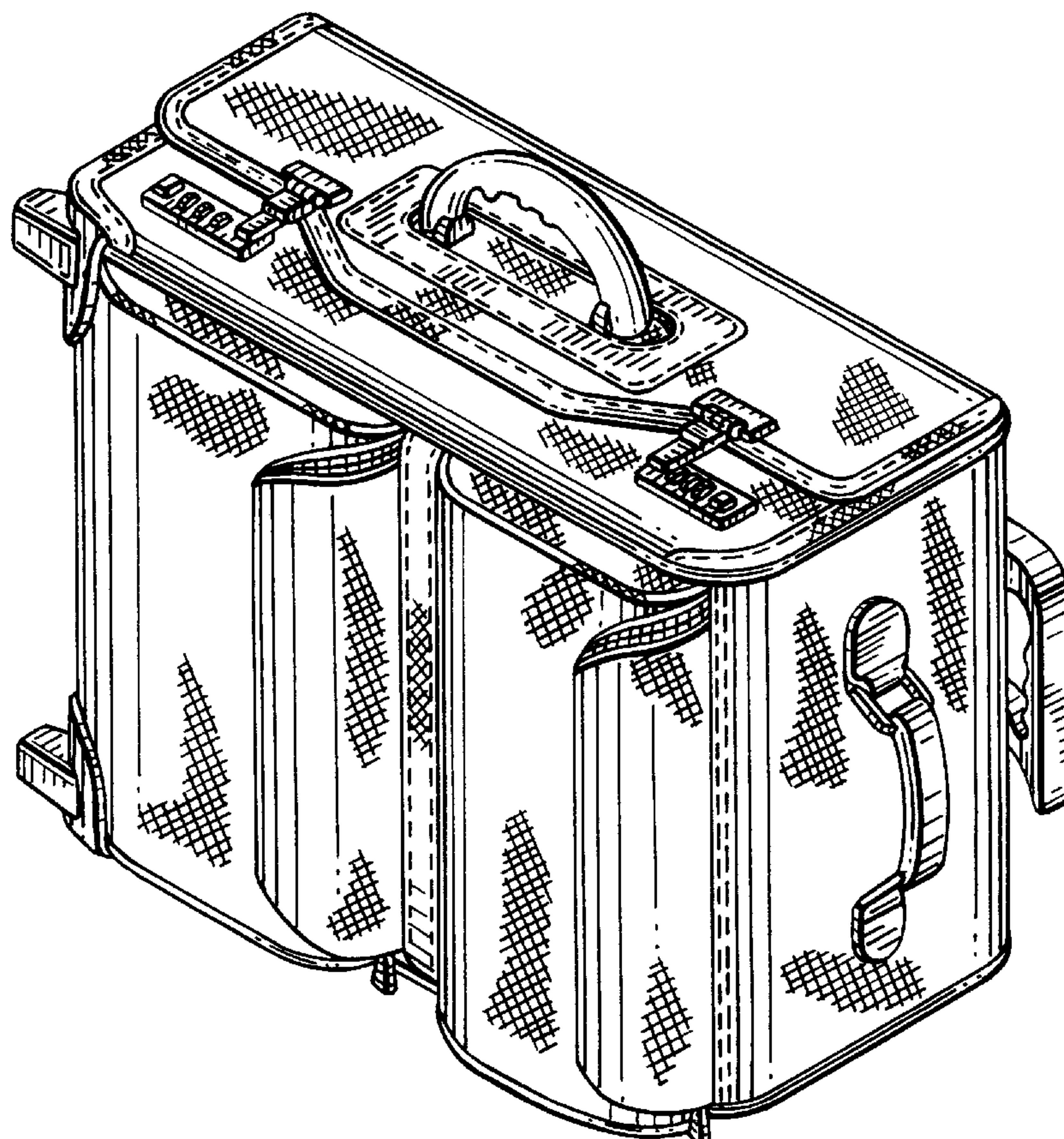

*FIG. 1*

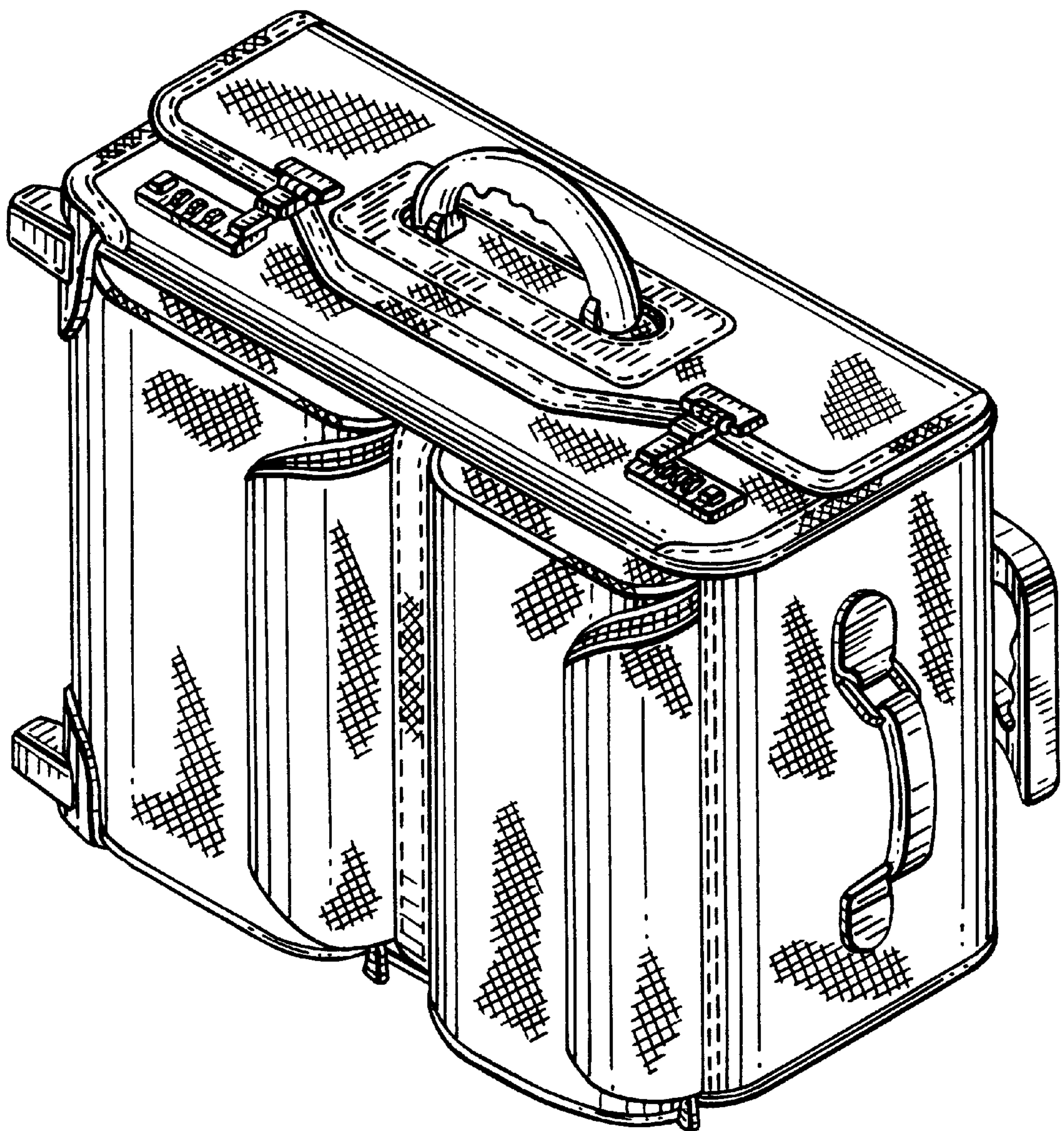



FIG. 2

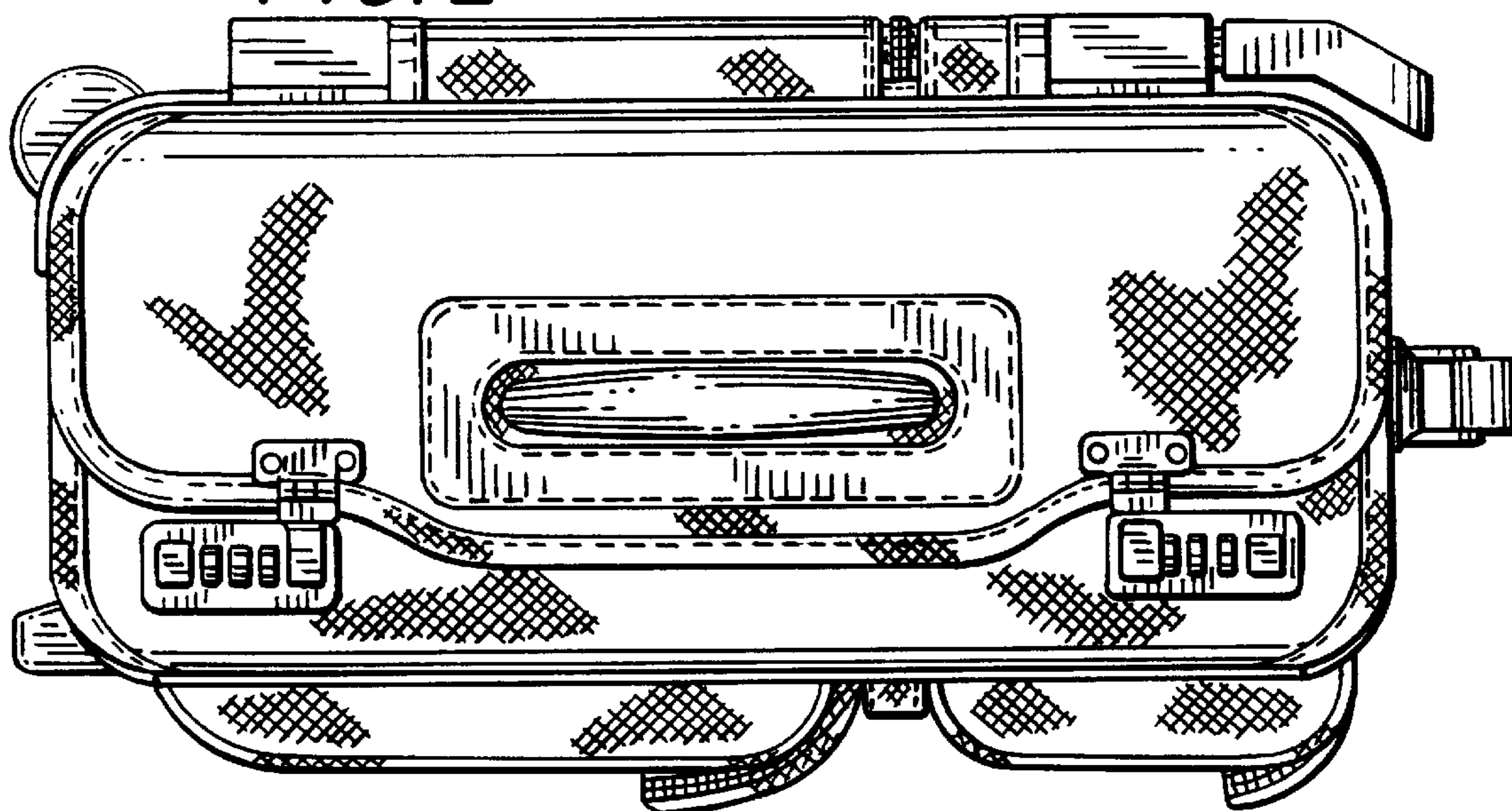

FIG. 3

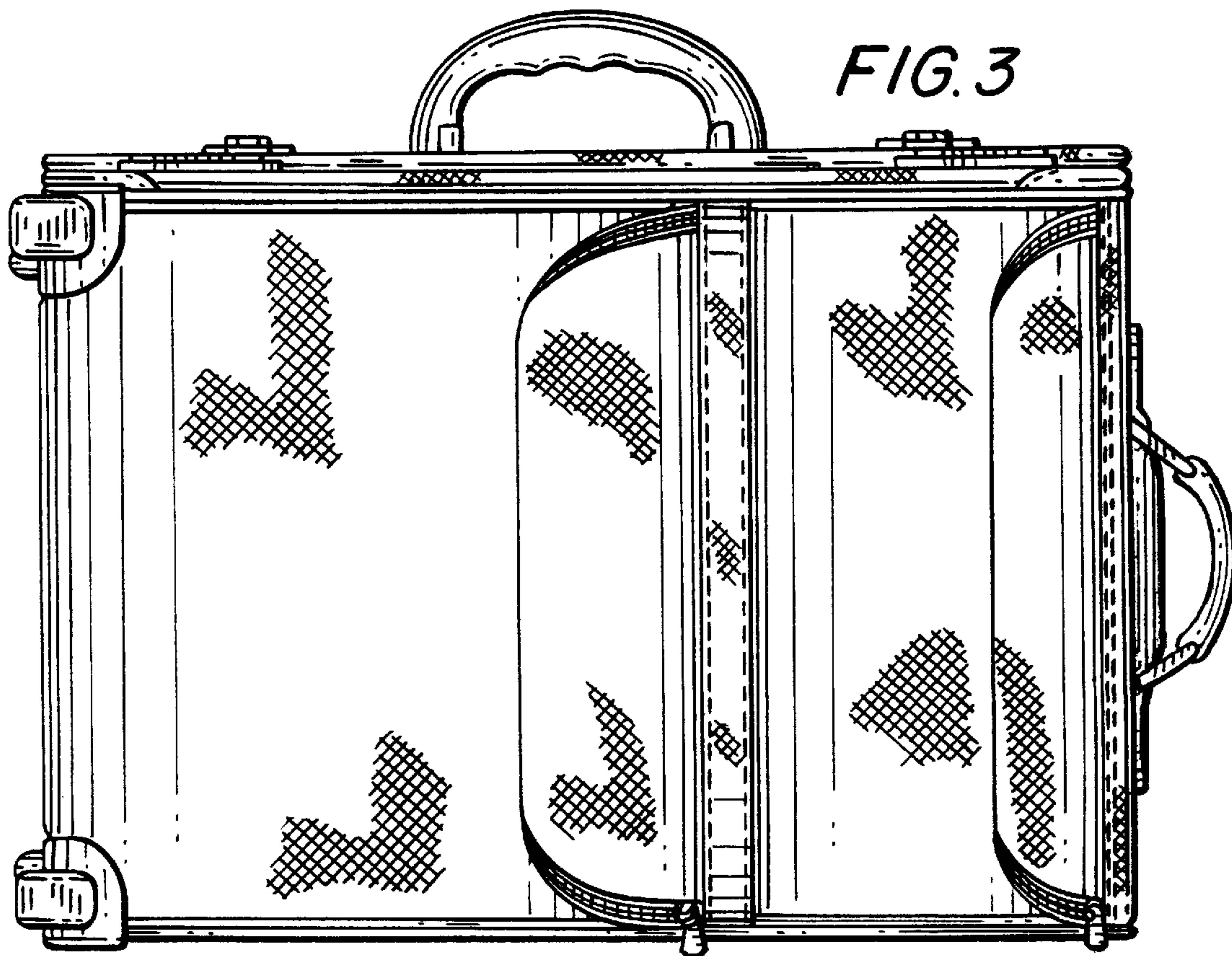

FIG. 5

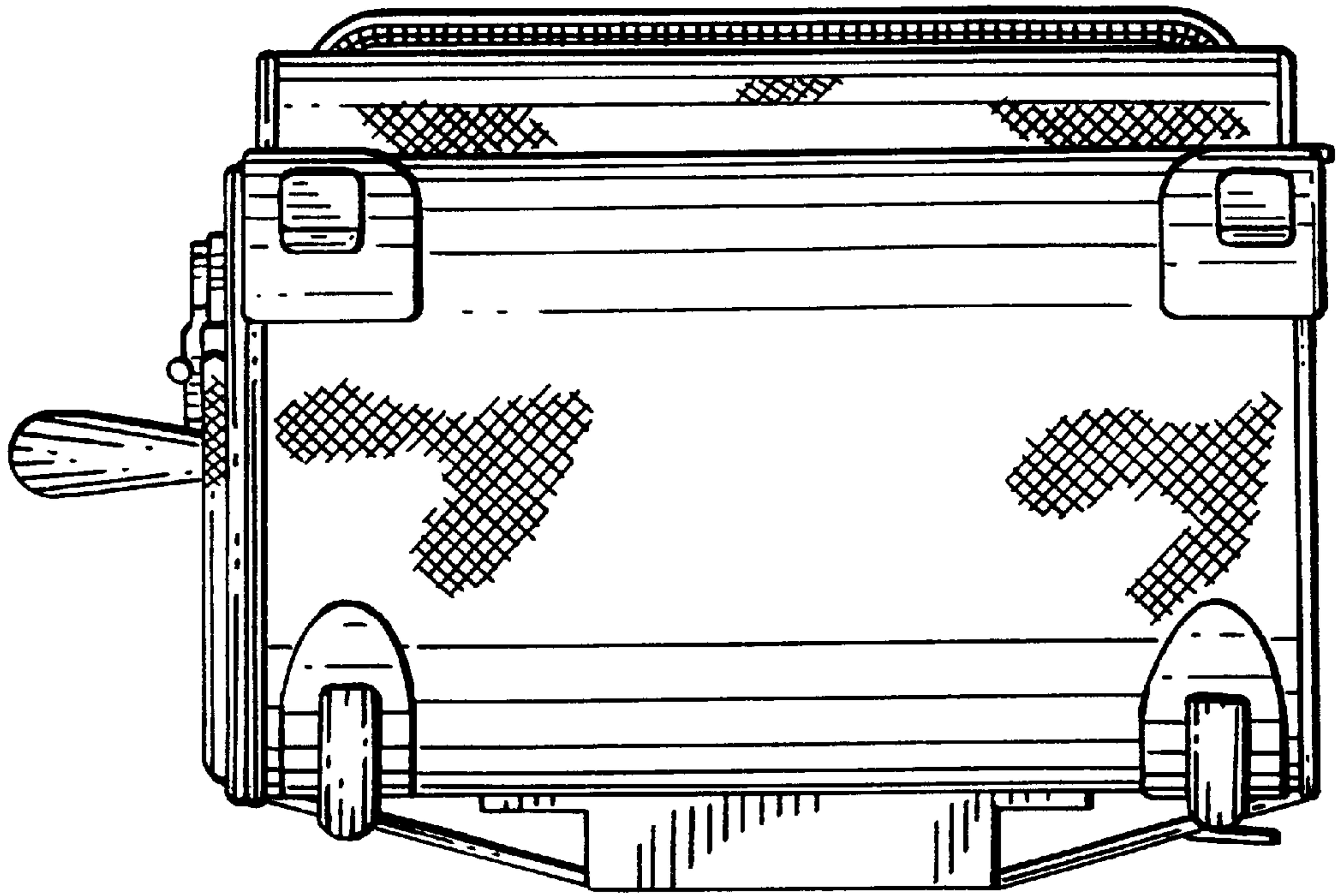

FIG. 4

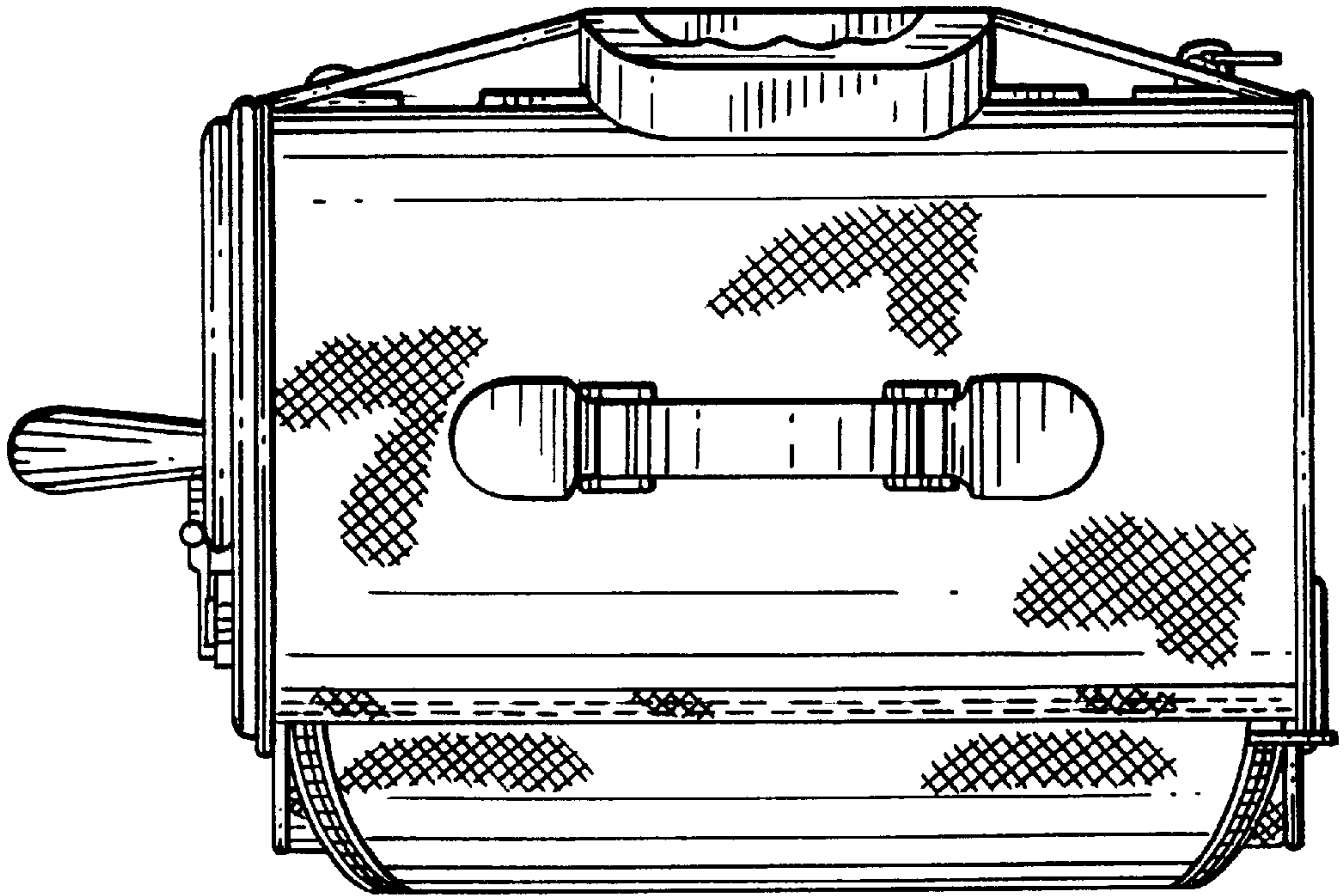



FIG. 6

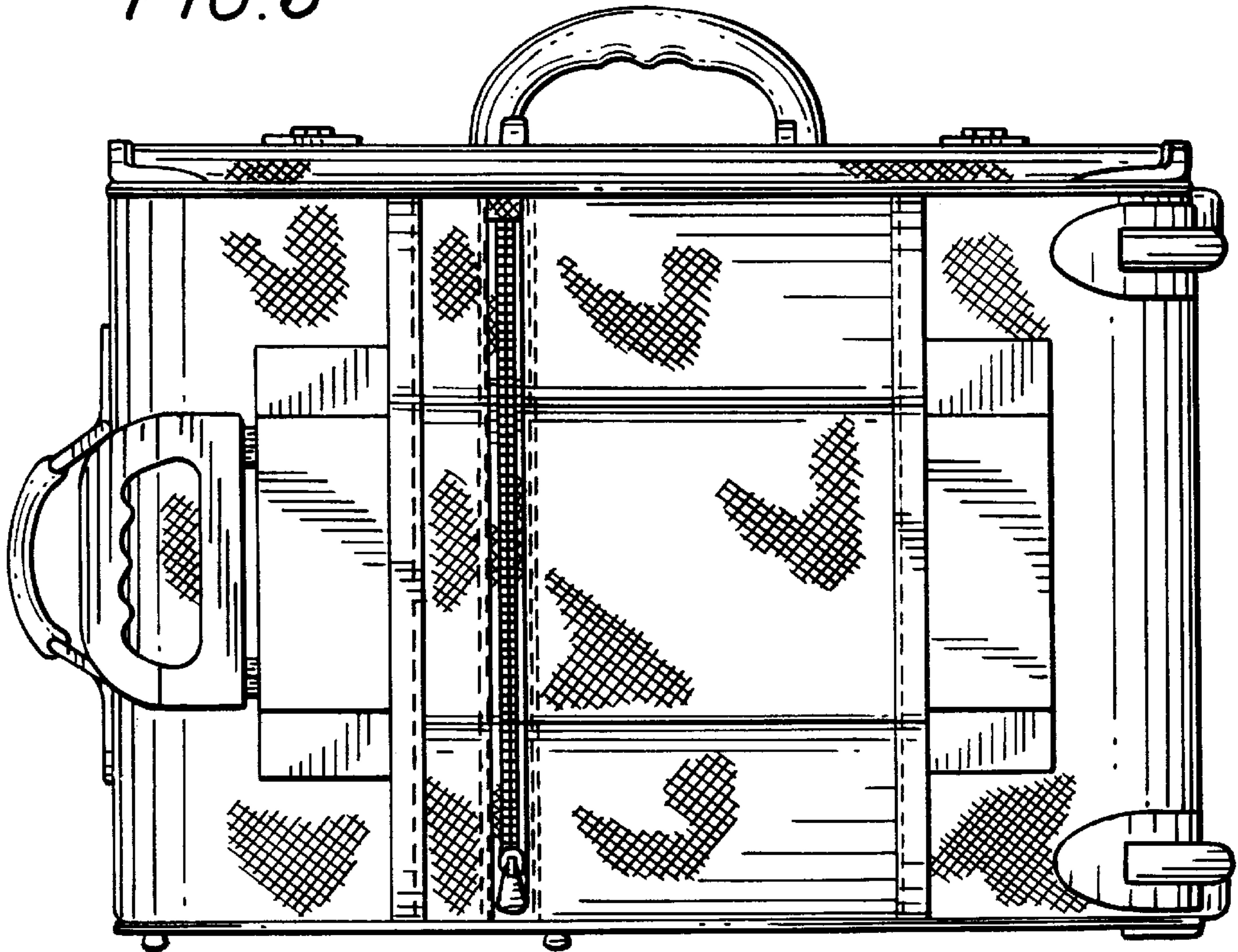
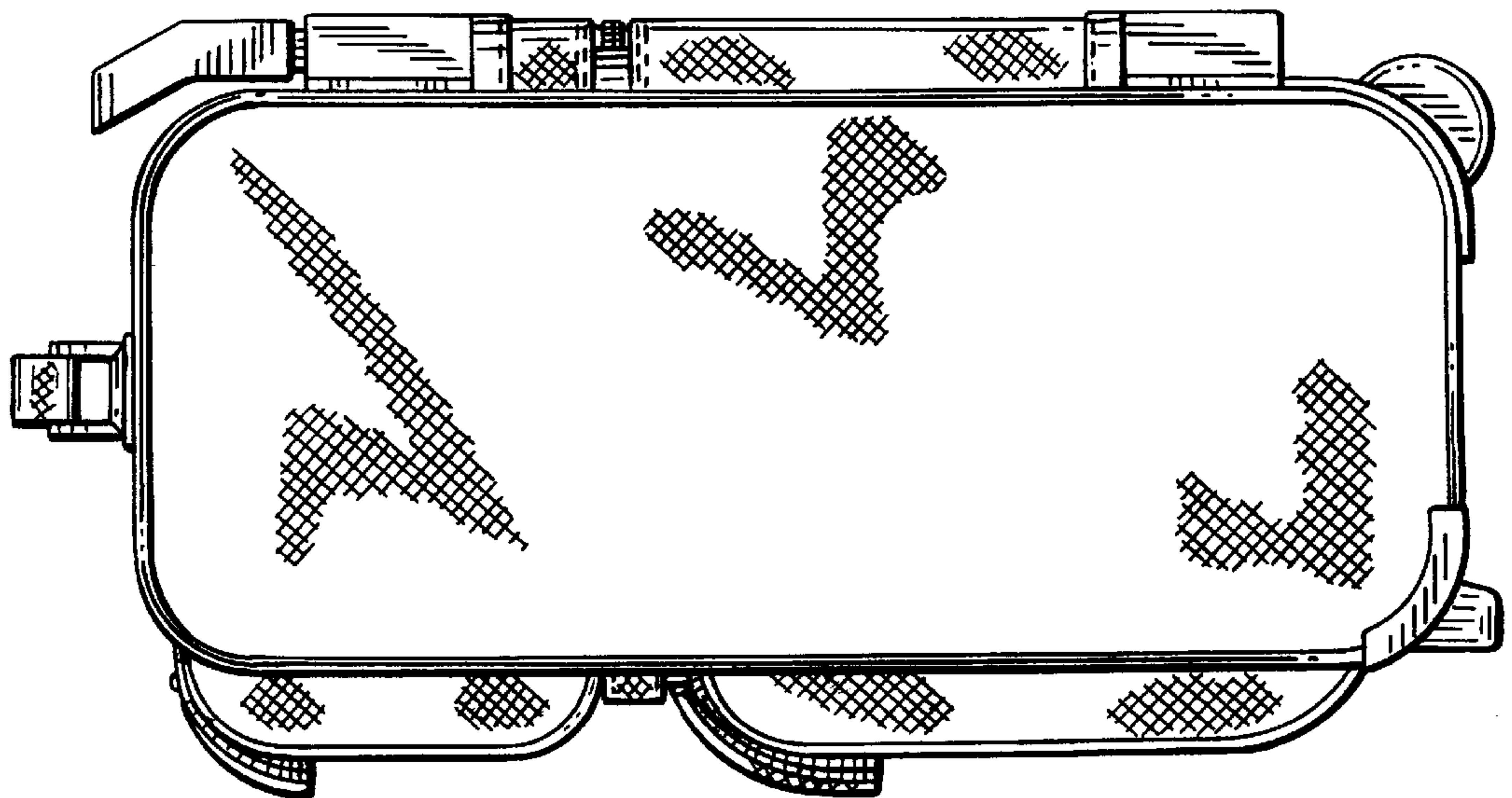

FIG. 7



*FIG. 8*

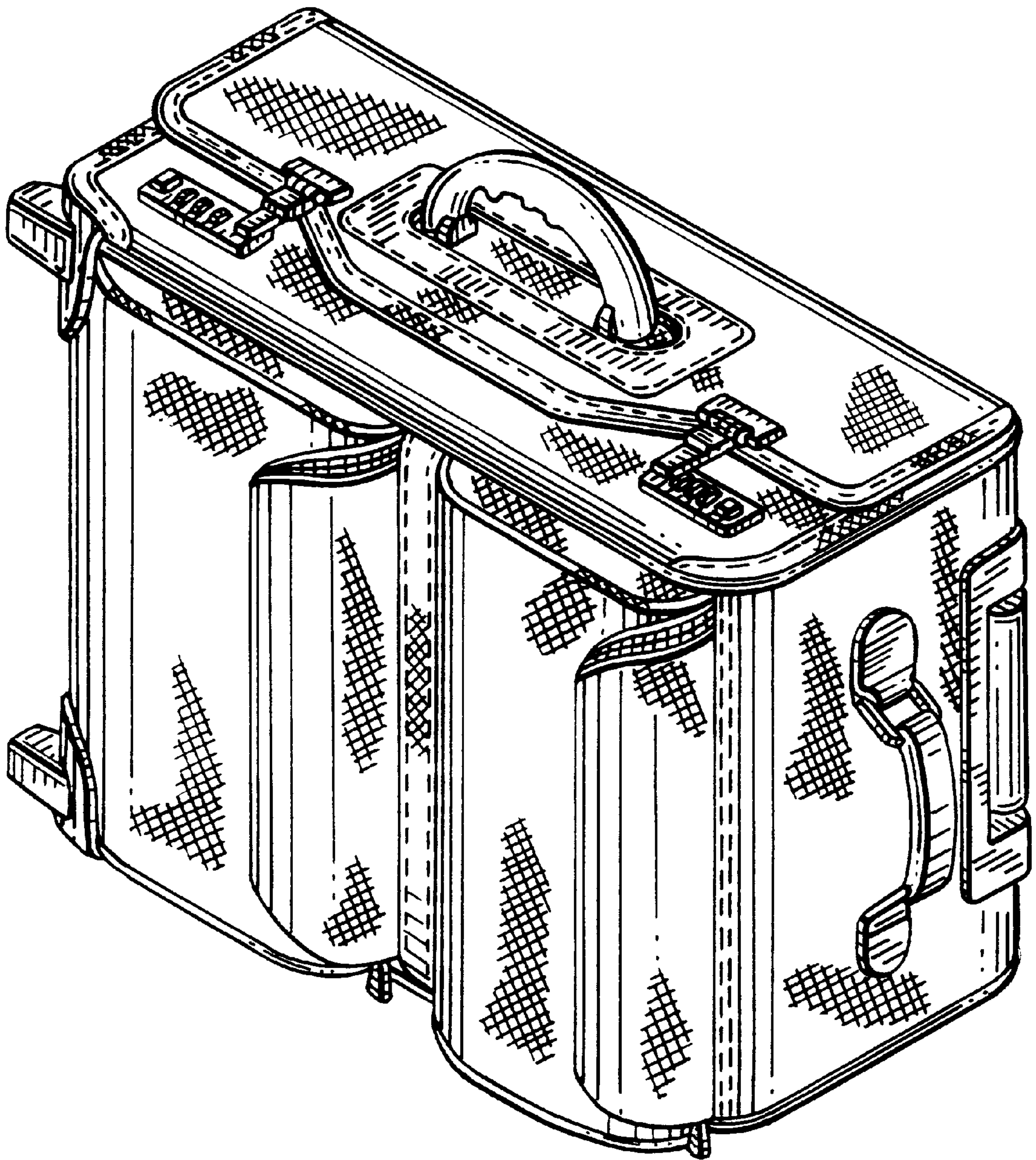



FIG. 9

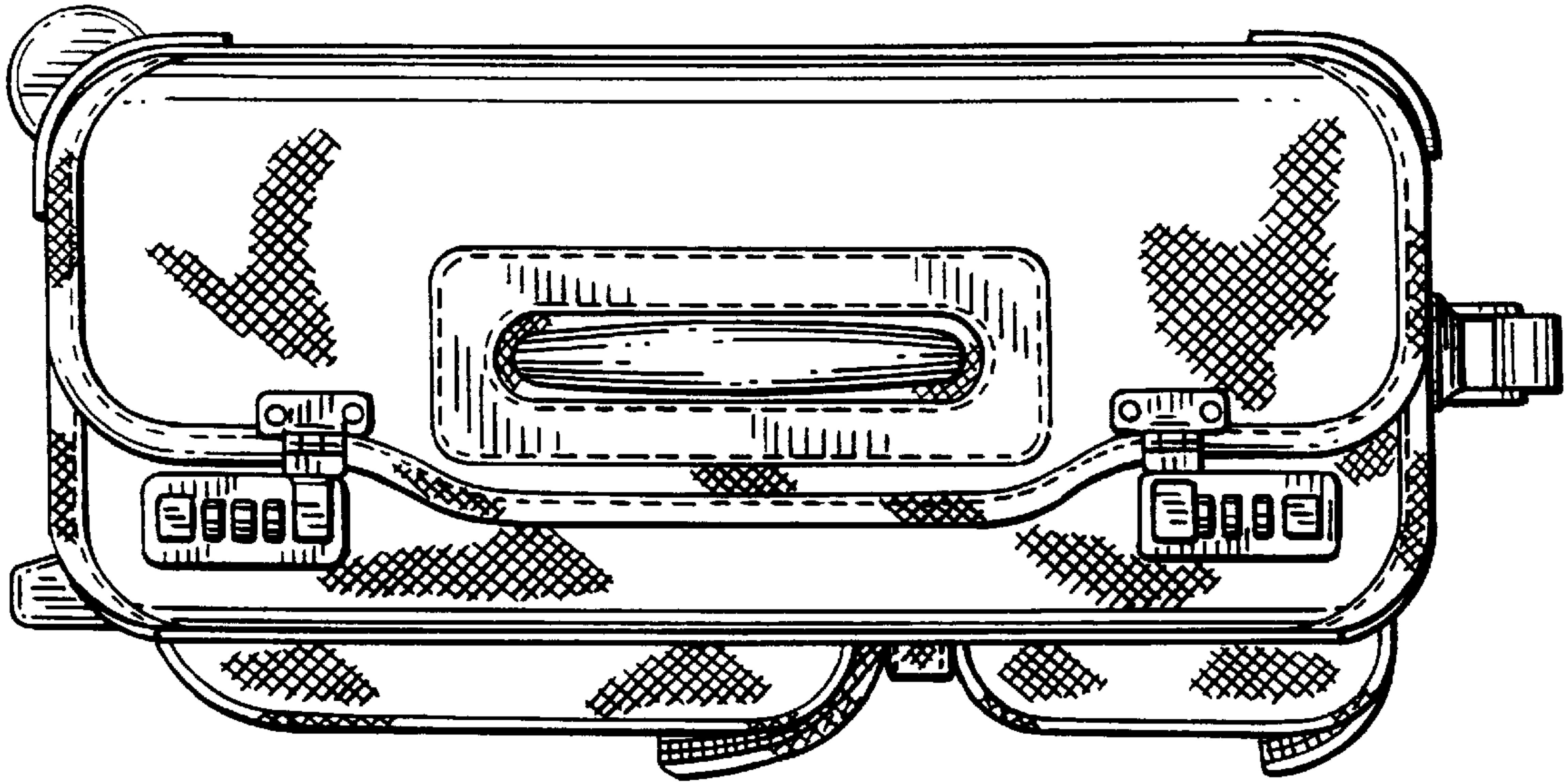

FIG. 10

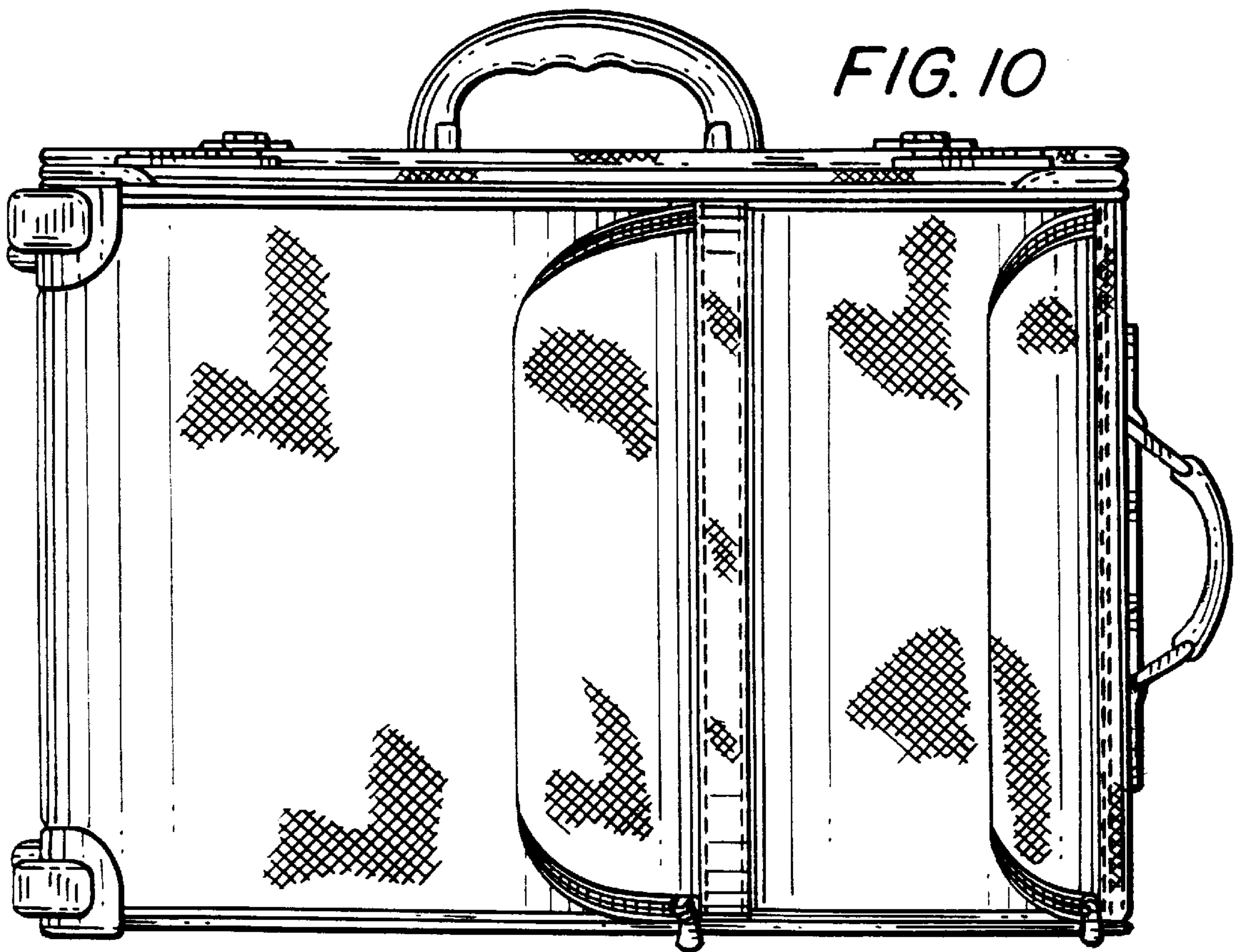

FIG. 12

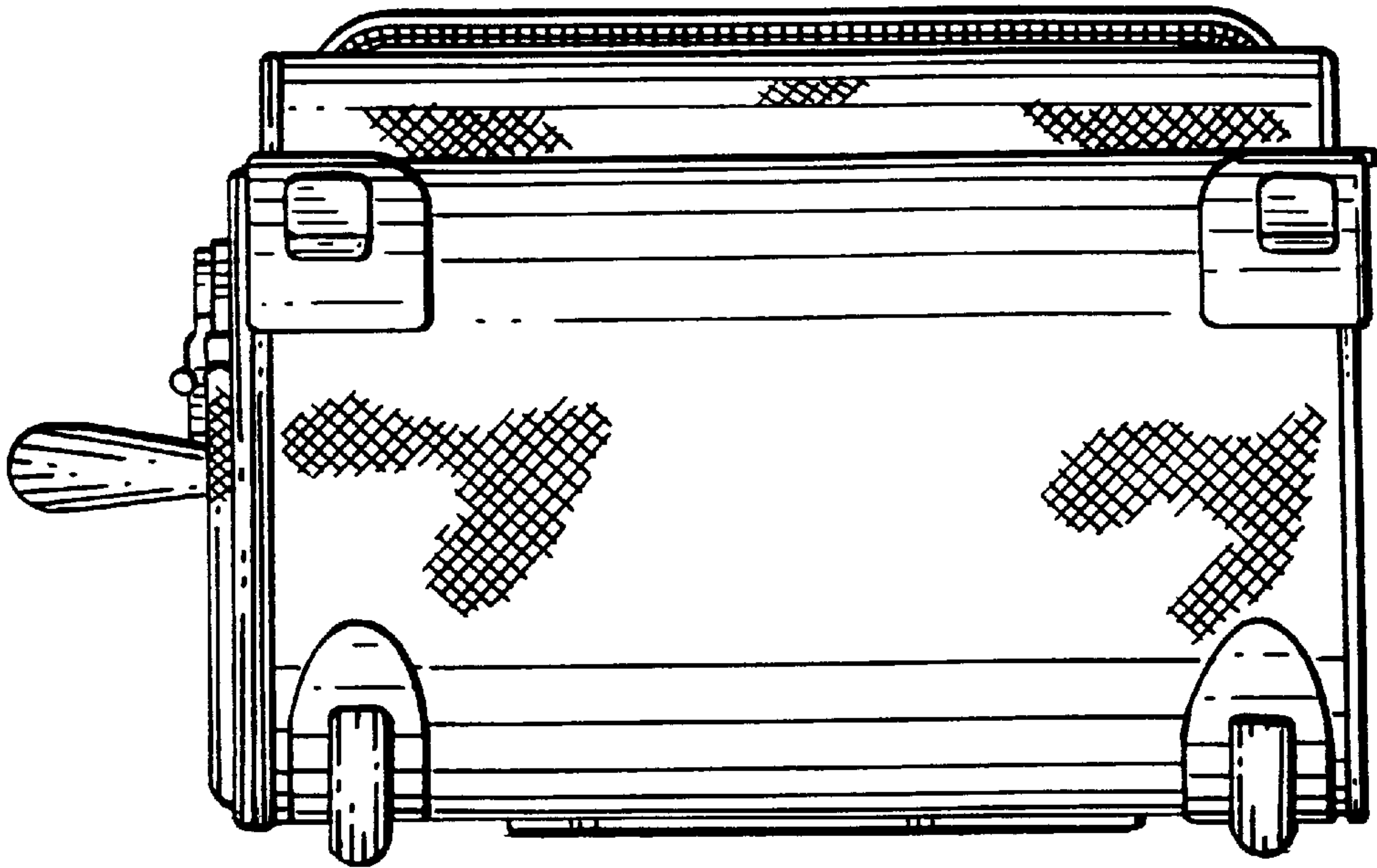

FIG. 11

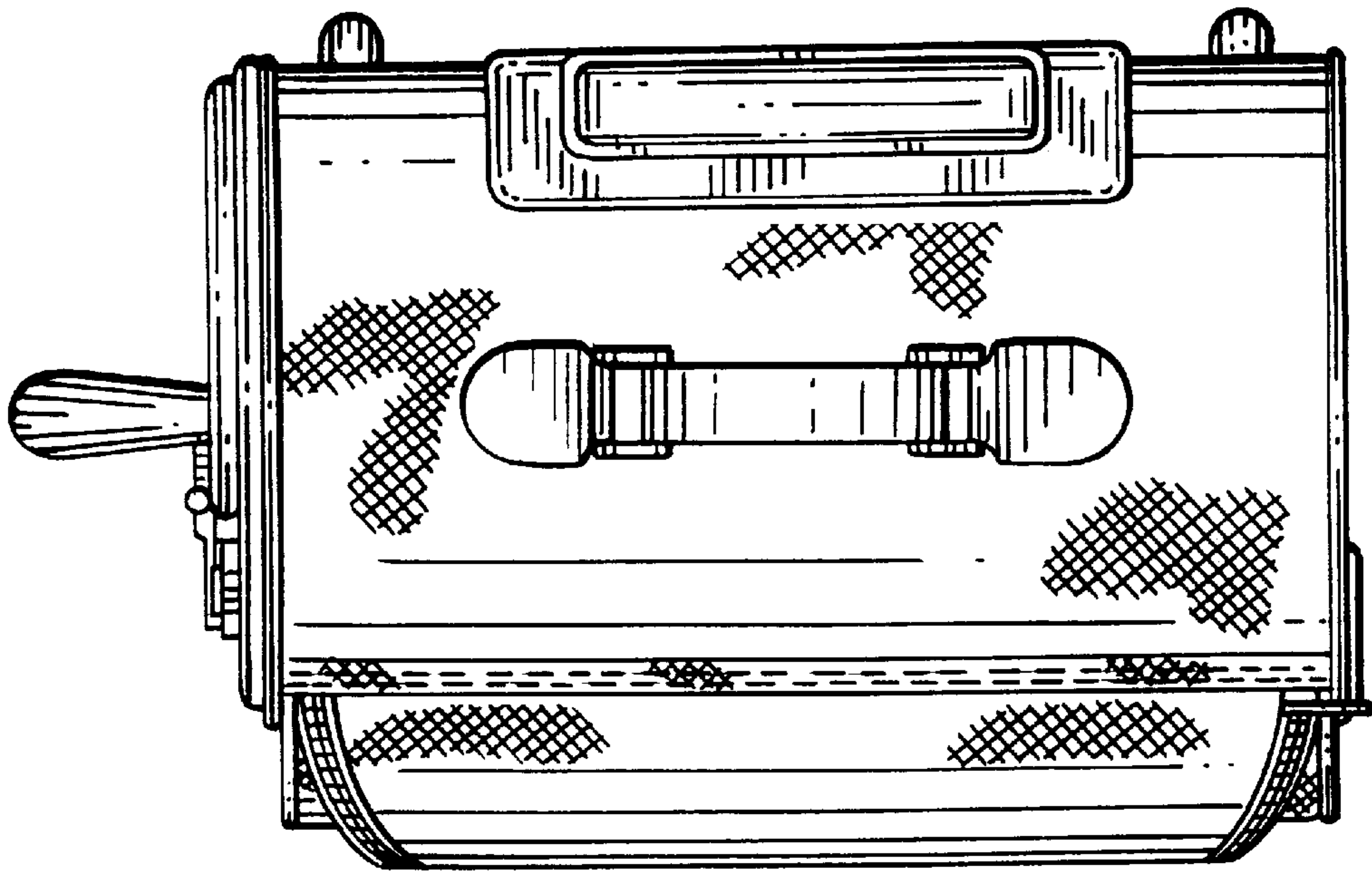



FIG. 13

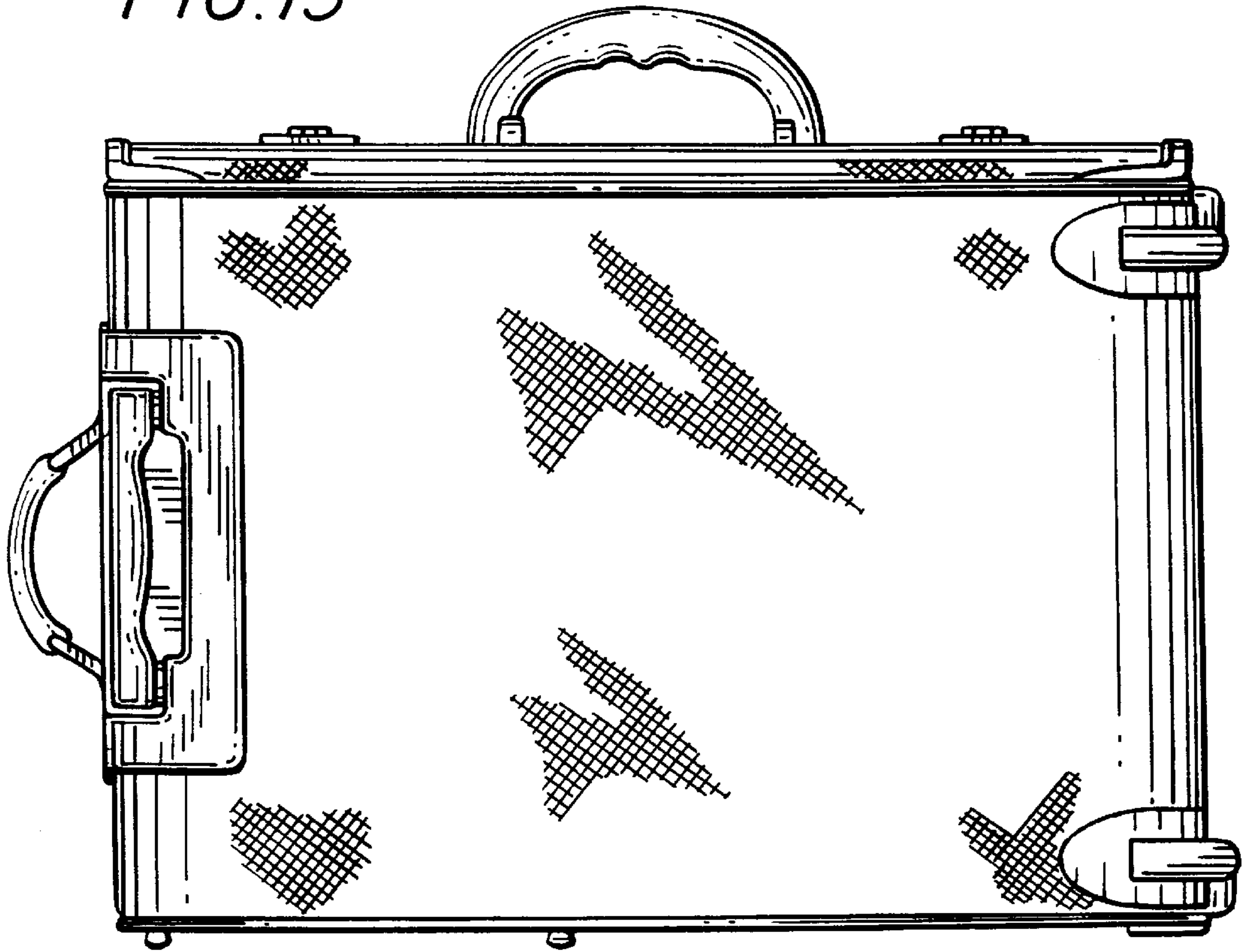

FIG. 14

