



US00D421310S

**United States Patent** [19]  
**Shantz**

[11] **Patent Number: Des. 421,310**

[45] **Date of Patent: \*\* Feb. 29, 2000**

[54] **VESSEL FOR AN ANALYTIC TEST DEVICE**

[76] Inventor: **Janet Shantz**, 6040 Belmont NE.,  
Belmont, Mich. 49306

[\*\*] Term: **14 Years**

[21] Appl. No.: **29/090,021**

[22] Filed: **Jun. 29, 1998**

[51] **LOC (6) Cl.** ..... **24-04**

[52] **U.S. Cl.** ..... **D24/223**

[58] **Field of Search** ..... D24/224, 223,  
D24/225; 436/814, 906; 422/58, 68.1; D10/81

[56] **References Cited**

**U.S. PATENT DOCUMENTS**

D. 348,522	7/1994	Groothuizen .....	D24/223
D. 369,868	5/1996	Nazareth et al. ....	D24/225
D. 379,662	6/1997	Pearson et al. ....	D24/223
D. 379,663	6/1997	Pearson et al. ....	D24/223
D. 383,549	9/1997	Arnett et al. ....	D24/223
4,857,453	8/1989	Ullman et al. .	
4,981,786	1/1991	Dafforn et al. ....	435/7
5,017,342	5/1991	Haberzettl et al. ....	422/102

*Primary Examiner*—Stella Reid  
*Attorney, Agent, or Firm*—Young & Basile, P.C.

[57] **CLAIM**

The ornamental design for the vessel for an analytic test device, as shown and described.

**DESCRIPTION**

FIG. 1 is a top perspective view of a vessel for an analytic

test device, showing my new design with the cover and body in separated condition;

FIG. 2 is a top elevational view thereof showing the cover portion thereof mated to a first end of the body portion thereof;

FIG. 3 is a bottom elevational view thereof showing the cover portion thereof mated to a first end of the body portion thereof;

FIG. 4 is a side elevational view thereof showing the cover portion thereof mated to a first end of the body portion thereof, the opposite side elevational view being identical thereto;

FIG. 5 is an elevational view of the first end of said body portion thereof;

FIG. 6 is an elevational view of the second end of said body portion thereof;

FIG. 7 is an elevational view of one end of said cover portion thereof;

FIG. 8 is an elevational view of the opposite end of said cover portion thereof.

FIG. 9 is a top elevational view thereof showing the cover portion thereof mated to the second end of the body portion thereof;

FIG. 10 is a bottom elevational view thereof showing the cover portion thereof mated to the second end of the body portion thereof; and,

FIG. 11 is a side elevational view thereof showing the cover portion thereof mated to the second end of the body portion thereof, the opposite side elevational view being identical thereto.

The broken line showing is for illustrative purposes only and forms no part of the claimed design.

**1 Claim, 3 Drawing Sheets**

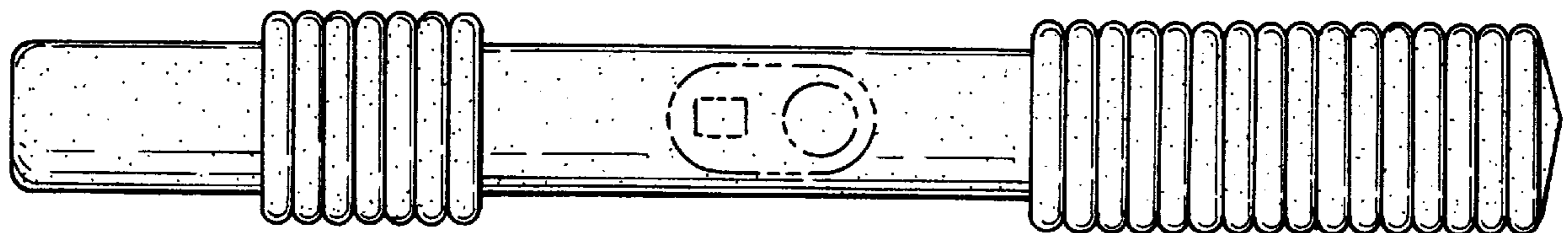

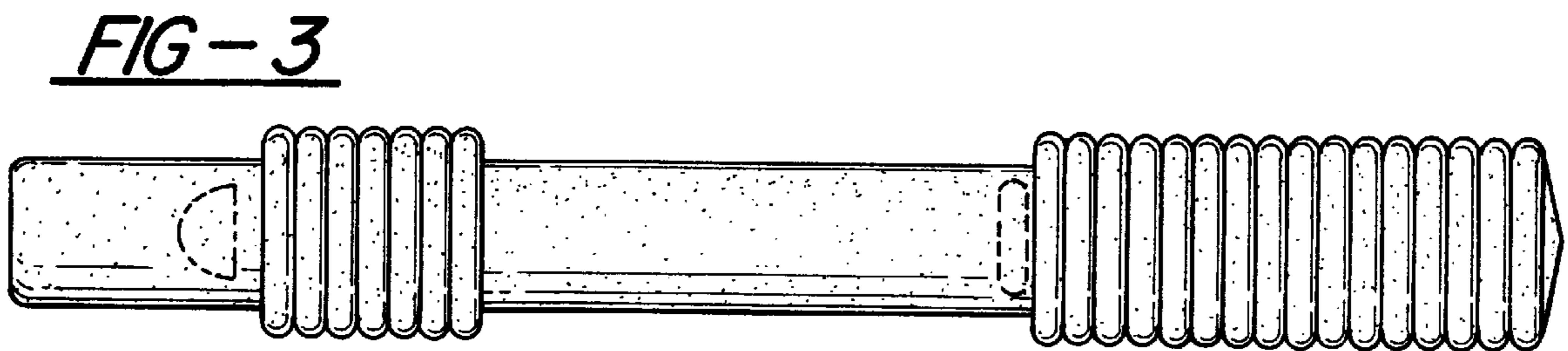
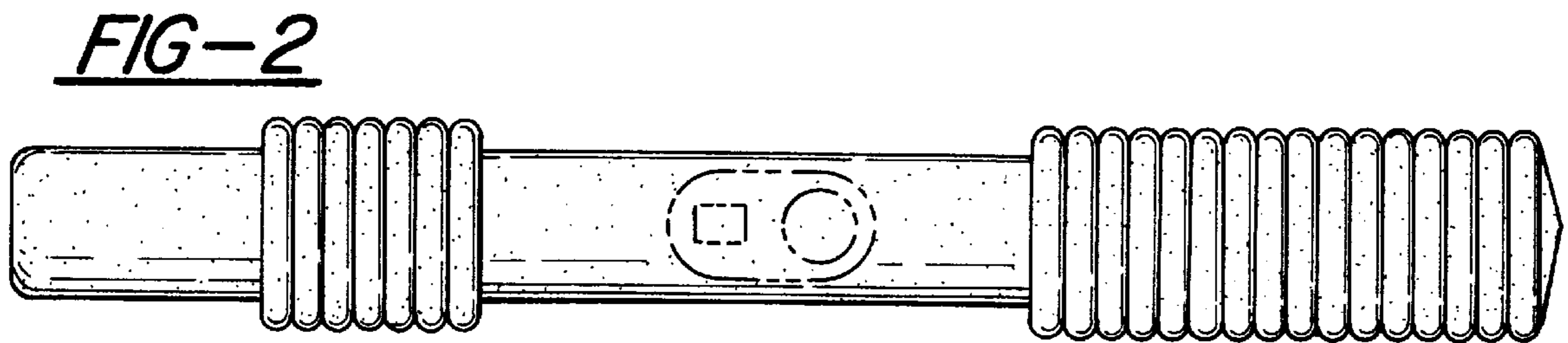
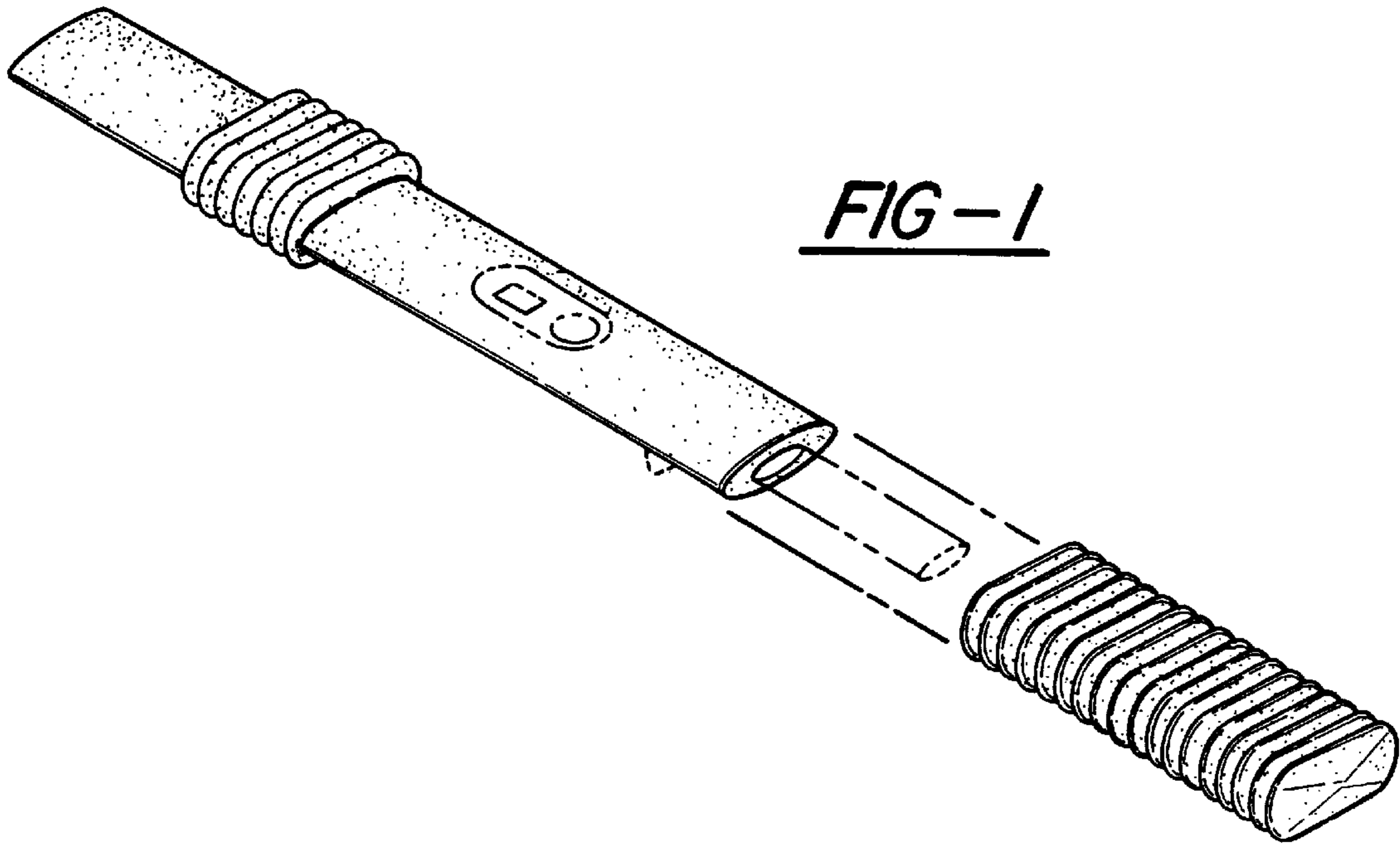

FIG-4

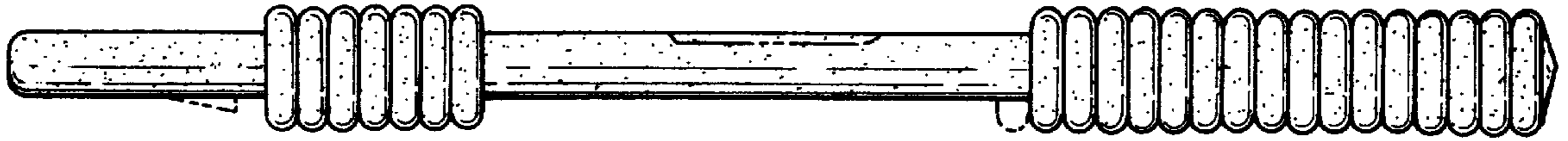

FIG-5

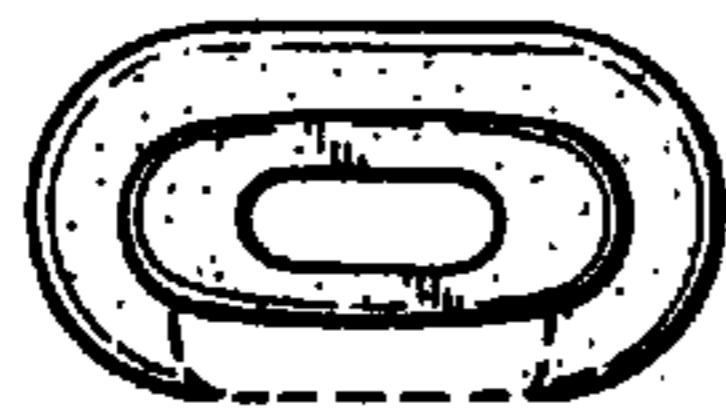

FIG-6

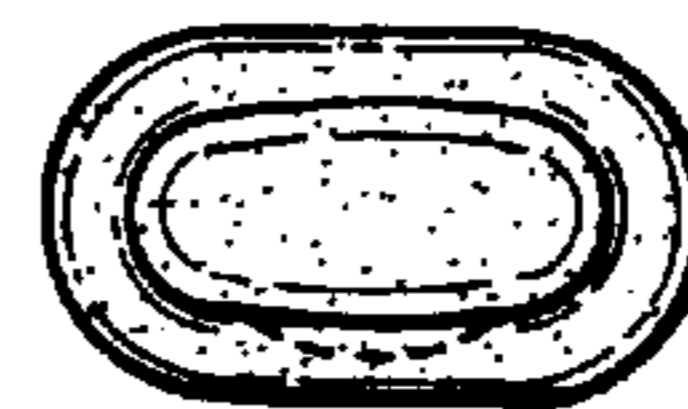

FIG-7

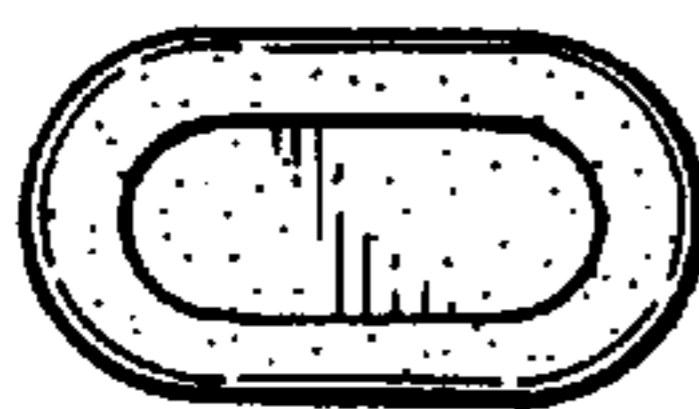
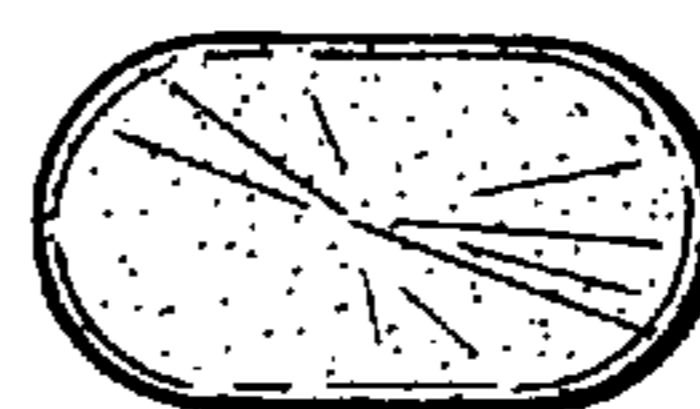

FIG-8



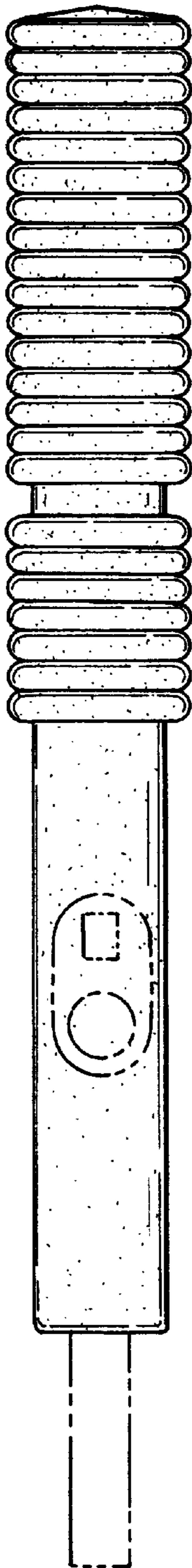

FIG-9

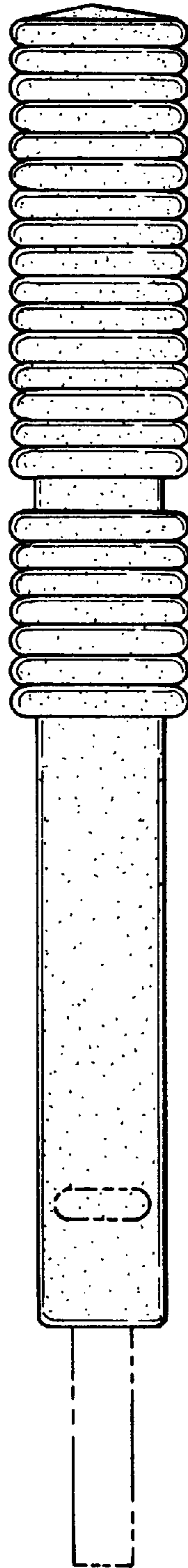

FIG-10

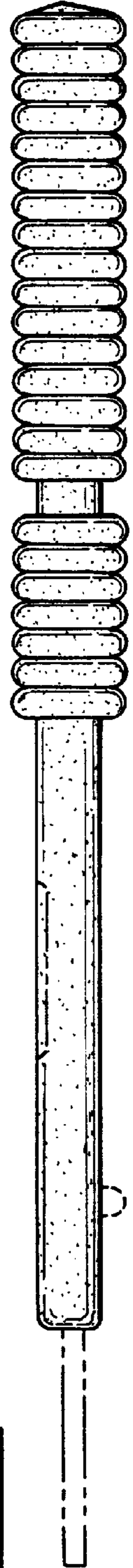

FIG-11