



US00D421299S

# United States Patent [19]

Brostrom et al.

[11] Patent Number: **Des. 421,299**

[45] Date of Patent: **\*\* Feb. 29, 2000**

[54] **CARRIAGE FOR DROP-DOWN MASK ASSEMBLY**

5,592,937 1/1997 Freund ..... 128/206.18

### FOREIGN PATENT DOCUMENTS

[75] Inventors: **Gerald M. Brostrom**, Burnsville, Minn.; **David C. Byram**, River Falls, Wis.

0085746 8/1983 European Pat. Off. .

195 16 859

A1 11/1995 Germany .

34-12900 8/1959 Japan .

WO 86/01734 3/1986 WIPO .

[73] Assignee: **3M Innovative Properties Company**, St. Paul, Minn.

*Primary Examiner*—Stella Reid

*Assistant Examiner*—I Simmons

*Attorney, Agent, or Firm*—James A. Rogers

[\*\*] Term: **14 Years**

[21] Appl. No.: **29/077,631**

### [57] CLAIM

[22] Filed: **Oct. 3, 1997**

The ornamental design for a carriage for drop-down mask assembly, as shown and described.

[51] **LOC (6) Cl.** ..... **29-02**

[52] **U.S. Cl.** ..... **D24/110.1**

[58] **Field of Search** ..... D24/110.1, 110.4, D24/110.5; 128/206.27, 206.28, 207.11, 207.13, 205.25, 207.18, 207.12, 206.26

### DESCRIPTION

FIG. 1 is a perspective view of a carriage for drop-down mask assembly showing our new design; FIG. 2 is a right side elevational view thereof; FIG. 3 is a top plan view thereof; FIG. 4 is a rear elevational view thereof; FIG. 5 is a front elevational view thereof; and, FIG. 6 is a bottom view thereof.

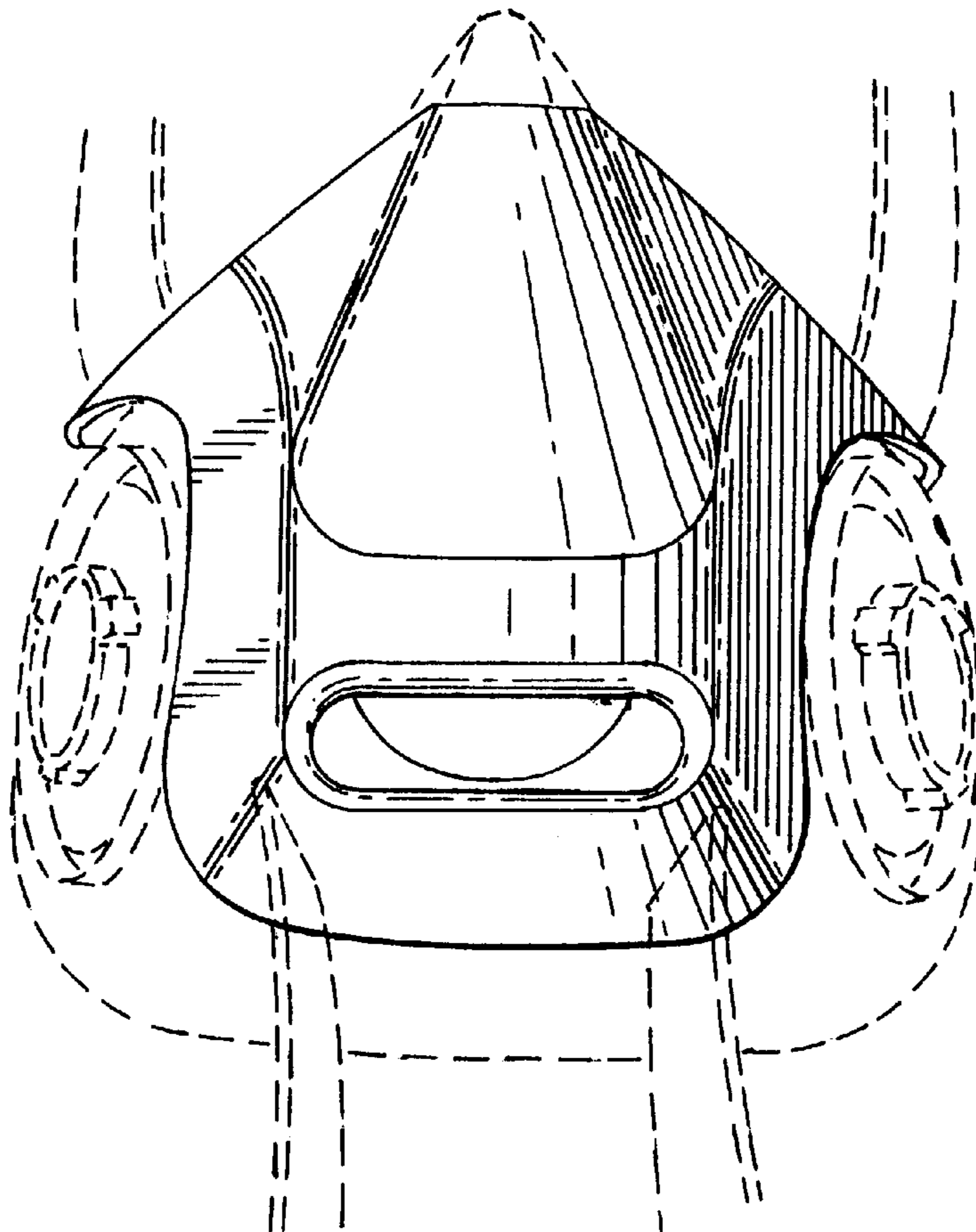
The broken line showing in FIGS. 1, 2, 3, 4 and 6 is for illustrative purposes only and forms no part of the claimed design.

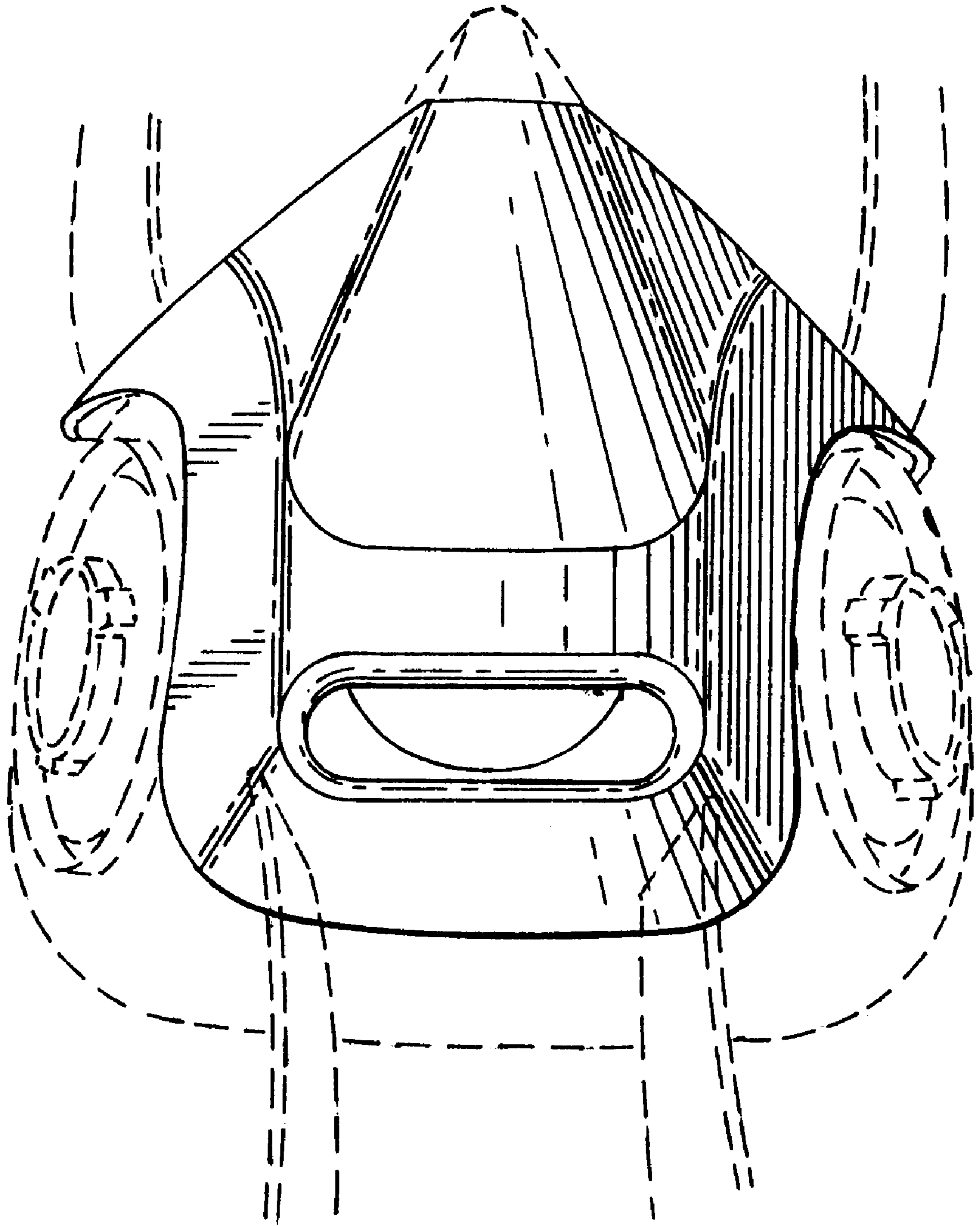
### [56] References Cited

#### U.S. PATENT DOCUMENTS

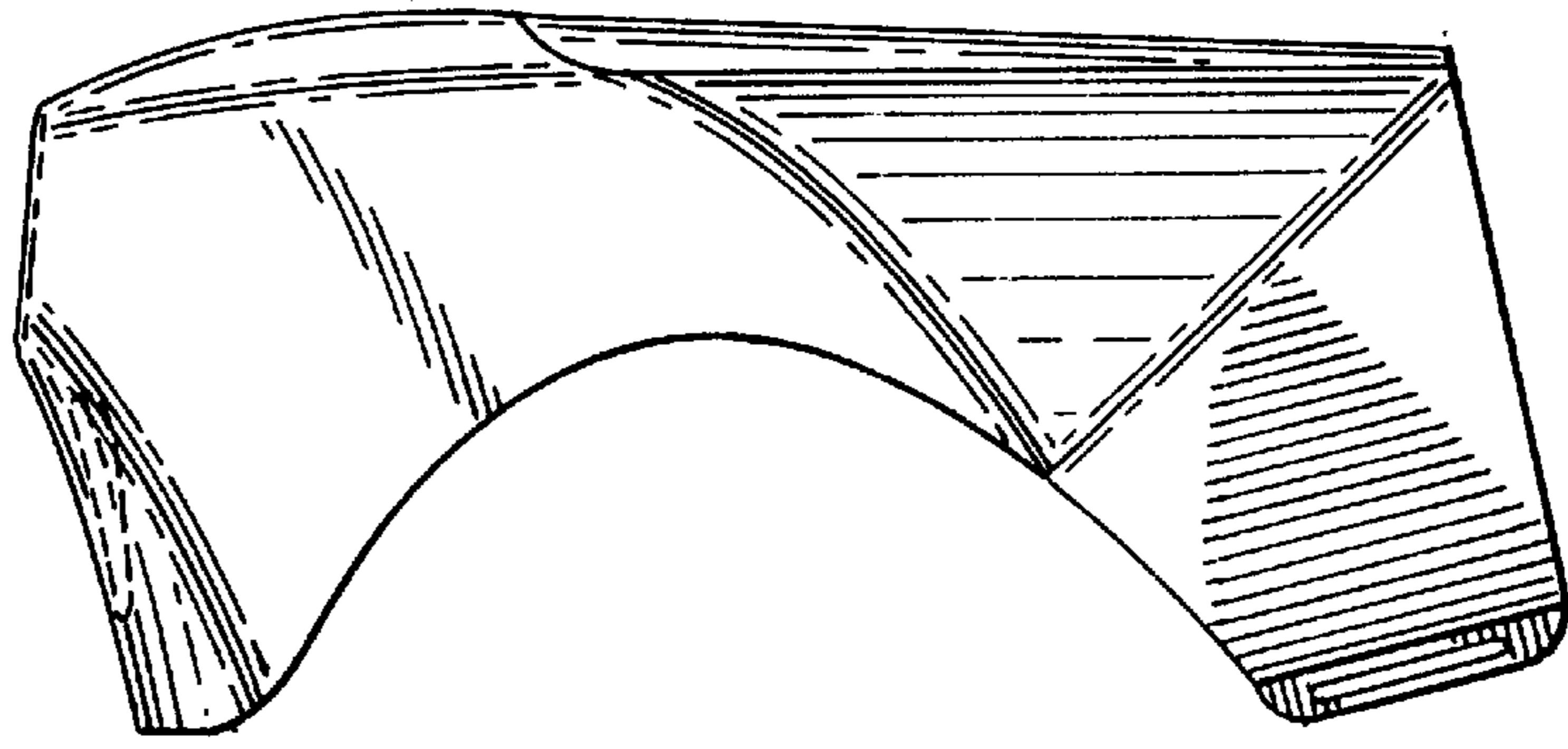
3,792,702	2/1974	Delest	128/146.7
4,934,361	6/1990	Michel et al.	128/206.17
5,062,421	11/1991	Burns et al.	128/205.27
5,181,507	1/1993	Michel et al.	128/206.27
5,237,986	8/1993	Seppala et al.	128/201.23
5,464,010	11/1995	Byram	128/207.11

**1 Claim, 3 Drawing Sheets**

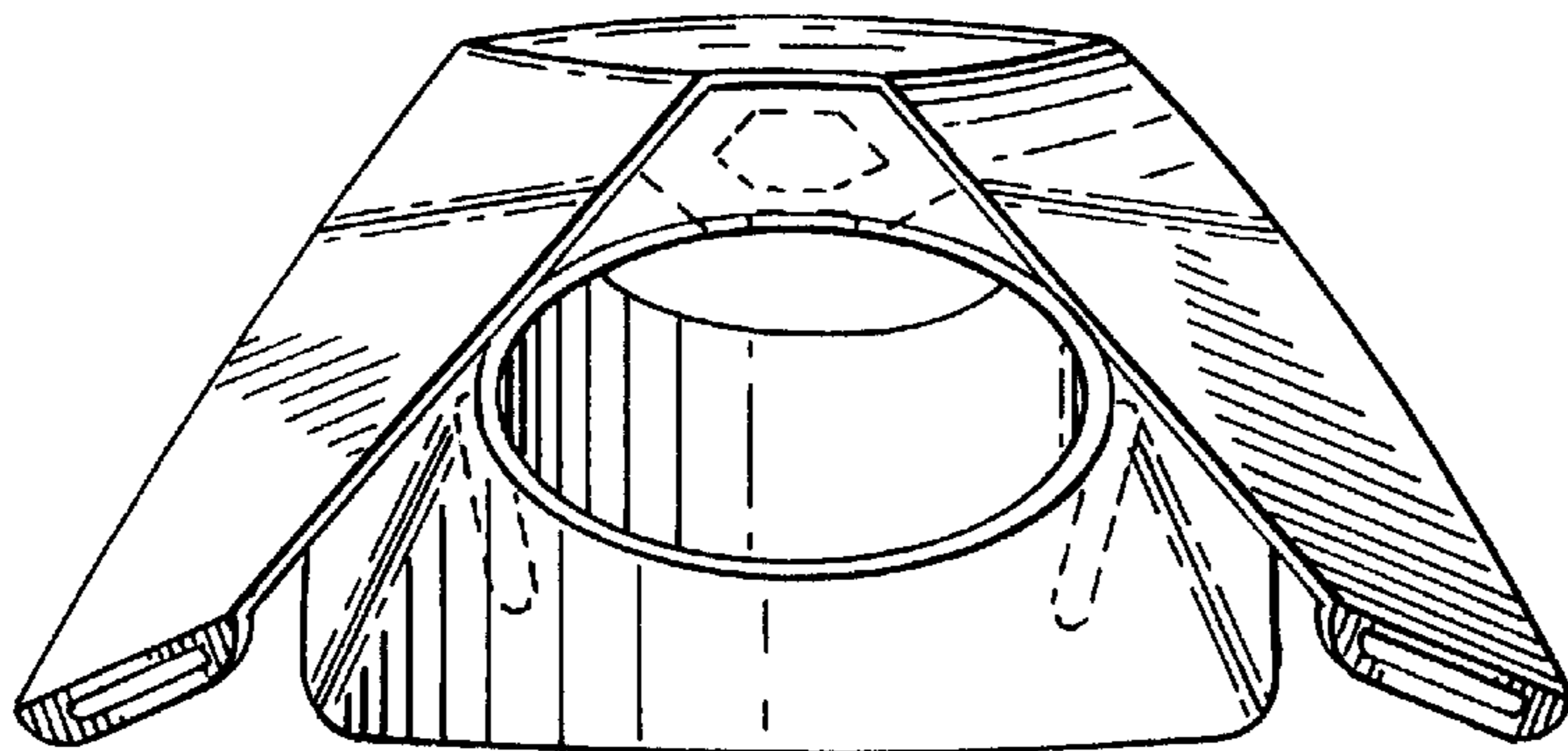




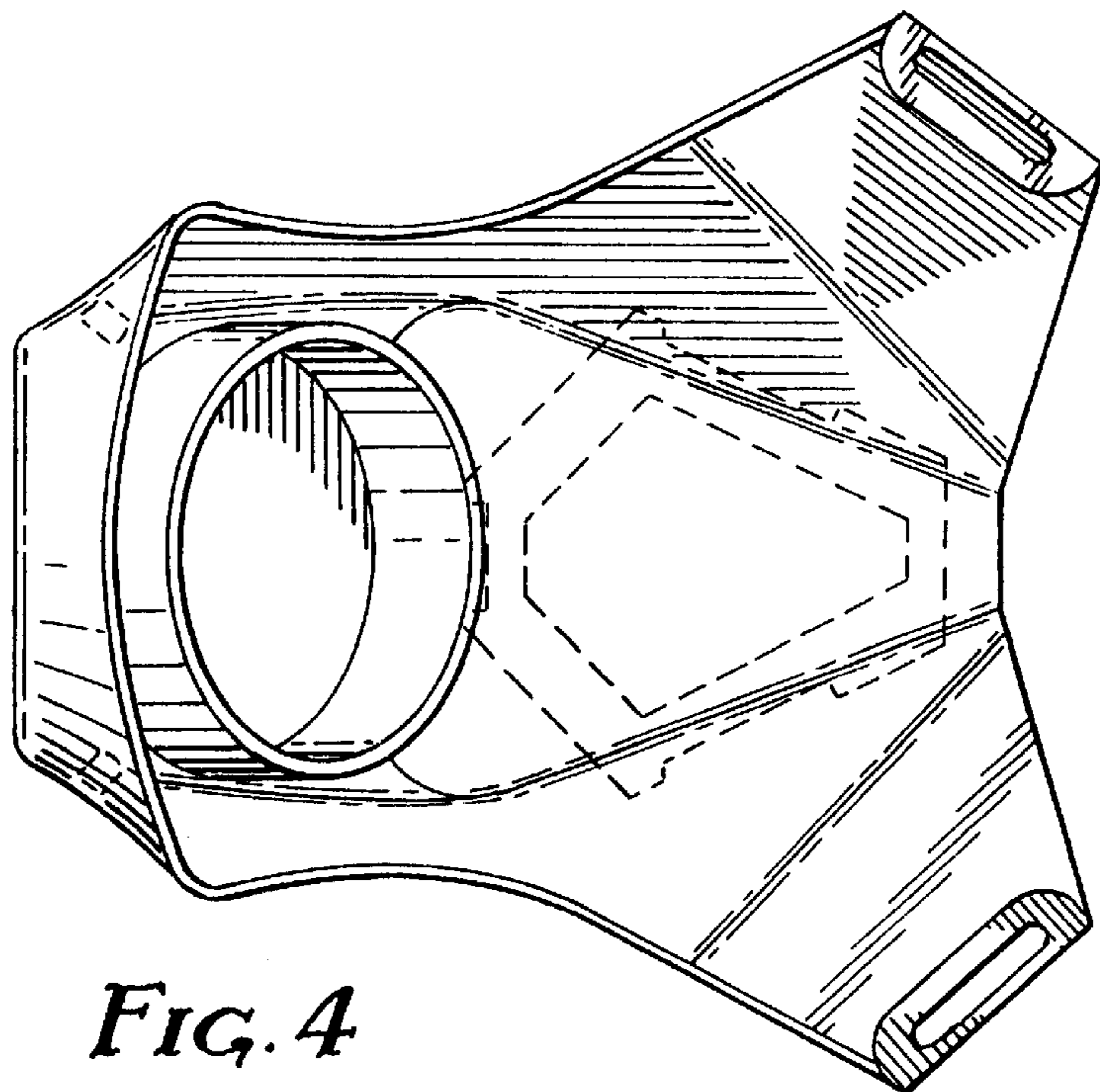
*FIG. 1*



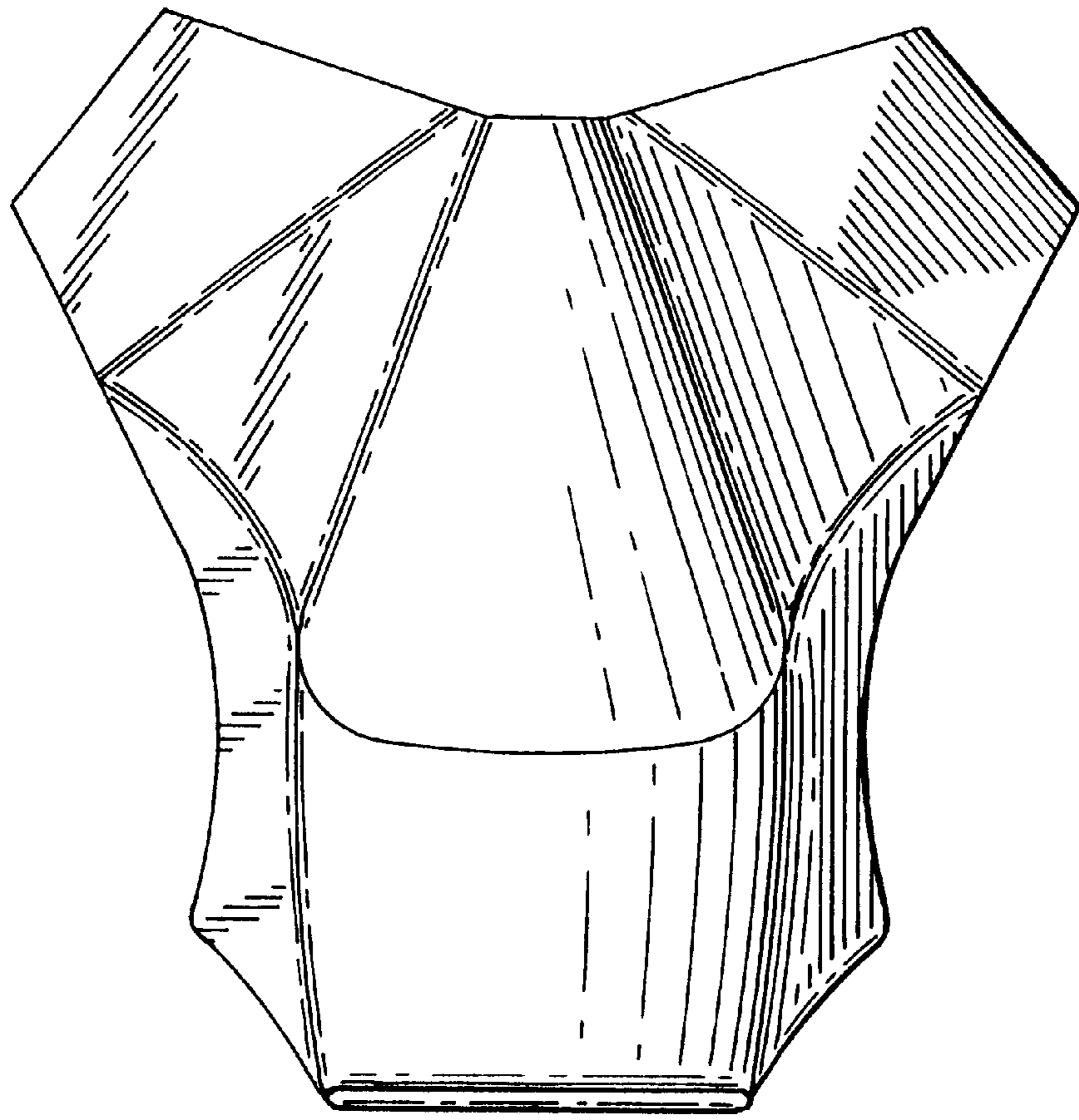
*FIG. 2*



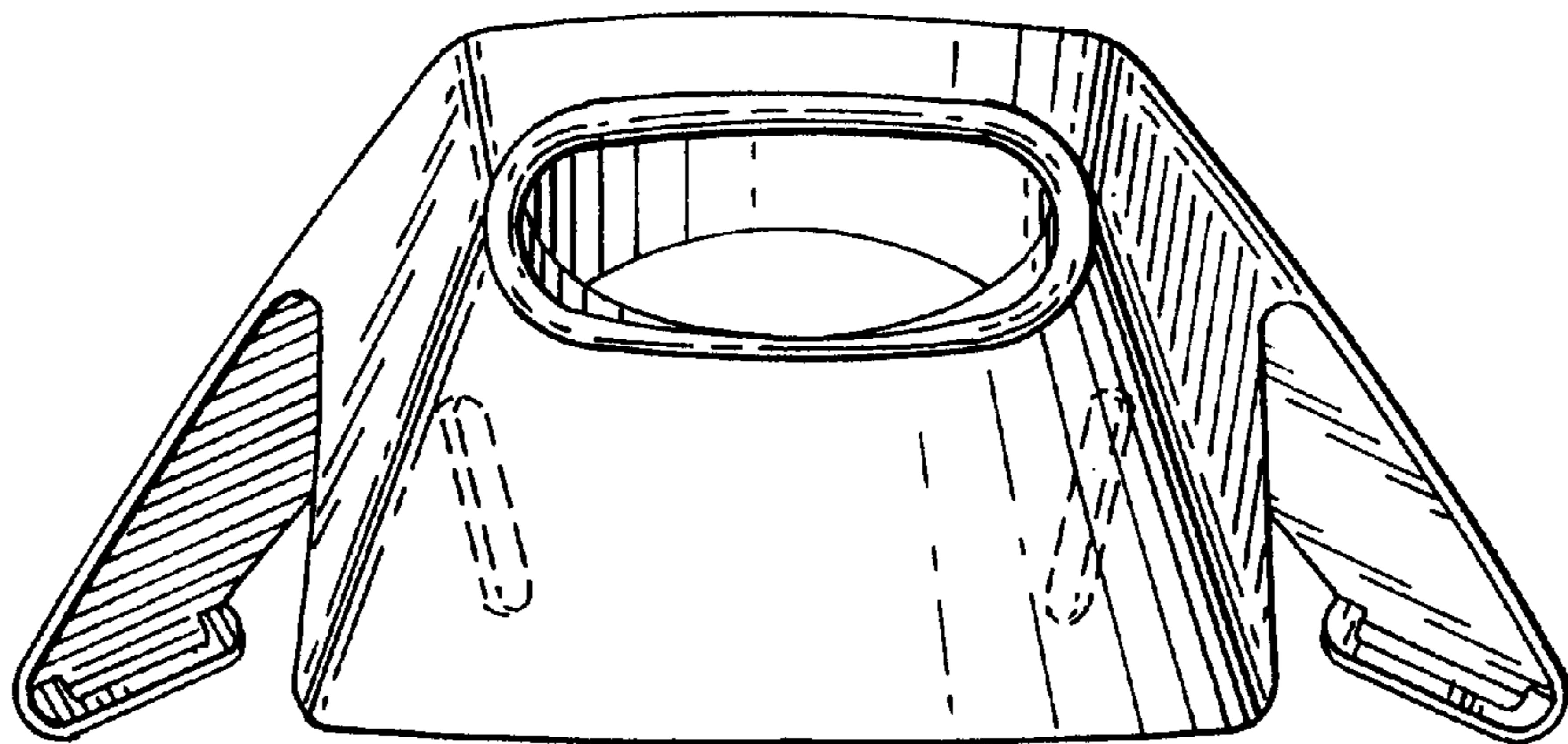
*FIG. 3*



*FIG. 4*



*FIG. 5*



*FIG. 6*