



US00D421283S

United States Patent [19]

[11] **Patent Number: Des. 421,283**

Briggs et al.

[45] **Date of Patent: ** Feb. 29, 2000**

[54] **OUTDOOR PLAY STRUCTURE HOUSING**

[75] Inventors: **Rick A. Briggs**, Springfield, Ill.; **Mark Weston**; **Denise Weston**, both of North Attleboro, Mass.; **Brendan Cuddihee**, Eureka, Mo.

[73] Assignee: **SCS Interactive, Inc.**, Springfield, Ill.

[**] Term: **14 Years**

[21] Appl. No.: **29/085,590**

[22] Filed: **Mar. 26, 1998**

[51] **LOC (6) Cl. 21-03**

[52] **U.S. Cl. D21/811; D21/511**

[58] **Field of Search D21/811, 814, D21/823-827, 831, 836, 837, 505, 506, 507, 511; 482/35, 36**

[56] **References Cited**

U.S. PATENT DOCUMENTS

- D. 250,784 1/1979 Dieter et al. .
- D. 251,262 3/1979 Barrett et al. .
- D. 340,273 10/1993 Ezell .
- D. 357,299 4/1995 Laing et al. .
- D. 358,190 5/1995 Strawcutter et al. .
- D. 366,086 1/1996 Ziegler, Jr. et al. D21/826
- D. 374,901 10/1996 Cacciola et al. D21/511
- D. 382,618 8/1997 Gift D21/814
- D. 385,941 11/1997 Carpenter D21/511
- D. 389,892 1/1998 Van Wagenen D21/827
- D. 397,188 8/1998 Bro et al. D21/814
- 4,251,069 2/1981 Beller .
- 4,262,900 4/1981 Vinson .
- 5,194,048 3/1993 Briggs .
- 5,480,336 1/1996 Blanchard .
- 5,554,074 9/1996 Von Parrish .
- 5,580,316 12/1996 Hill et al. .

OTHER PUBLICATIONS

Picture of Sandman Playground Equipment, The Christiana.
 Picture of Gym-Dandy, The Trusted One, Return of the Jedi,
 Scout Walker, Command Tower, Swing Set with Speeder
 Bike Rider No. 59340.
 Braunfelsbilt Products Brochure, Jan. 1994.

Soft Play Catalog, Our Innovations Are In Play Around The World.

Pamphlet entitled SCS Interactive Family Adventures . . . Discovery Treehouse.

Pamphlet entitled SCS Interactive Presents . . . The Interactive Water Funhouse.

Pamphlet entitled SCS Interactive Presents . . . The Interactive Waterplay Arena.

Specialty Products and Replacement Parts Catalog, Nov. 19, 1994.

Pentes Play, Inc., Soft Modular Play Systems, Sampler Catalog.

Pamphlet entitled Innovative Foam Technology, Inc.

Pamphlet entitled The Foam Factory.

Primary Examiner—Mitchell Siegel

Attorney, Agent, or Firm—Knobbe, Martens, Olson & Bear LLP

[57] **CLAIM**

The ornamental design for an outdoor play structure housing, as shown and described herein.

DESCRIPTION

FIG. 1 is a perspective view of an outdoor play structure housing having features in accordance with the present invention, the stylized "Popeye's Spinach Factory" logo above the main play-participant entrance-way being shown in phantom for illustrative purposes only and forms no part of the claimed design;

FIG. 2 is a top plan view of the outdoor play structure housing of FIG. 1;

FIG. 3 is a bottom plan view of the outdoor play structure housing of FIG. 1 ;

FIG. 4 is a front elevational view of the outdoor play structure housing of FIG. 2, the stylized "Popeye's Spinach Factory" logo above the main play-participant entrance-way being shown in phantom for illustrative purposes only and forms no part of the claimed design;

FIG. 5 is a rear elevational view of the outdoor play structure housing of FIG. 2;

FIG. 6 is a right side elevational view of the outdoor play structure housing of FIG. 2;

FIG. 7 is a left side elevational view of the outdoor play structure housing of FIG. 2;

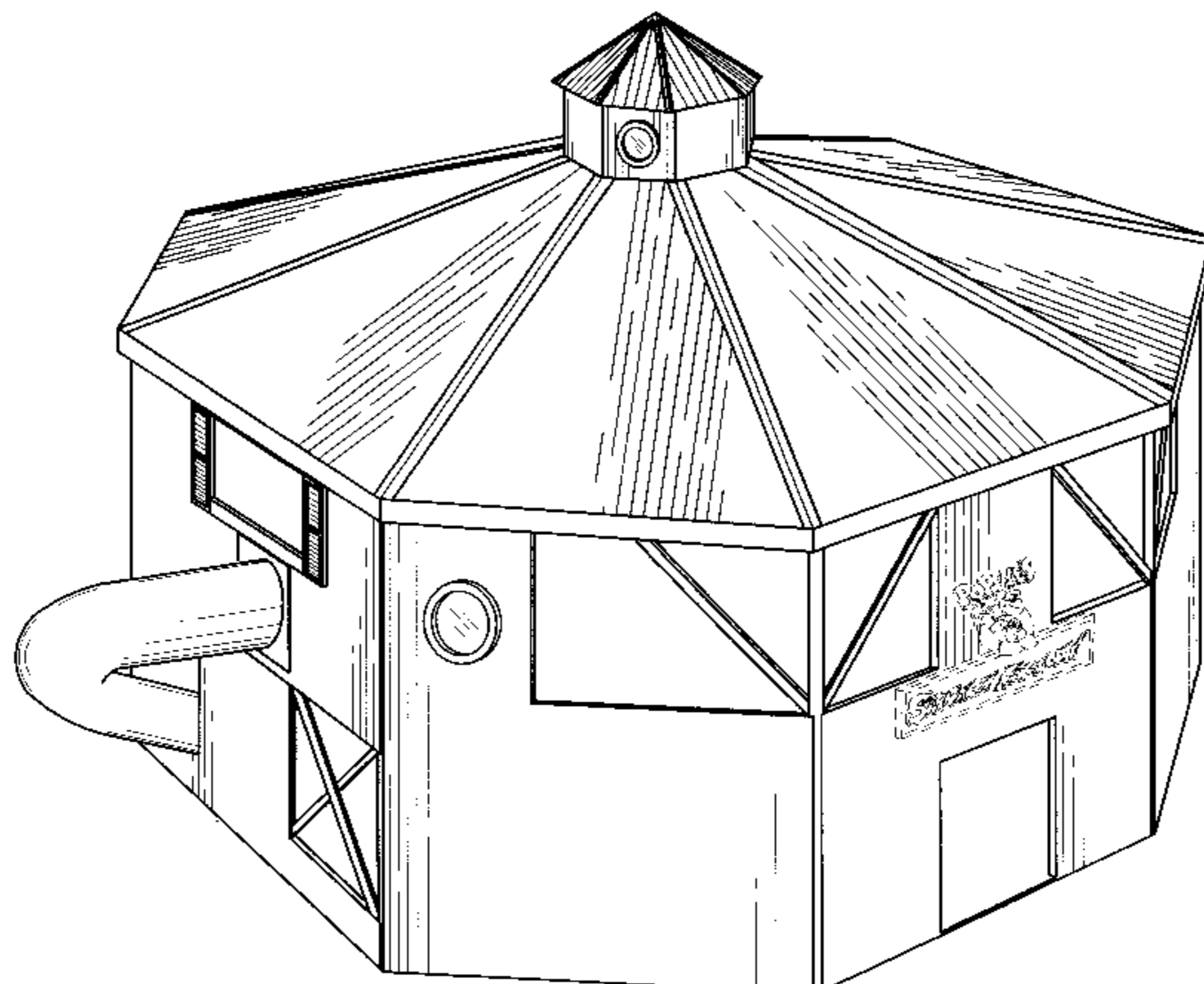

FIG. 8 is a front-right corner elevational view of the outdoor play structure housing of FIG. 2, the stylized “Popeye’s Spinach Factory” logo above the main play-participant entrance-way being shown in phantom for illustrative purposes only and forms no part of the claimed design;

FIG. 9 is a rear-left corner elevational view of the outdoor play structure housing of FIG. 2, the stylized “Popeye’s Spinach Factory” logo above the main play-participant entrance-way being shown in phantom for illustrative purposes only and forms no part of the claimed design;

FIG. 10 is a front-left corner elevational view of the outdoor play structure housing of FIG. 2; and,

FIG. 11 is a rear-right corner elevational view of the outdoor play structure housing of FIG. 2.

1 Claim, 6 Drawing Sheets

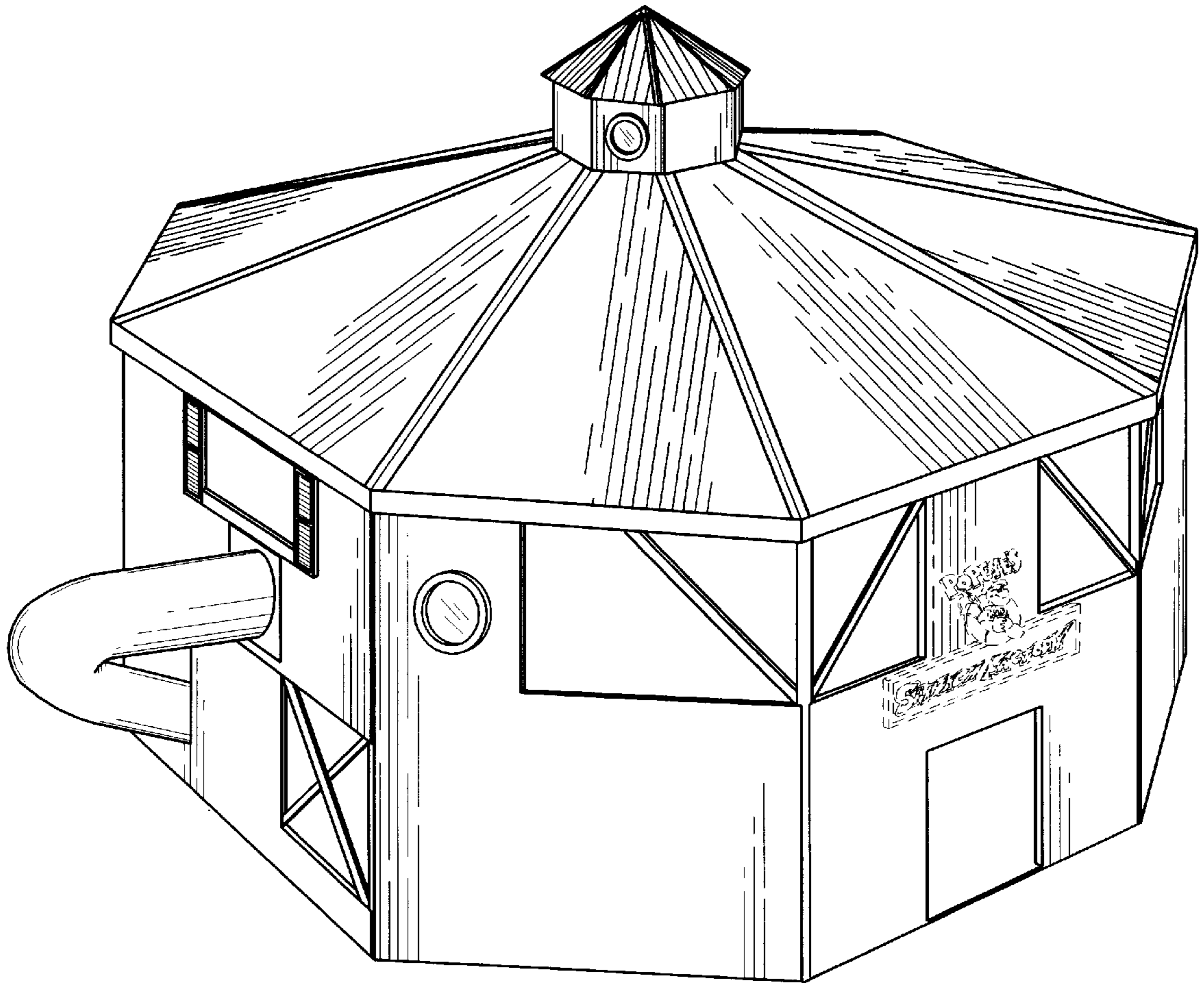

FIG. 1

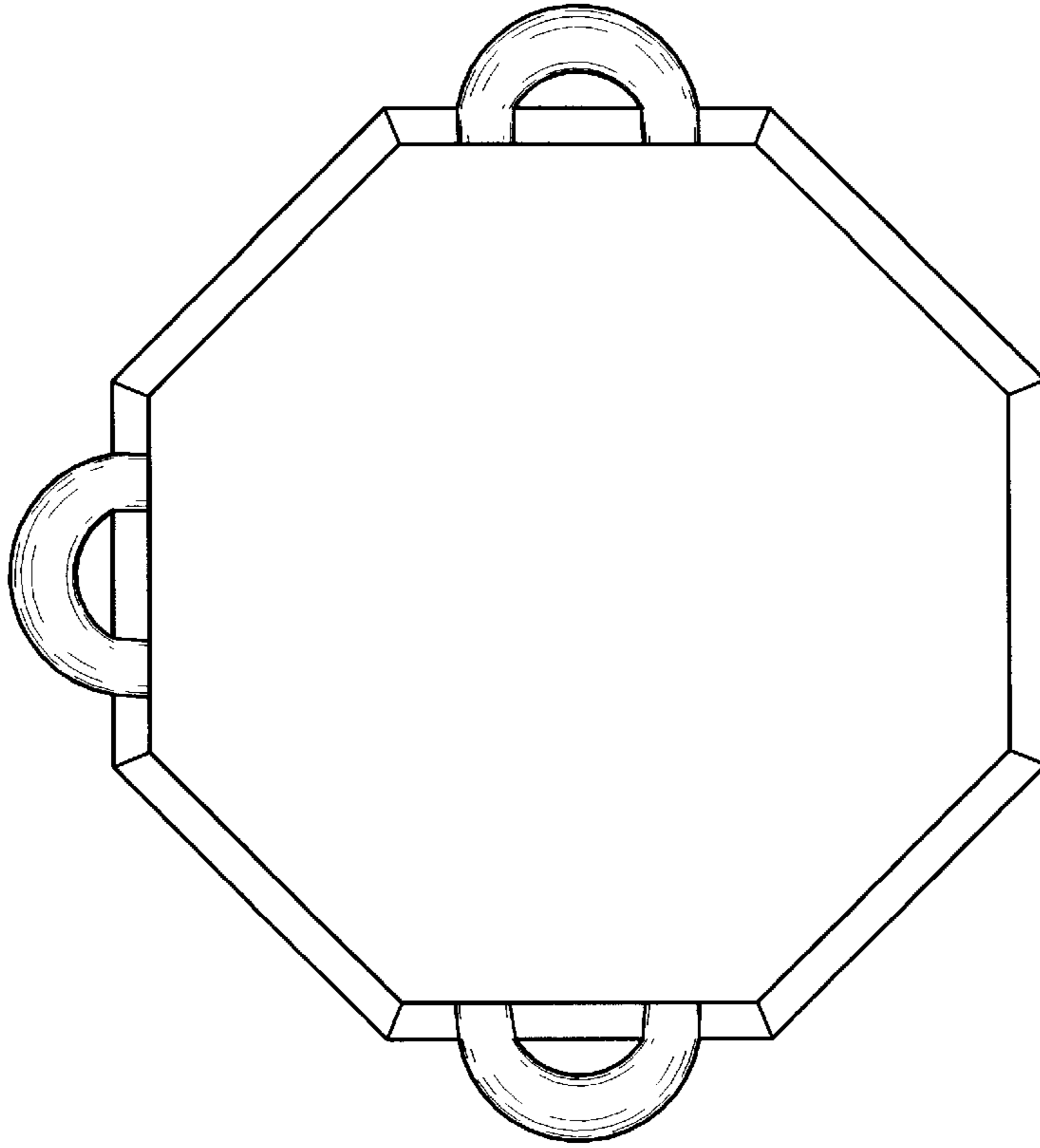

FIG. 3

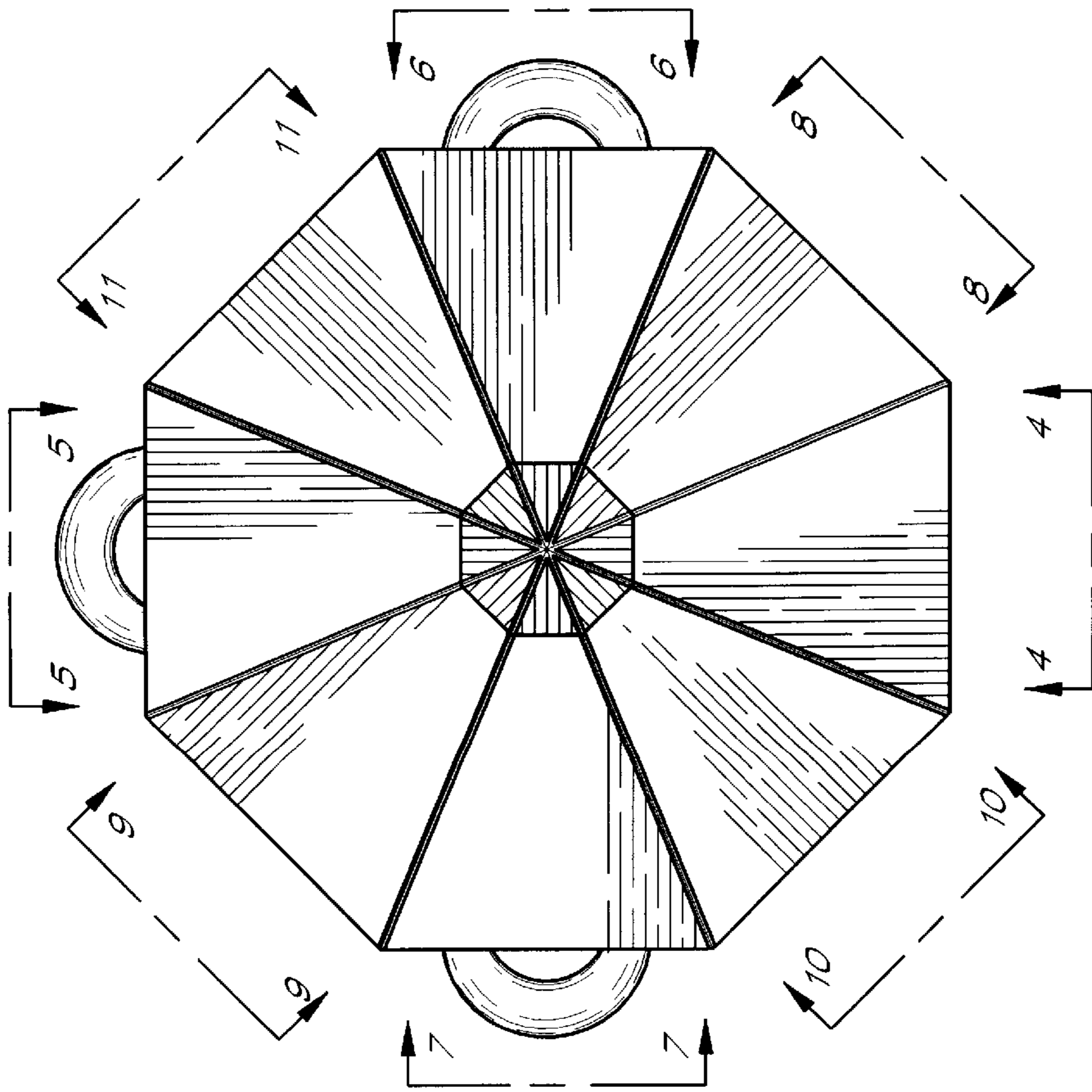

FIG. 2

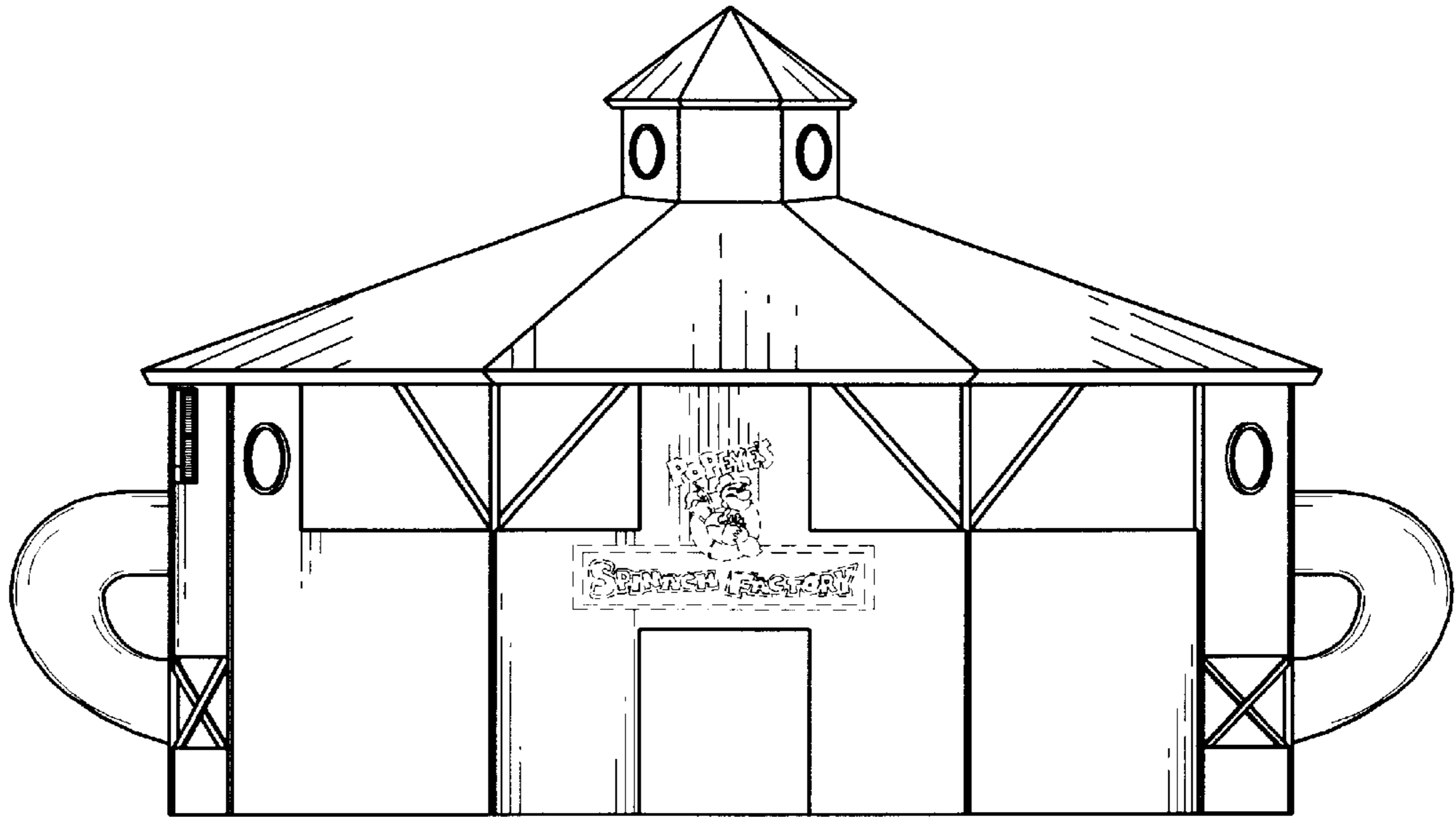

FIG. 4

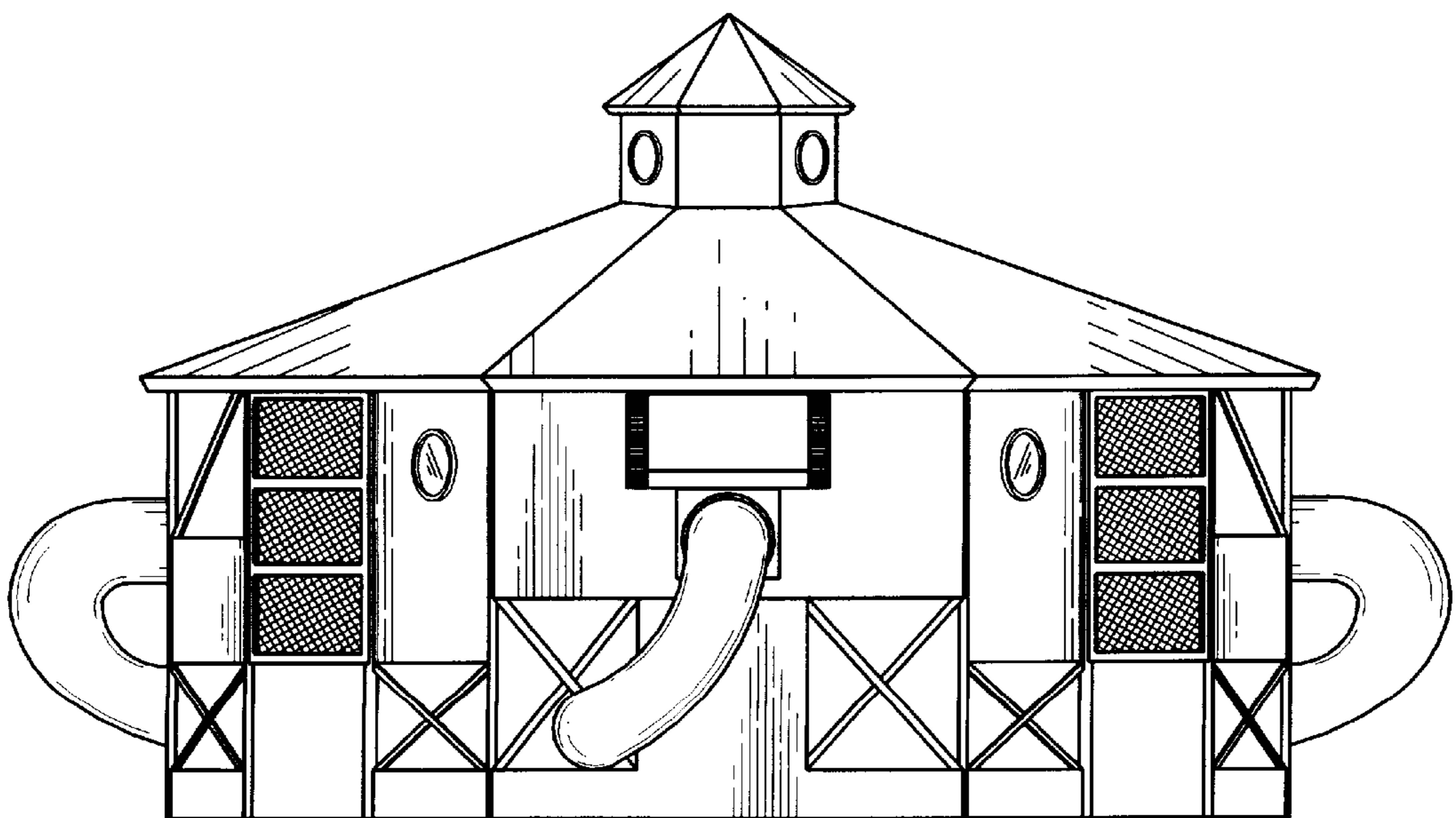

FIG. 5

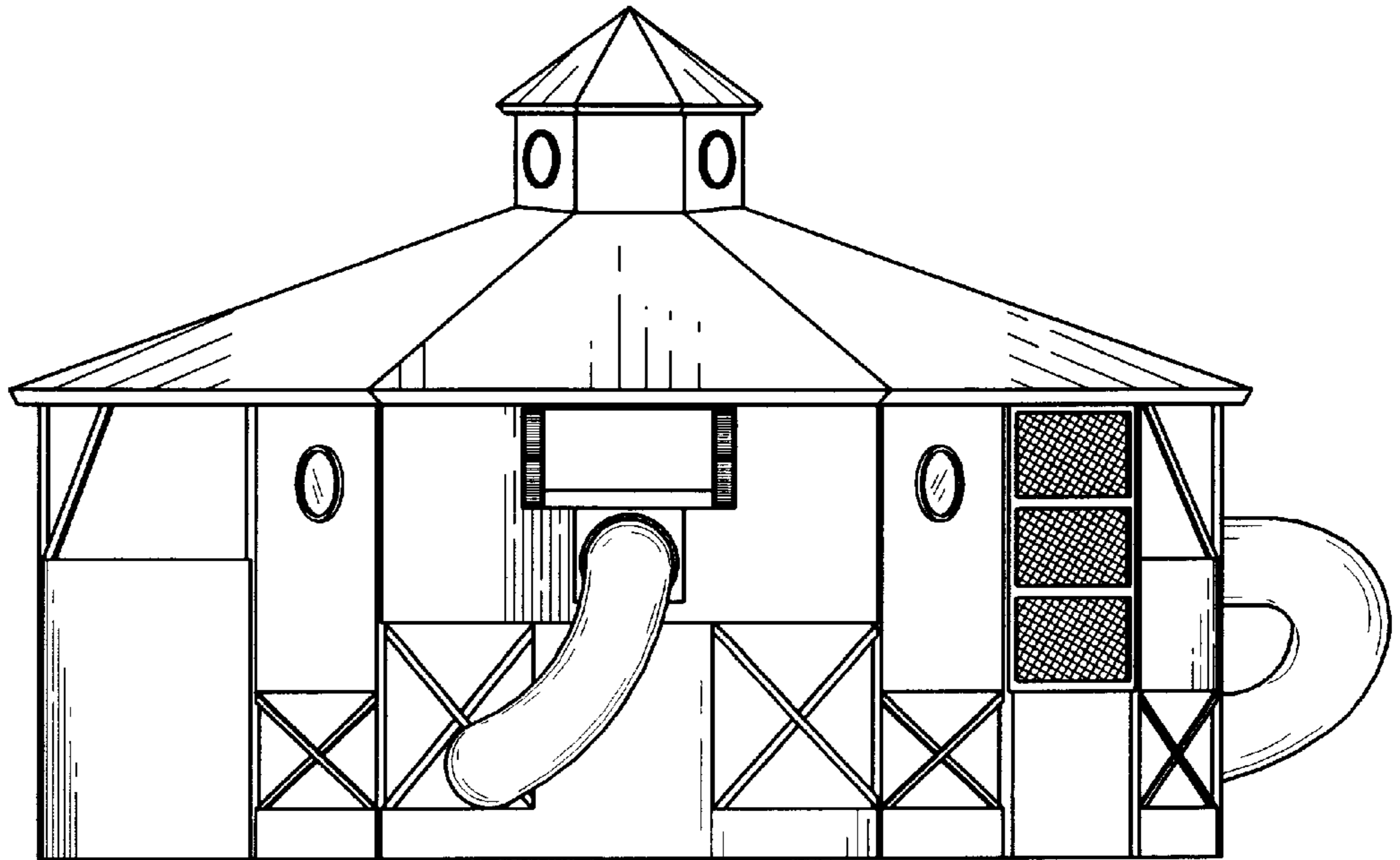

FIG. 6

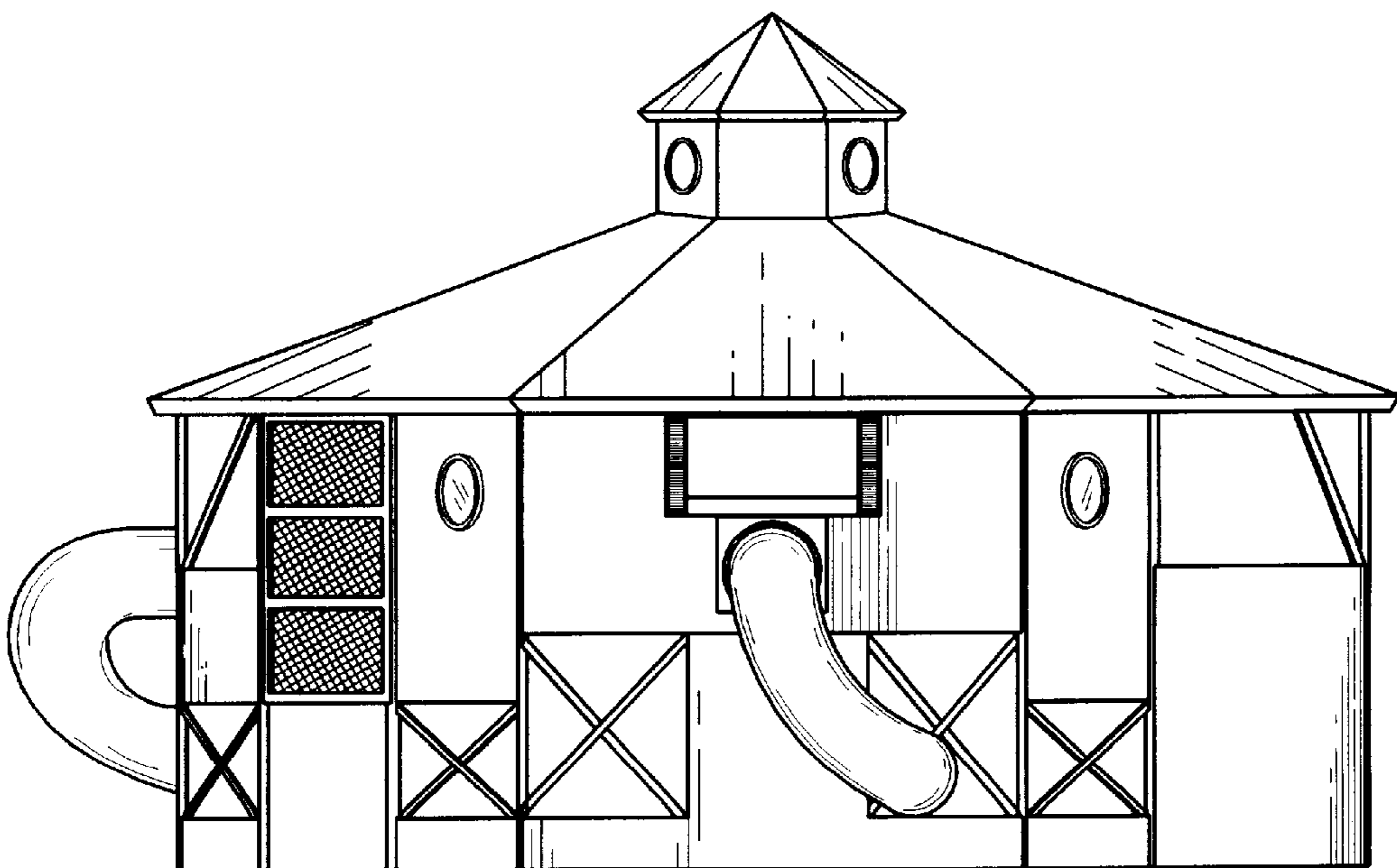

FIG. 7

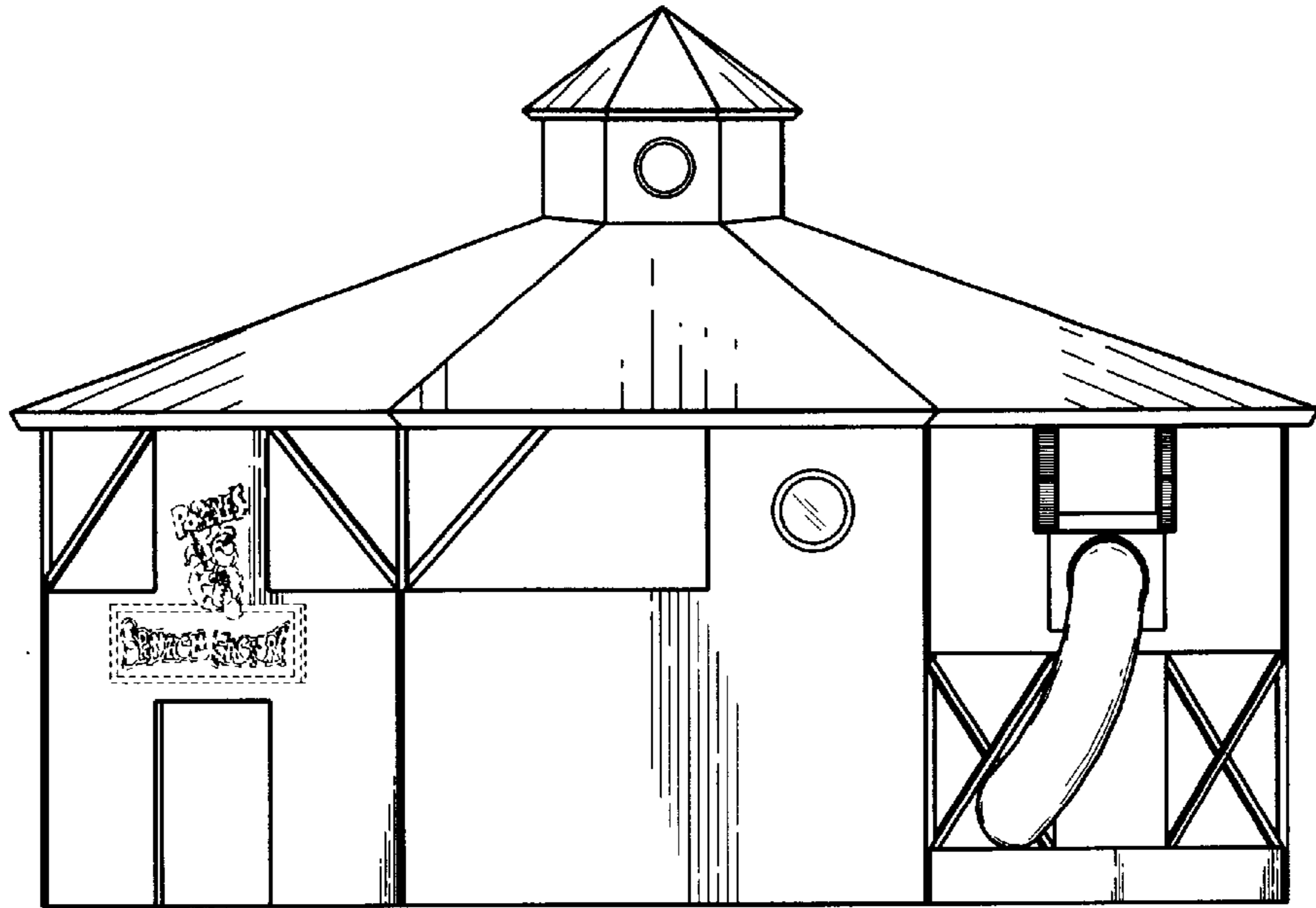

FIG. 8

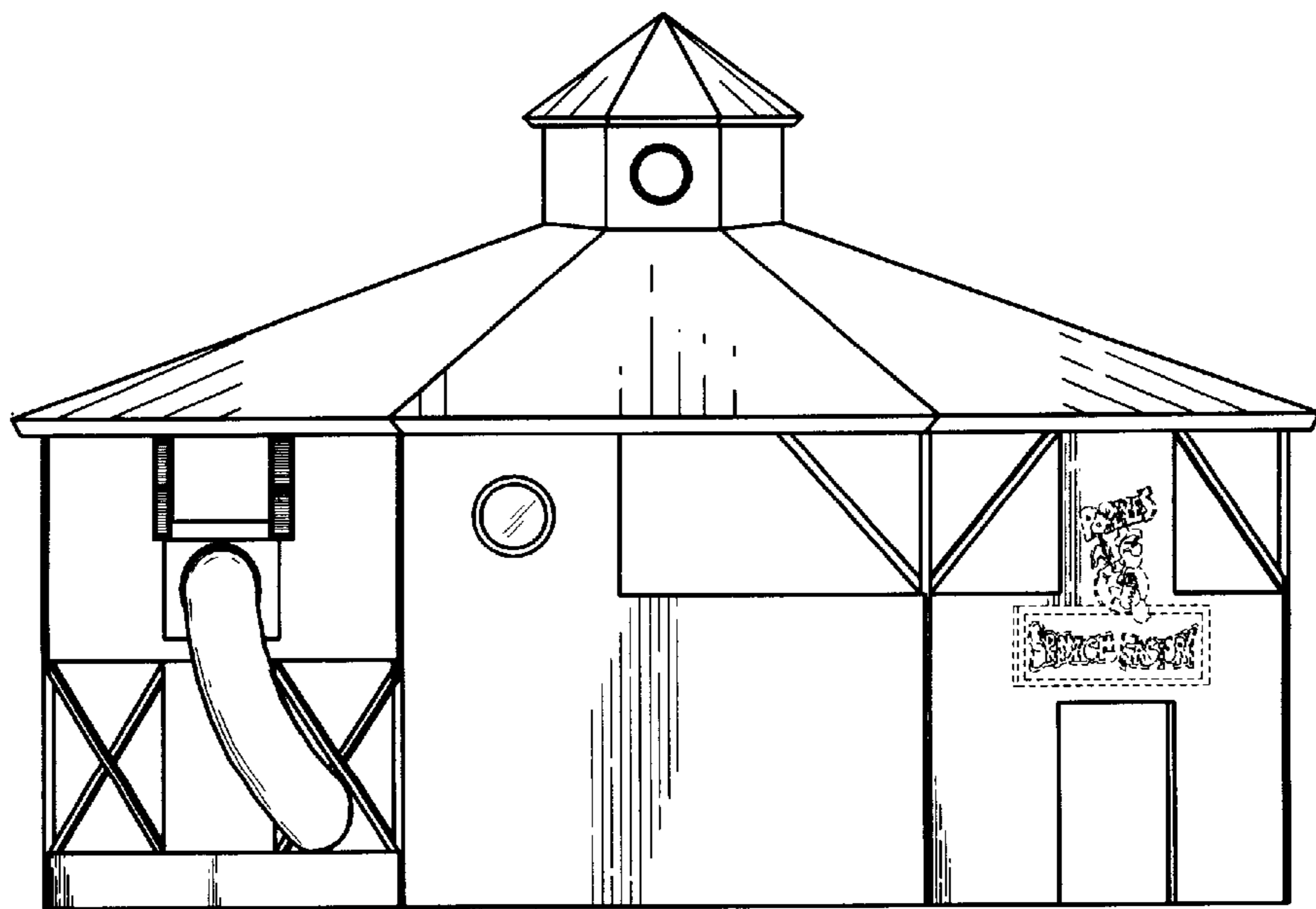

FIG. 9

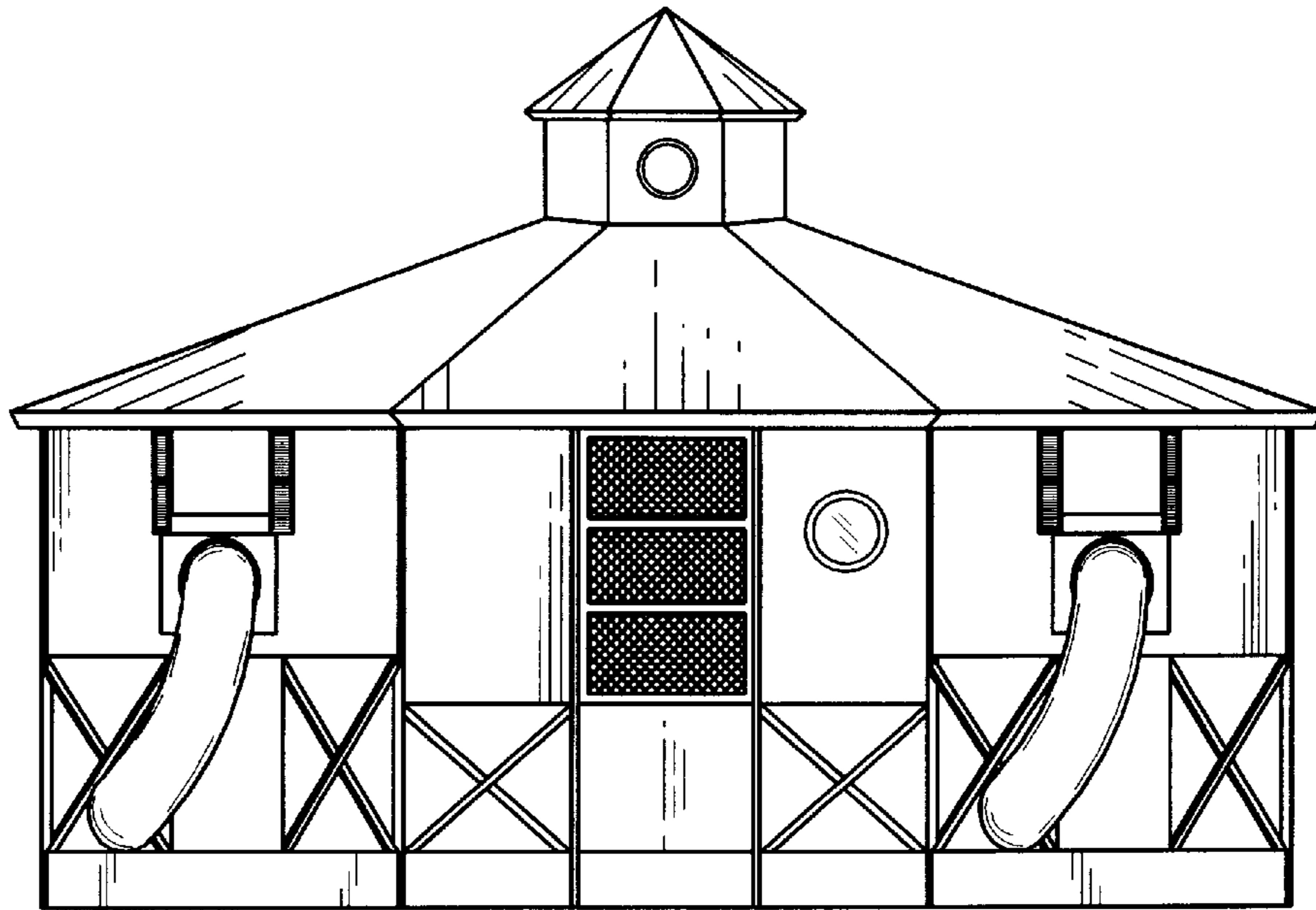

FIG. 10

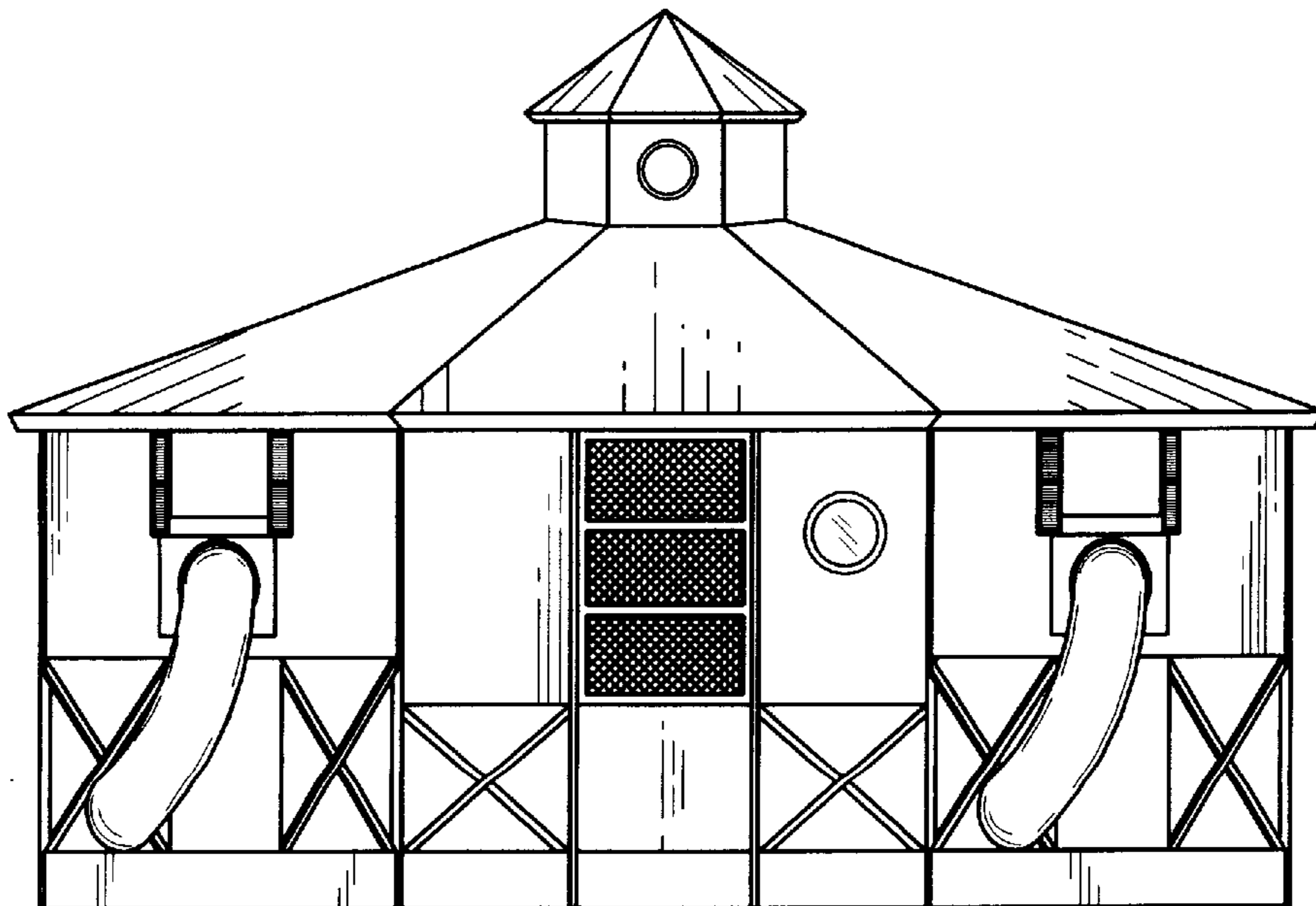

FIG. 11