



US00D421248S

# United States Patent [19] Baccei

[11] **Patent Number: Des. 421,248**

[45] **Date of Patent: \*\* Feb. 29, 2000**

[54] **FUSE CLIP**

4,176,906 12/1979 Urani ..... 439/830  
4,472,018 9/1984 Urani ..... 439/814

[75] Inventor: **James S. C. Baccei**, Terryville, Conn.

*Primary Examiner*—Adir Aronovich  
*Attorney, Agent, or Firm*—Michael H. Wallach

[73] Assignee: **Litton Systems, Inc.**, Woodland Hills, Calif.

[\*\*] Term: **14 Years**

[57] **CLAIM**

The ornamental design for a fuse clip, as shown and described.

[21] Appl. No.: **29/084,660**

**DESCRIPTION**

[22] Filed: **Mar. 6, 1998**

[51] **LOC (6) Cl.** ..... **13-03**

[52] **U.S. Cl.** ..... **D13/178**

[58] **Field of Search** ..... D13/147, 178;  
439/830, 831, 832

FIG. 1 is a perspective view of the fuse clip;  
FIG. 2 is a side view of the fuse clip;  
FIG. 3 is a right end view of the fuse clip as viewed in FIG. 1;  
FIG. 4 is a top plan view of the fuse clip;  
FIG. 5 is a left end view of the fuse clip as viewed in FIG. 1; and,  
FIG. 6 is a bottom plan view of the fuse clip.

[56] **References Cited**

**U.S. PATENT DOCUMENTS**

2,096,580 10/1937 Frank et al. .... D13/178  
2,229,989 1/1941 Roby ..... 439/830

**1 Claim, 3 Drawing Sheets**

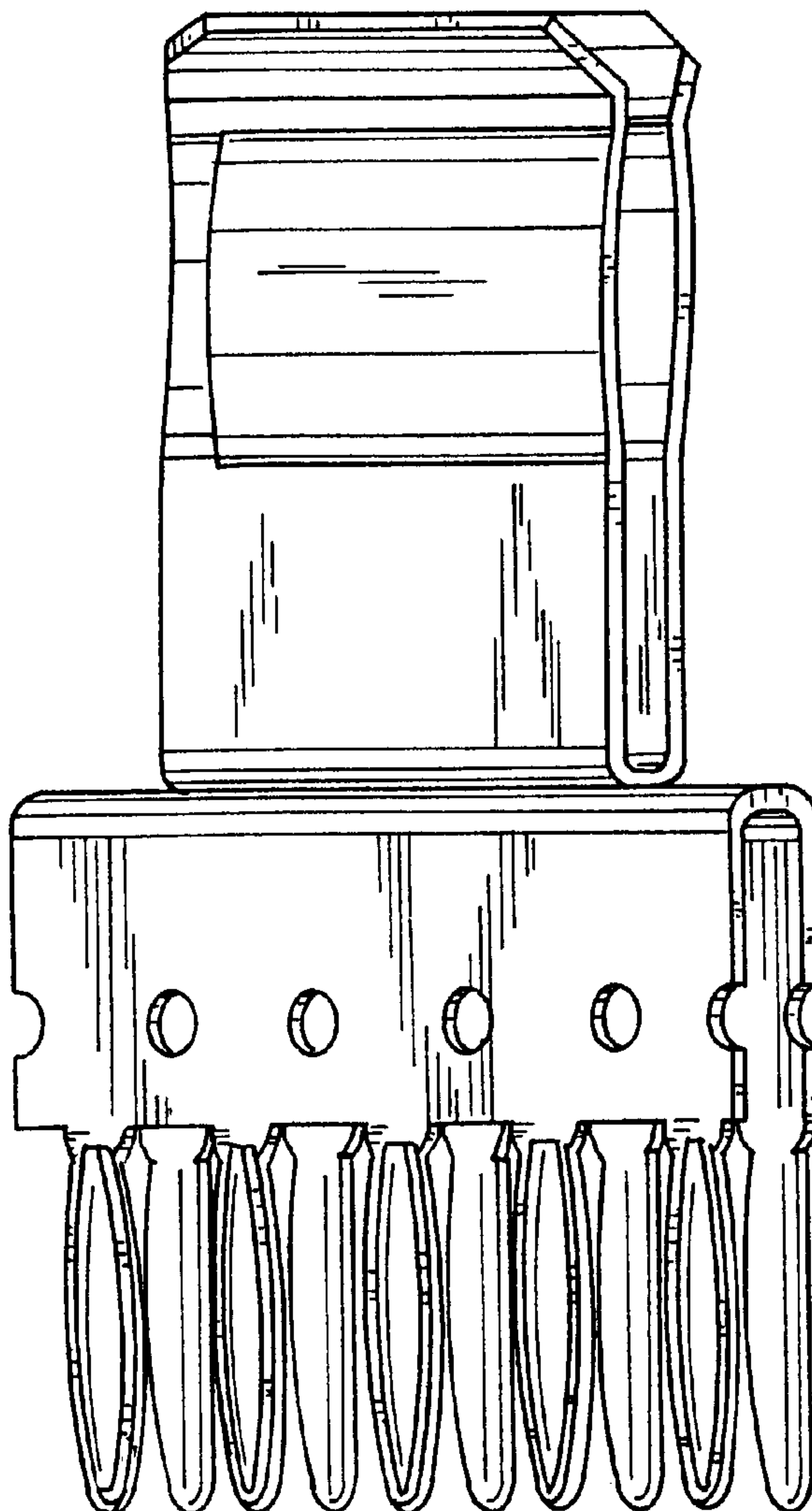

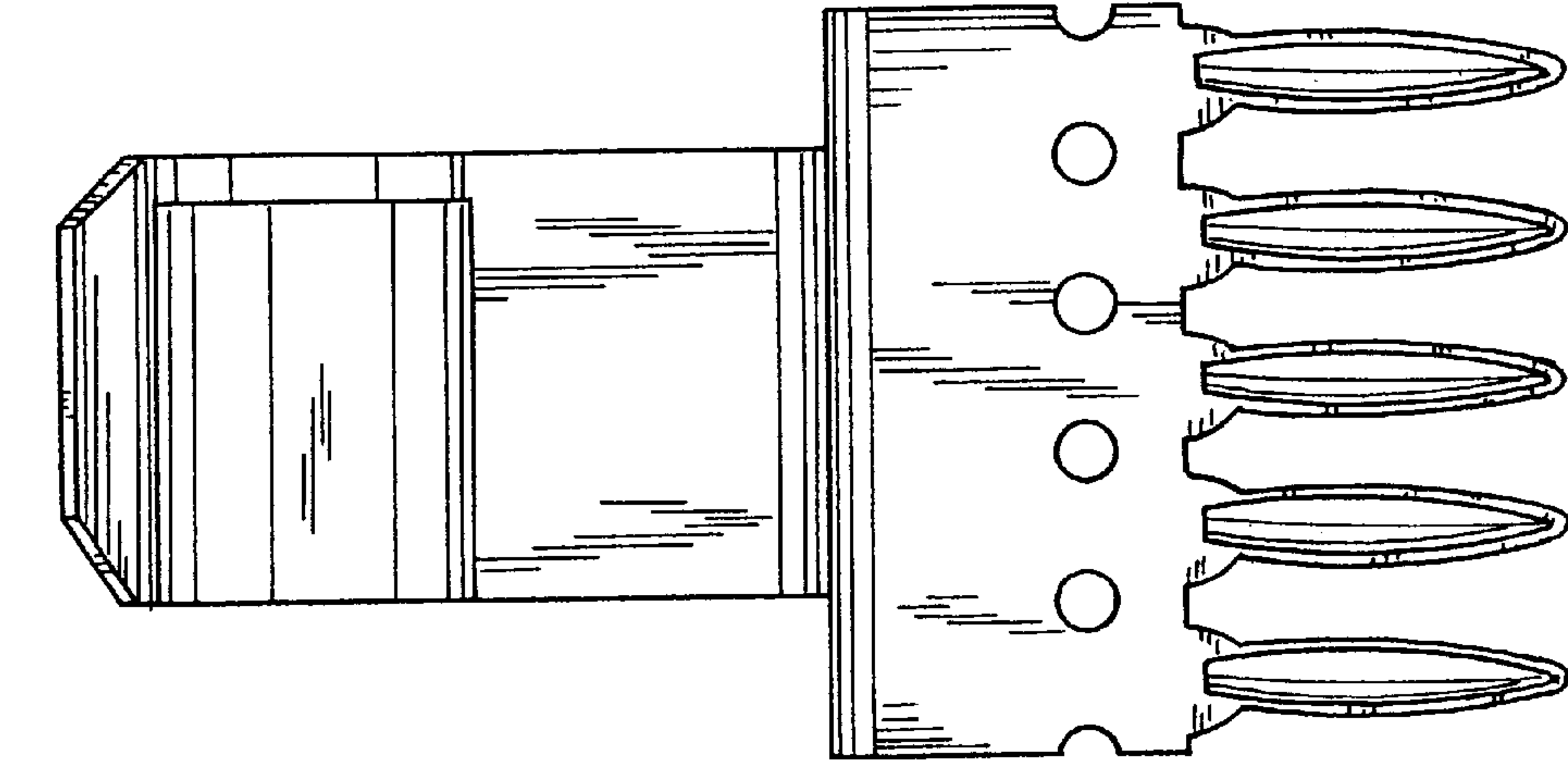

FIG. 2

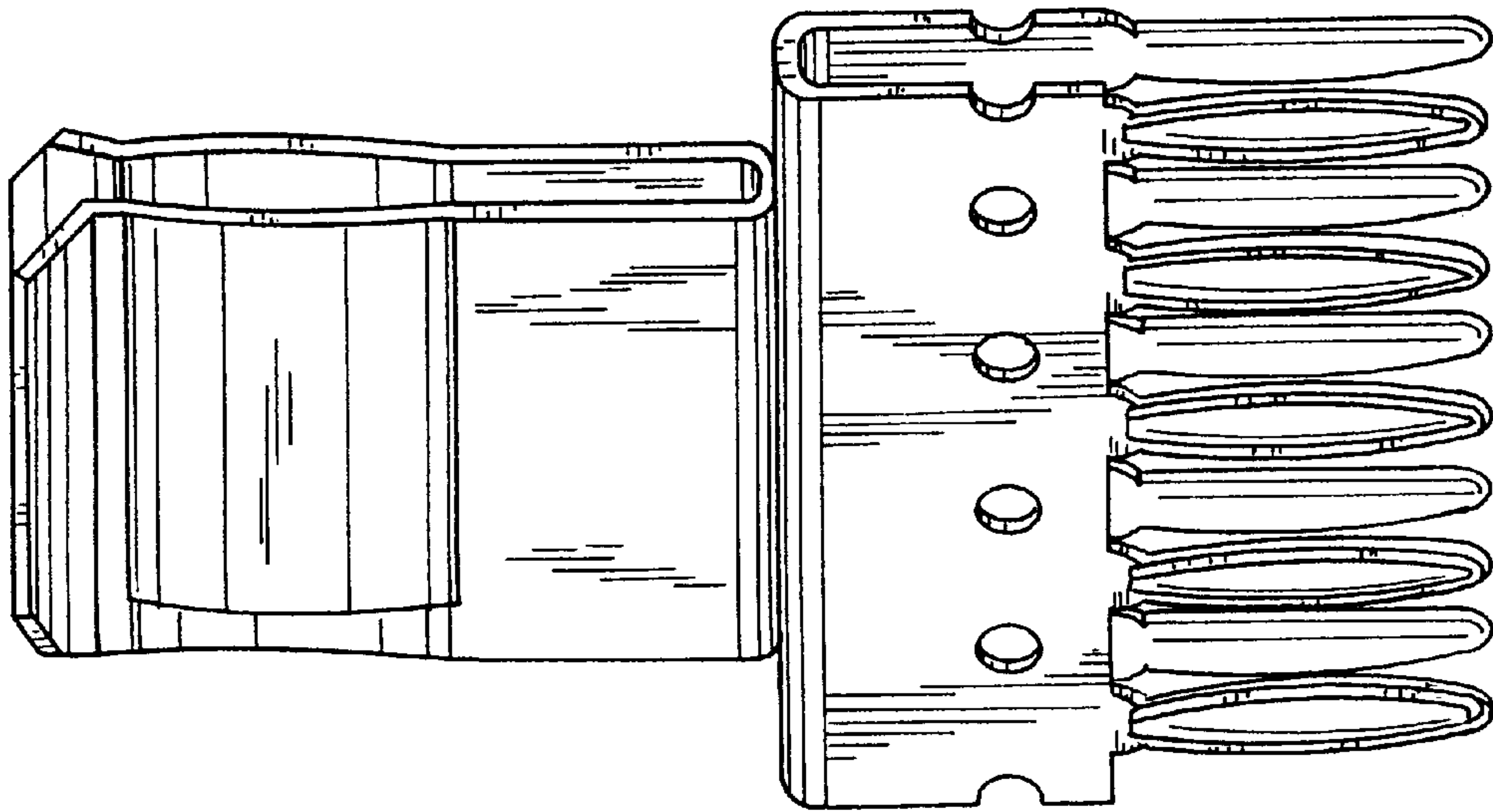

FIG. 1

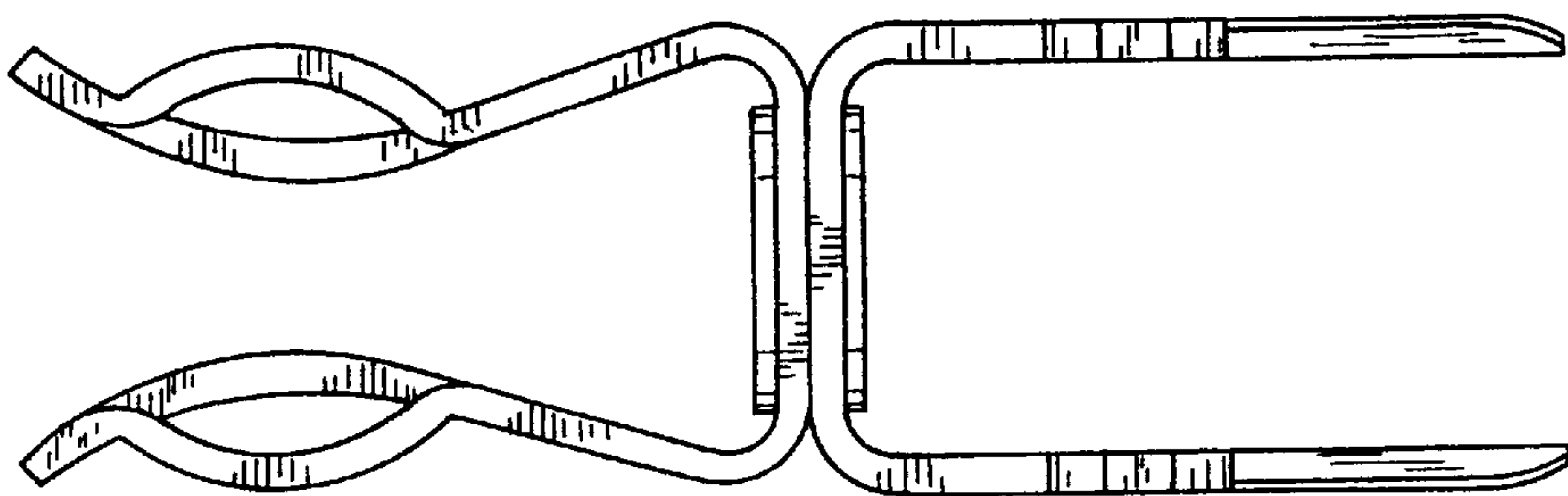

FIG. 3

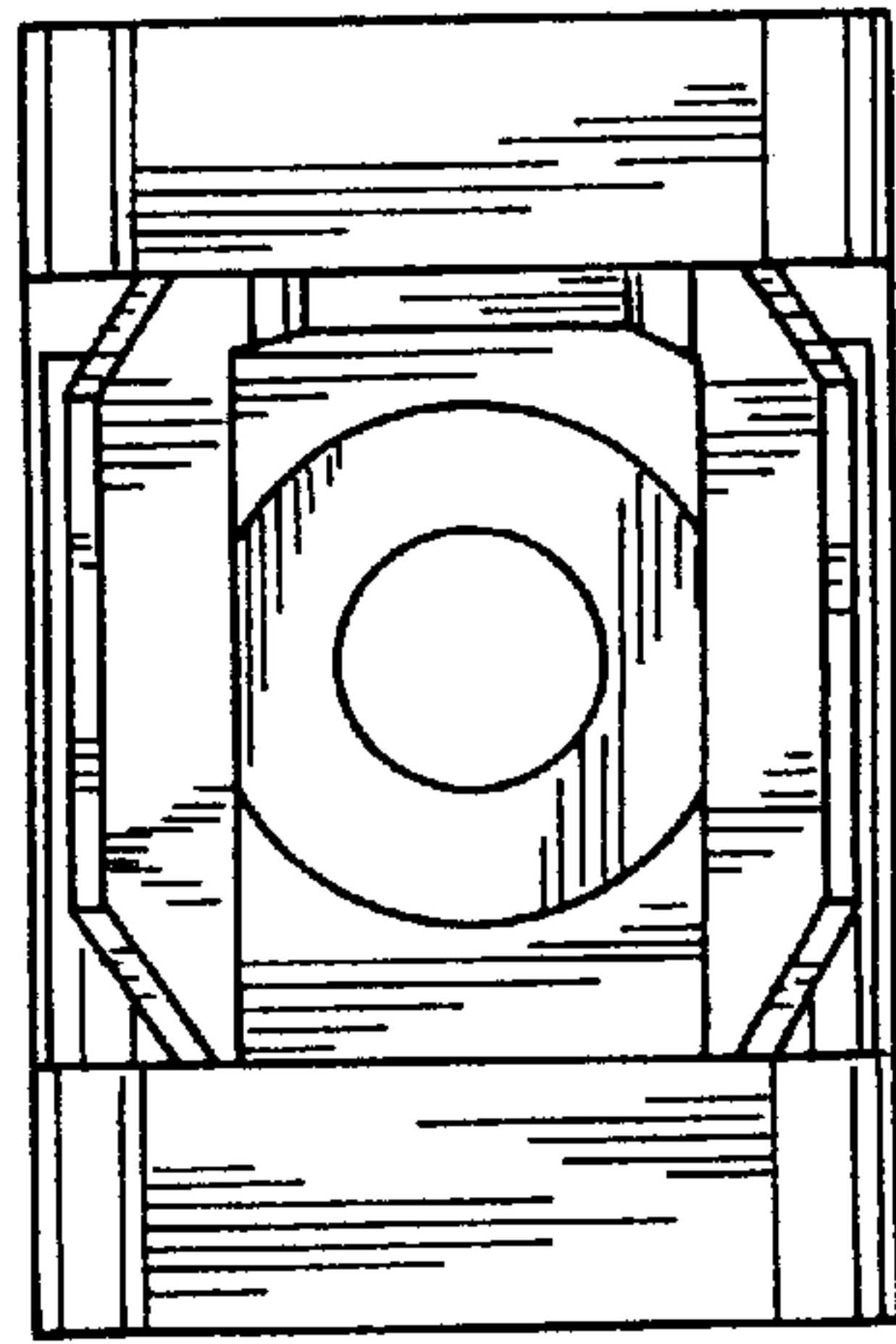

FIG. 4

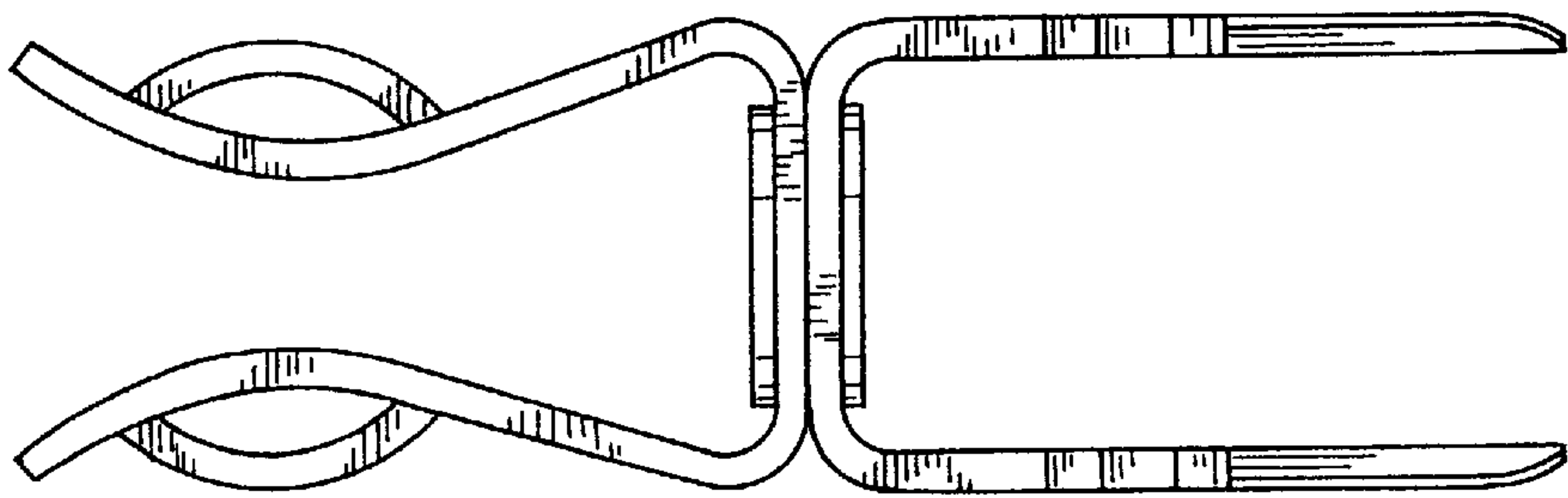

FIG. 5

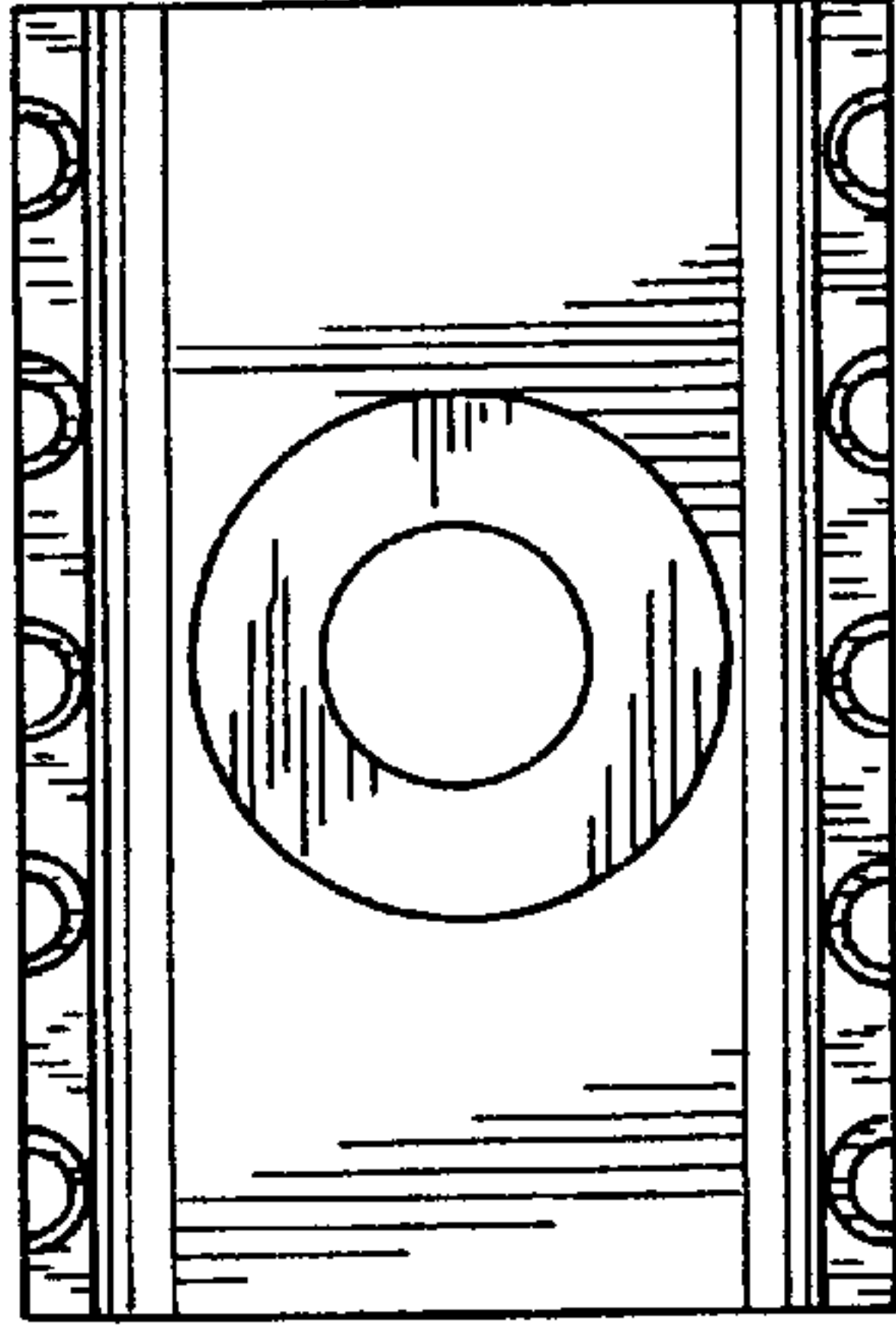

FIG. 6