



US00D421193S

United States Patent [19]

[11] Patent Number: Des. 421,193

Natuzzi et al.

[45] Date of Patent: ** Feb. 29, 2000

[54] SEAT

[75] Inventors: Pasquale Natuzzi, Bari; Arcangelo Scarati, Taranto, both of Italy

[73] Assignee: Industrie Natuzzi, SpA, Bari, Italy

[**] Term: 14 Years

[21] Appl. No.: 29/102,457

[22] Filed: Mar. 22, 1999

[51] LOC (6) Cl. 06-01

[52] U.S. Cl. D6/381; D6/334

[58] Field of Search D6/334, 335, 336, D6/364, 371, 373, 381, 500, 501, 502; 297/232, 445.1

[56] References Cited

U.S. PATENT DOCUMENTS

D. 382,722	8/1997	Natuzzi et al.	D6/381
D. 384,217	9/1997	Natuzzi et al.	D6/381
D. 385,426	10/1997	Gibson	D6/381
D. 387,575	12/1997	Natuzzi et al.	D6/381
D. 407,572	4/1999	Natuzzi et al.	D6/381
D. 407,573	4/1999	Natuzzi et al.	D6/381

OTHER PUBLICATIONS

Natuzzi Model 174, at least as early as 1987, at International Home Furnishings Market in High Point, North Carolina.

Natuzzi Model 199, Oct. 1987, at International Home Furnishings Market in High Point, North Carolina.

Natuzzi Model 426, at least as early as 1988, at International Home Furnishings Market in High Point, North Carolina.

Natuzzi Model 462, Oct. 1988, at International Home Furnishings Market in High Point, North Carolina.

Natuzzi Model 464, Oct. 1988, at International Home Furnishings Market in High Point, North Carolina.

Natuzzi Model 484, Apr. 1989, at International Home Furnishings Market in High Point, North Carolina.

Natuzzi Model 733, Nov. 1989, at International Home Furnishings Market in High Point, North Carolina.

Natuzzi Model 748, Apr. 1990, at International Home Furnishing Market in High Point, North Carolina.

Natuzzi Model 758, Apr. 1990, at International Home Furnishings Market in High Point, North Carolina.

Natuzzi Model 763, Apr. 1990, at International Home Furnishings Market in High Point, North Carolina.

Natuzzi Model 766, Apr. 1990, at International Home Furnishings Market in High Point, North Carolina.

Natuzzi Model 771, Oct. 1990, at International Home Furnishings Market in High Point, North Carolina.

Natuzzi Model 898, Apr. 1992, at International Home Furnishings Market in High Point, North Carolina.

Natuzzi Model 945, Oct. 1992, at International Home Furnishings Market in High Point, North Carolina.

Natuzzi Model 1077, Sep. 1993, at International Home Furnishings Market in High Point, North Carolina.

Natuzzi Model 1083, Sep. 1993, at International Home Furnishings Market in High Point, North Carolina.

Natuzzi Model 1098, Jan. 1994, at International Home Furnishings Market in High Point, North Carolina.

Natuzzi Model 1118, Jan. 1994, at International Home Furnishings Market in High Point, North Carolina.

Natuzzi Model 1123, Jan. 1994, at International Home Furnishings Market in High Point, North Carolina.

Natuzzi Model 1164, Apr. 1994, at International Home Furnishings Market in High Point, North Carolina.

Natuzzi Model 1207, Oct. 1994, at International Home Furnishings Market in High Point, North Carolina.

Natuzzi Model 1395, Mar. 1996, at International Home Furnishings Market in High Point, North Carolina.

Natuzzi Model 1571, Apr. 1997, at International Home Furnishings Market in High Point, North Carolina.

Natuzzi Model 1572, Apr. 1997, at International Home Furnishings Market in High Point, North Carolina.

Natuzzi Model 1603, Apr. 1997, at International Home Furnishings Market in High Point, North Carolina.

Natuzzi Model 1604, Apr. 1997, at International Home Furnishings Market in High Point, North Carolina.

Natuzzi Model 1645, Oct. 1997, at International Home Furnishings Market in High Point, North Carolina.

Primary Examiner—Gary D. Watson

Attorney, Agent, or Firm—Alston & Bird LLP

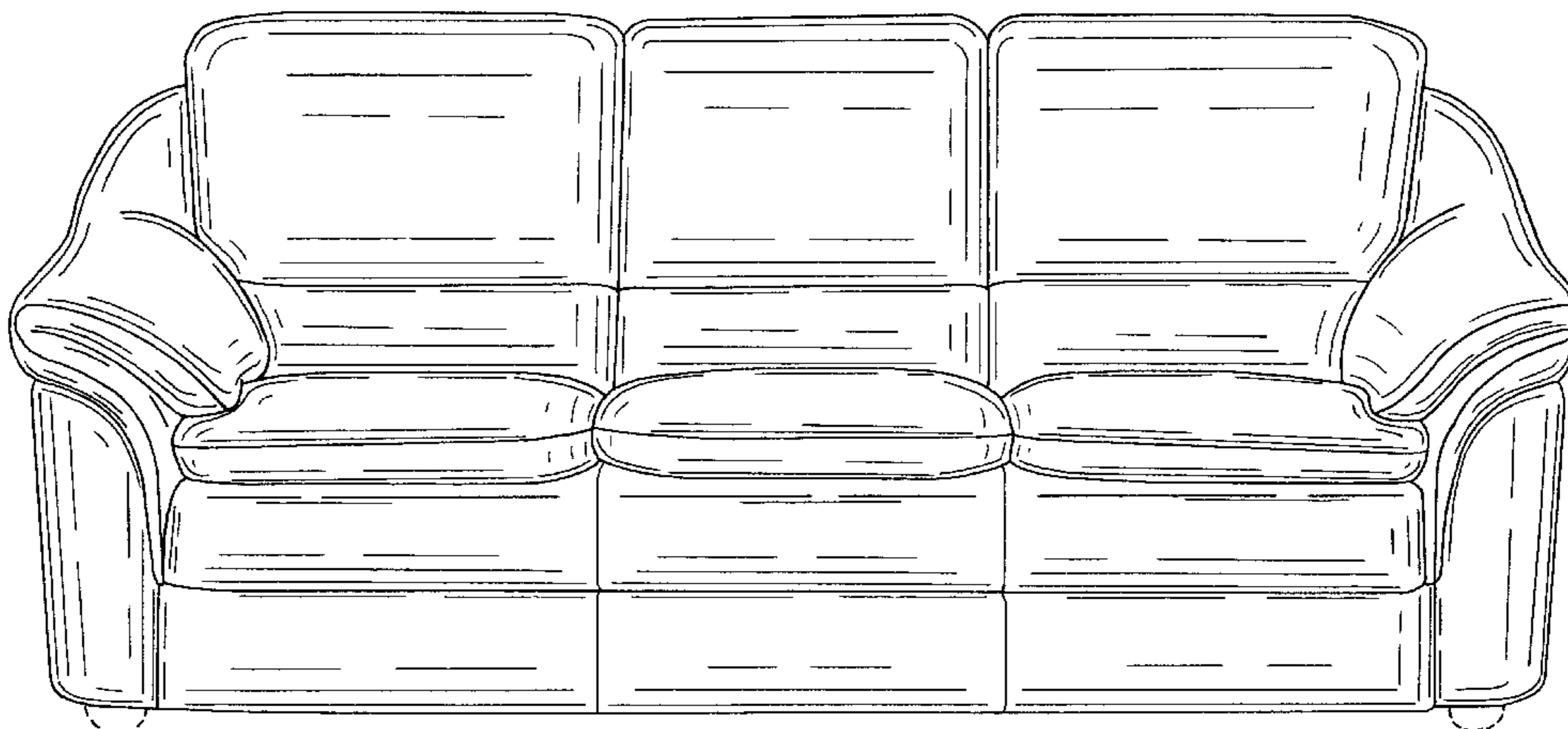

[57]

CLAIM

The ornamental design for a seat, as shown and described.

DESCRIPTION

FIG. 1 is a front perspective view of a seat showing a first embodiment of our new design in the form of a sofa;

FIG. 2 is a front elevational view thereof;

FIG. 3 is a top plan view thereof;

FIG. 4 is a right side elevational view, the left side being a mirror image thereof;

FIG. 5 is a rear perspective view thereof;

FIG. 6 is a front perspective view of a seat showing a second embodiment of our new design in the form of a love seat; and,

FIG. 7 is a front perspective view of a seat showing a third embodiment of our new design in the form of a chair.

The broken lines shown herein are for illustrative purposes only and form no part of the claimed design.

The rear views of FIGS. 6 and 7 are like FIG. 5, the difference being a matter of length.

The end views of FIGS. 6 and 7 are like FIG. 4.

FIGS. 2 through 4, 6 and 7 have been shown on a reduced scale with respect to FIG. 1.

FIG. 5 has been shown on a further reduced scale.

1 Claim, 3 Drawing Sheets

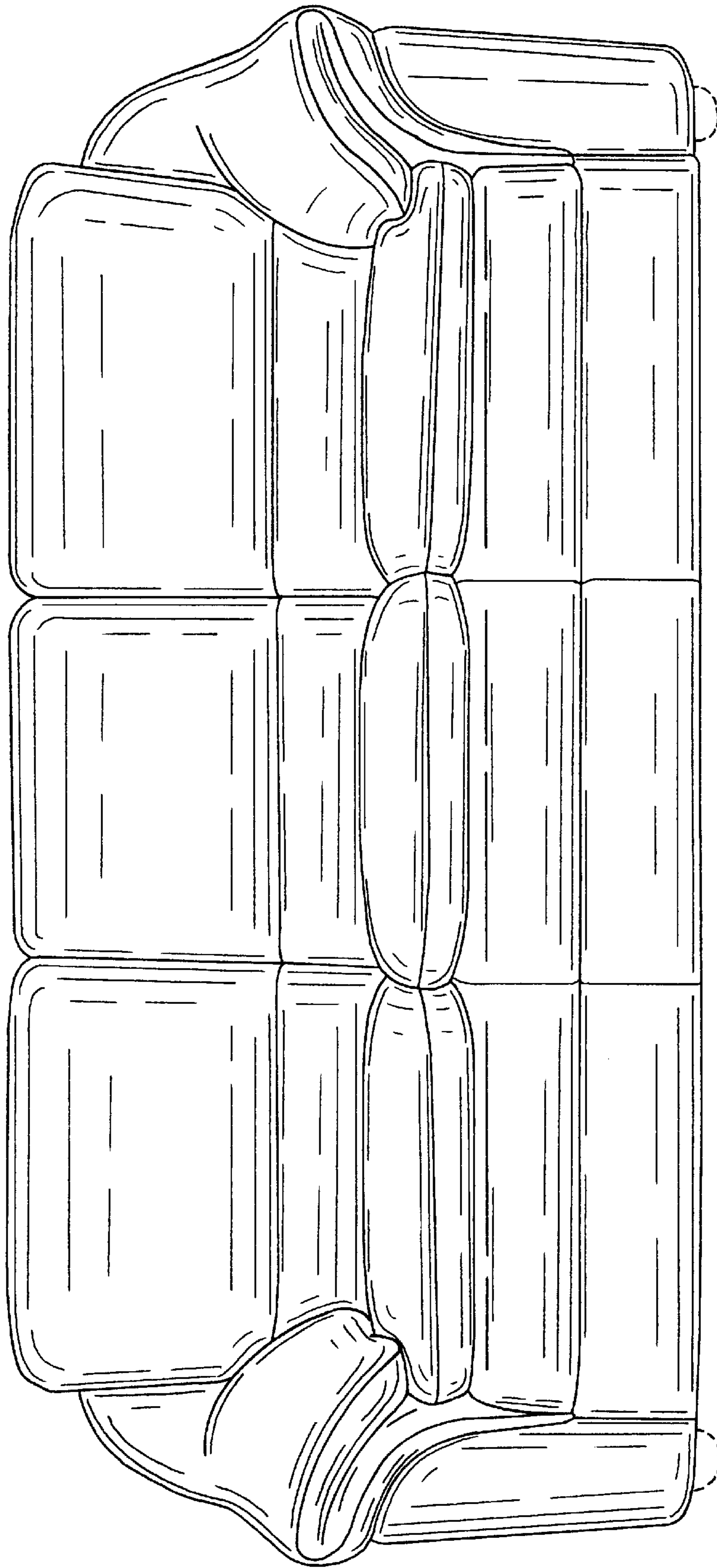

FIG. 1.

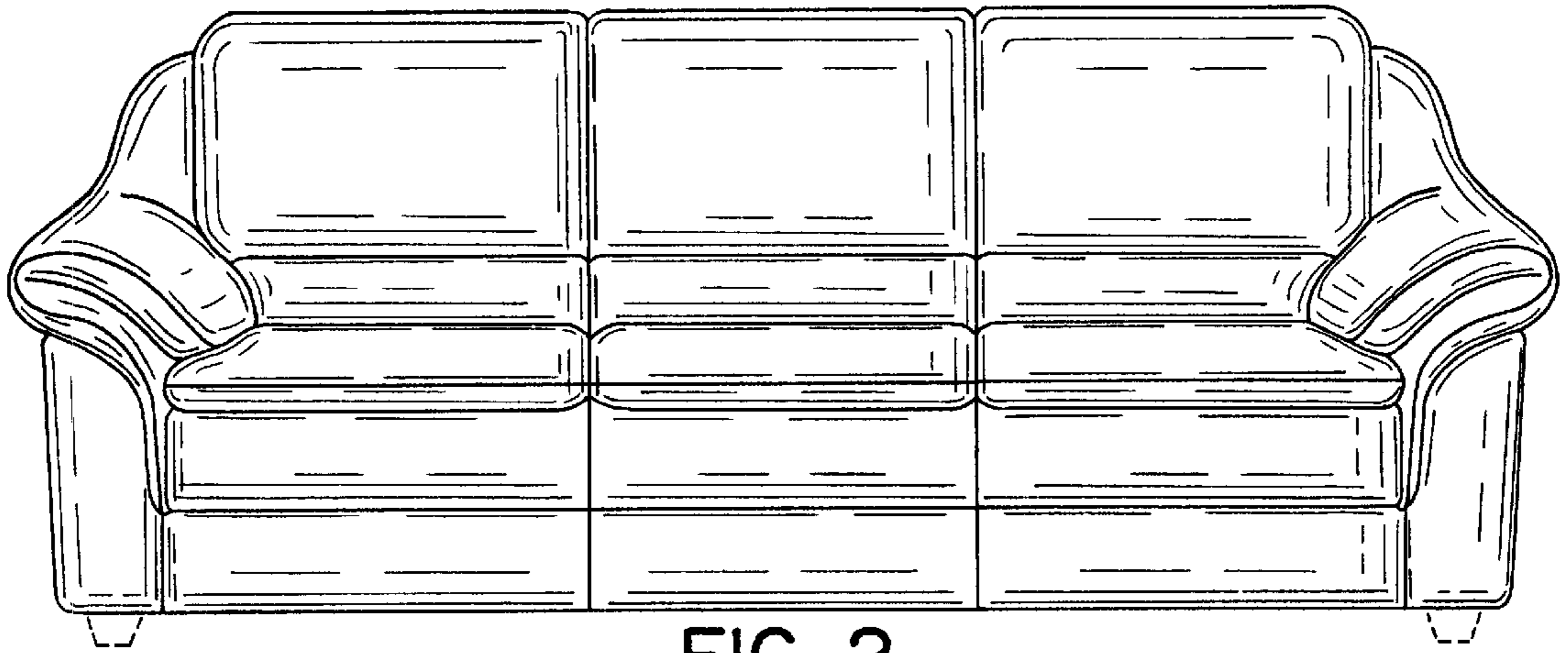

FIG. 2.

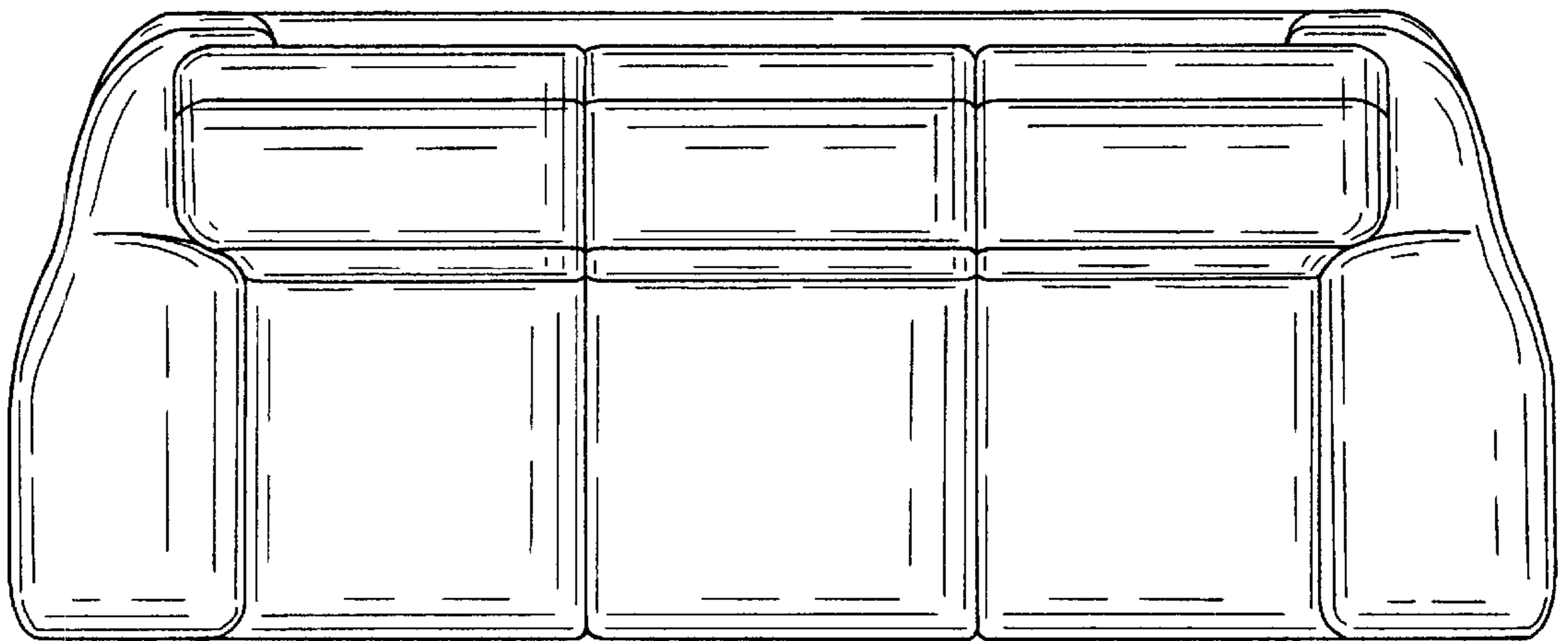

FIG. 3.

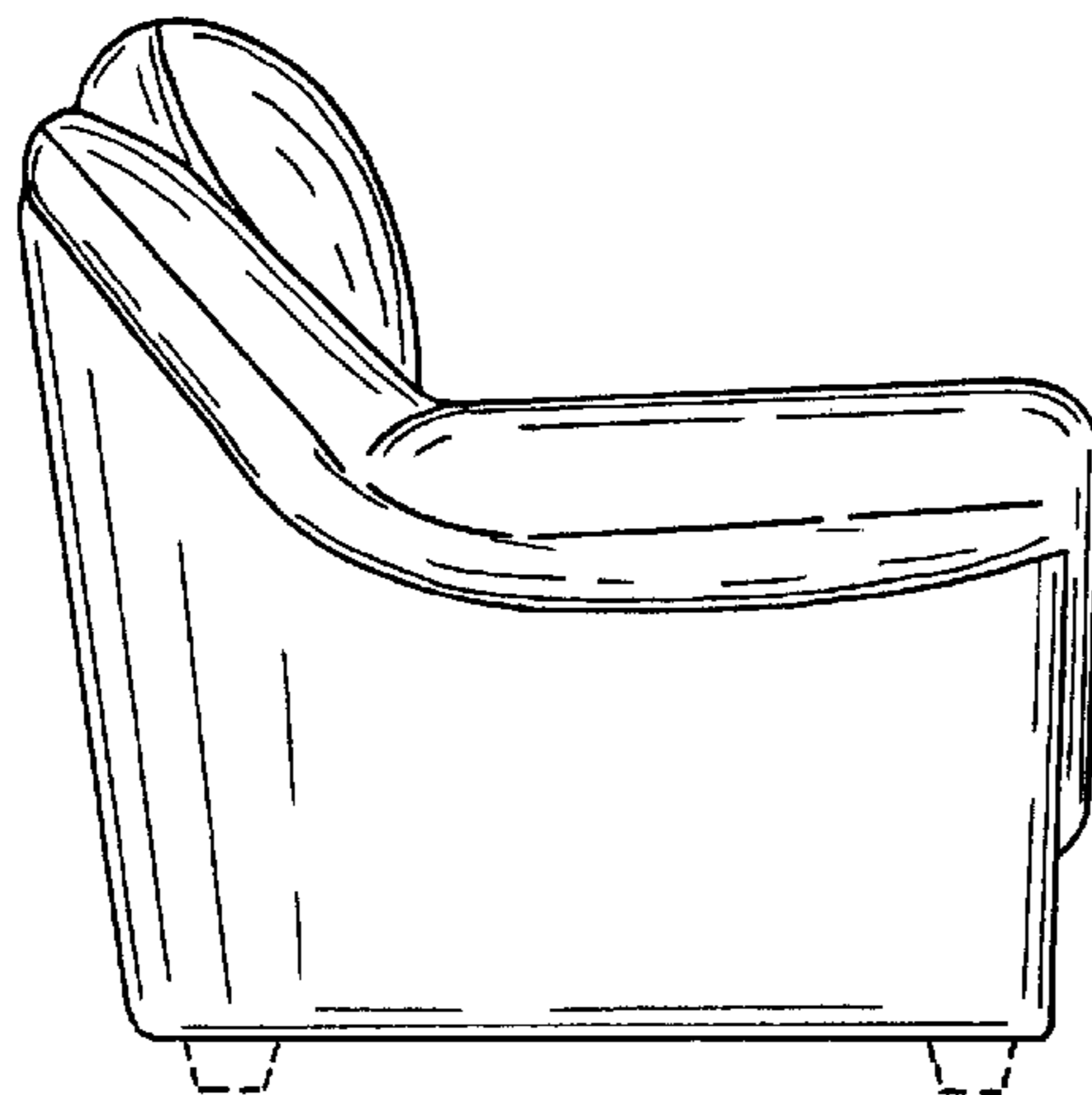

FIG. 4.

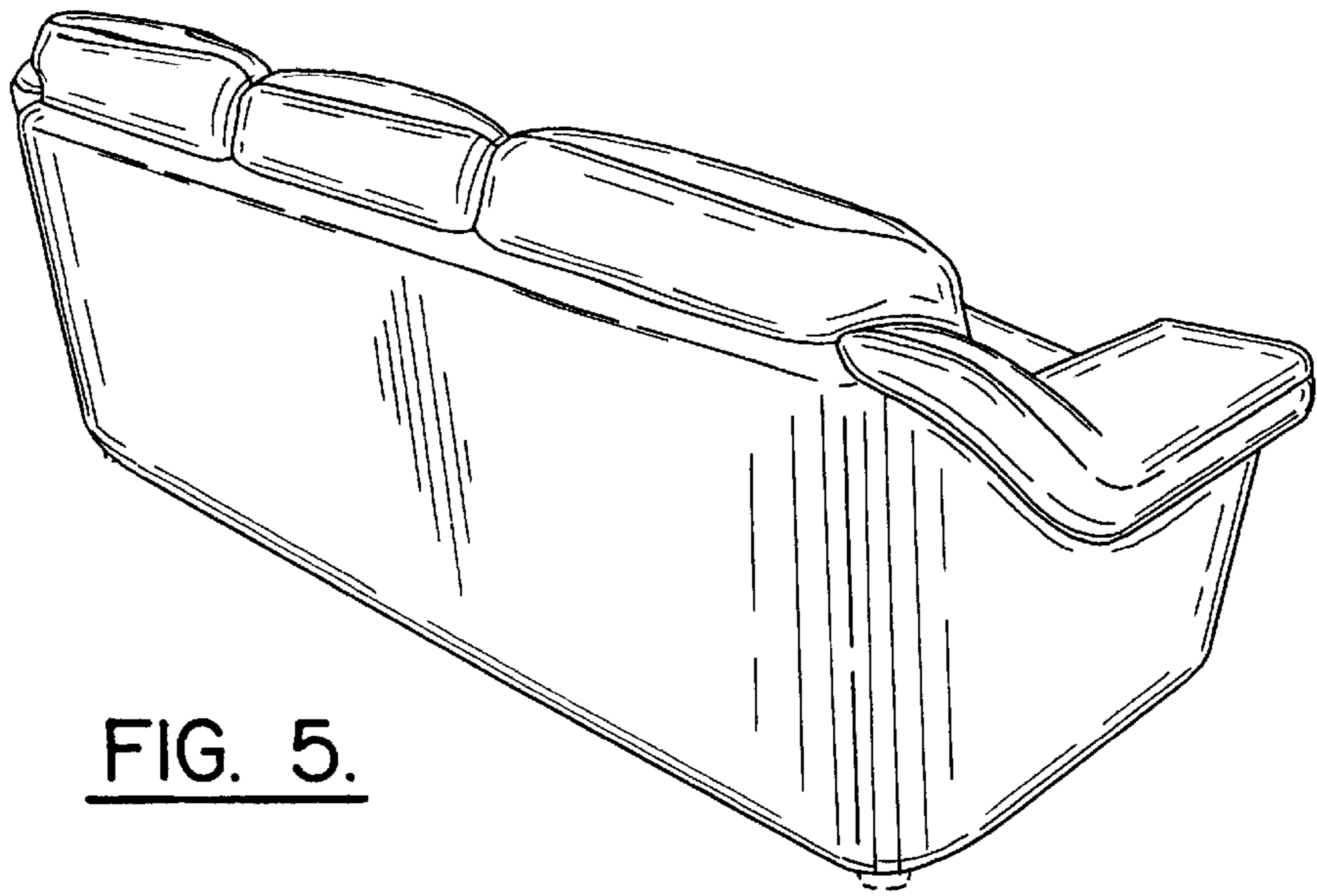

FIG. 5.

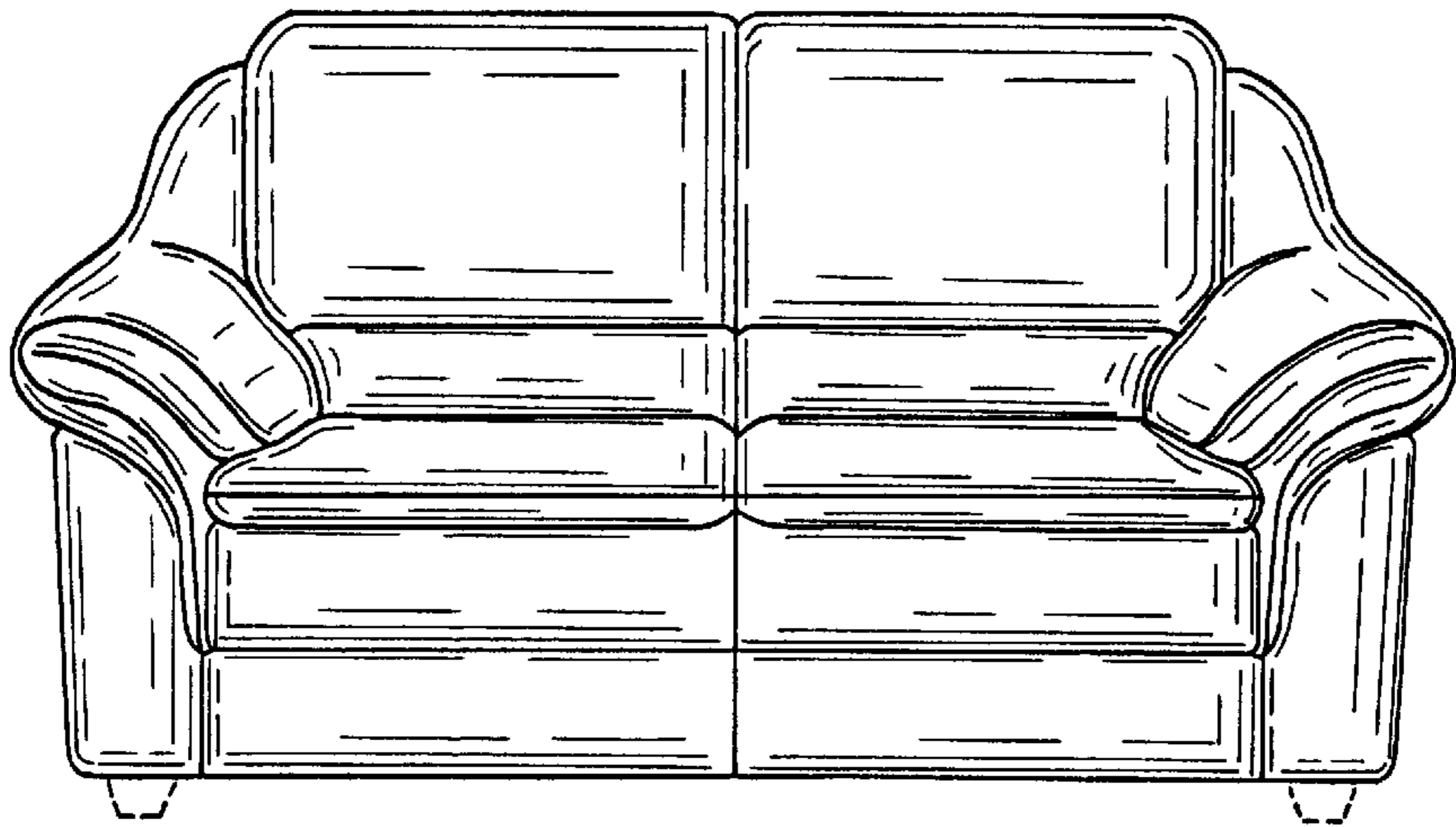

FIG. 6.

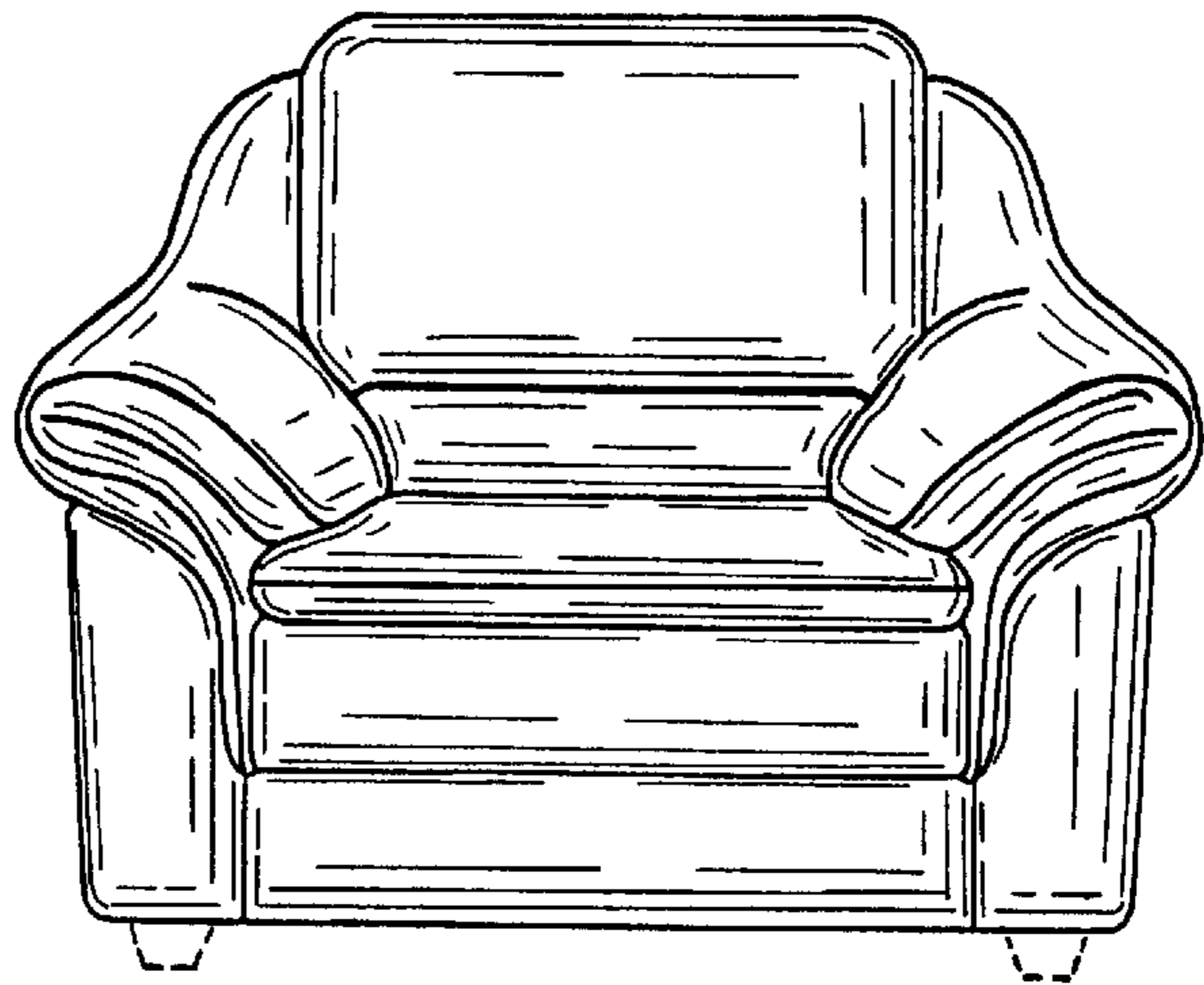

FIG. 7.

UNITED STATES PATENT AND TRADEMARK OFFICE
CERTIFICATE OF CORRECTION

PATENT NO. : D421,193

DATED : February 29, 2000

INVENTOR(S) : Natuzzi, et al

It is certified that error appears in the above-identified patent and that said Letters Patent is hereby corrected as shown below:

Title page, [56] References Cited, OTHER PUBLICATIONS, page 2, column 2, line 31, "1572" should read --1592--.

Signed and Sealed this
Twenty-eighth Day of November, 2000

Attest:



Q. TODD DICKINSON

Attesting Officer

Director of Patents and Trademarks