



US00D421162S

United States Patent [19]

[11] **Patent Number: Des. 421,162**

Roberts

[45] **Date of Patent: ** Feb. 22, 2000**

[54] **DISHWASHER DOOR HAVING CURVED TOP EDGE**

[75] Inventor: **Michael C. Roberts**, Newton, Iowa

[73] Assignee: **Maytag Corporation**, Newton, Iowa

[**] Term: **14 Years**

[21] Appl. No.: **29/093,865**

[22] Filed: **Sep. 21, 1998**

[51] **LOC (7) Cl. 15-05**

[52] **U.S. Cl. D32/3**

[58] **Field of Search D32/2, 3; 134/56 D, 134/58 D, 57 DL, 135, 200; 312/108, 109**

4,951,693	8/1990	Archambault	134/58 DL
5,151,884	9/1992	Griffith et al.	134/57 D
5,470,142	11/1995	Sargeant et al. .	
5,651,380	7/1997	Sargeant et al. .	
5,651,382	7/1997	Sargeant et al. .	
5,709,237	1/1998	Sargeant et al. .	
5,743,281	4/1998	Sargeant et al. .	
5,755,244	5/1998	Sargeant et al. .	

Primary Examiner—Mitchell Siegel
Attorney, Agent, or Firm—Zarley, McKee, Thomte, Voorhees & Sease

[57] CLAIM

We claim the ornamental design for a dishwasher door having curved top edge, as shown and described.

DESCRIPTION

FIG. 1 is a perspective view of the dishwasher door. The broken line showing of the kitchen counter, cabinets and floor is for illustrative purposes only and forms no part of the claim design.

FIG. 2 is a top plan view of the door.

FIG. 3 is a front elevational view of the door.

FIG. 4 is a bottom view of the door.

FIG. 5 is a rear elevational view of the door; and,

FIG. 6 is a side elevational view of the door taken from the right-hand side of FIG. 3, the opposite side view being the same.

[56] References Cited

U.S. PATENT DOCUMENTS

D. 153,913	5/1949	Bartlett	D32/2
D. 164,740	10/1951	Stanitz	D32/2
D. 205,959	10/1966	Smith	D32/2
D. 320,487	10/1991	Marks et al.	D32/3
D. 320,488	10/1991	Marks et al.	D32/3
D. 320,489	10/1991	Marks et al.	D32/3
D. 377,853	2/1997	Sparks	D32/3
D. 385,070	10/1997	Hughes et al.	D32/3
D. 400,320	10/1998	Brace .	
D. 403,471	12/1998	Brace	D32/2
4,732,431	3/1988	Mason	312/109

1 Claim, 3 Drawing Sheets

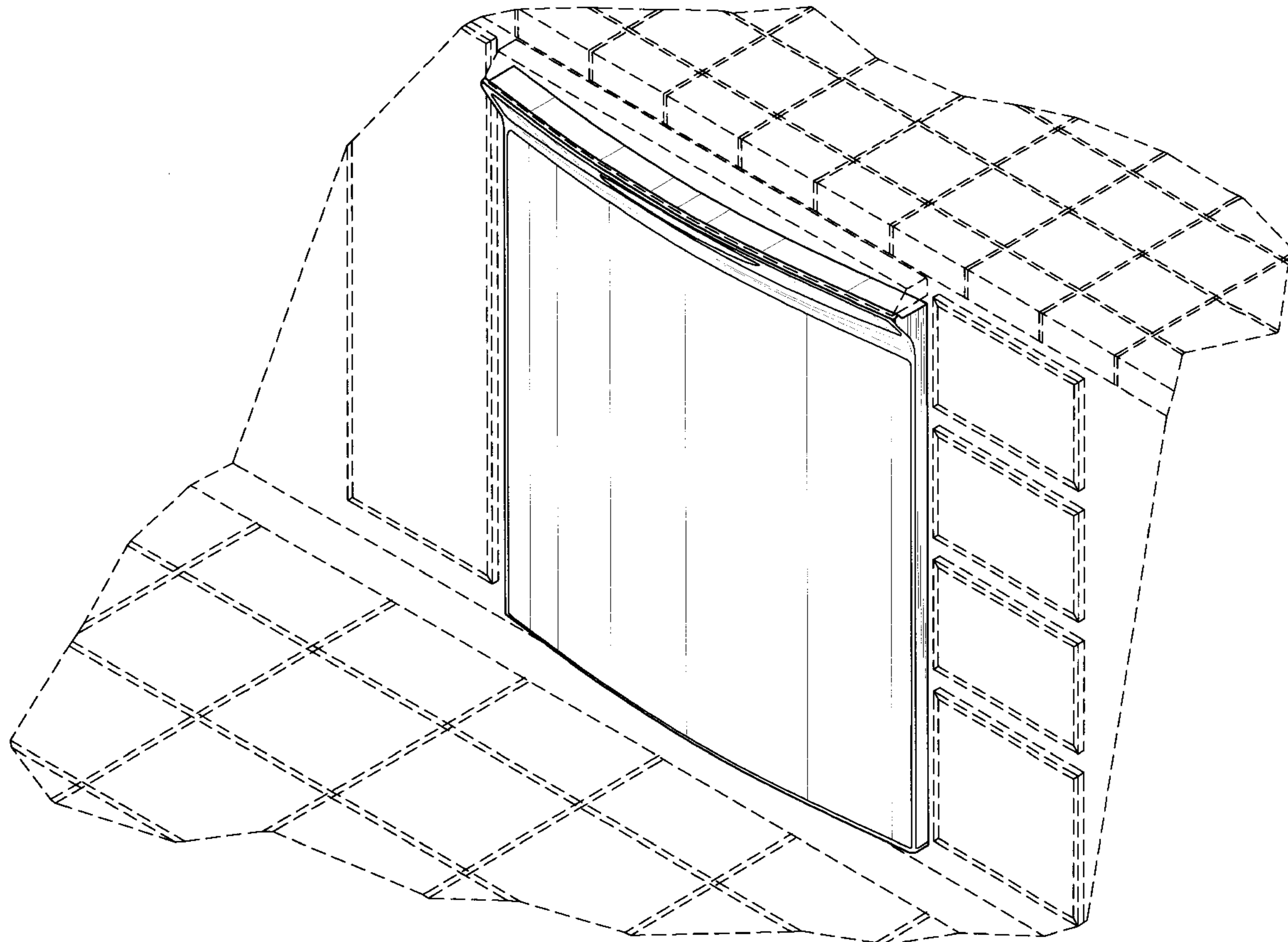

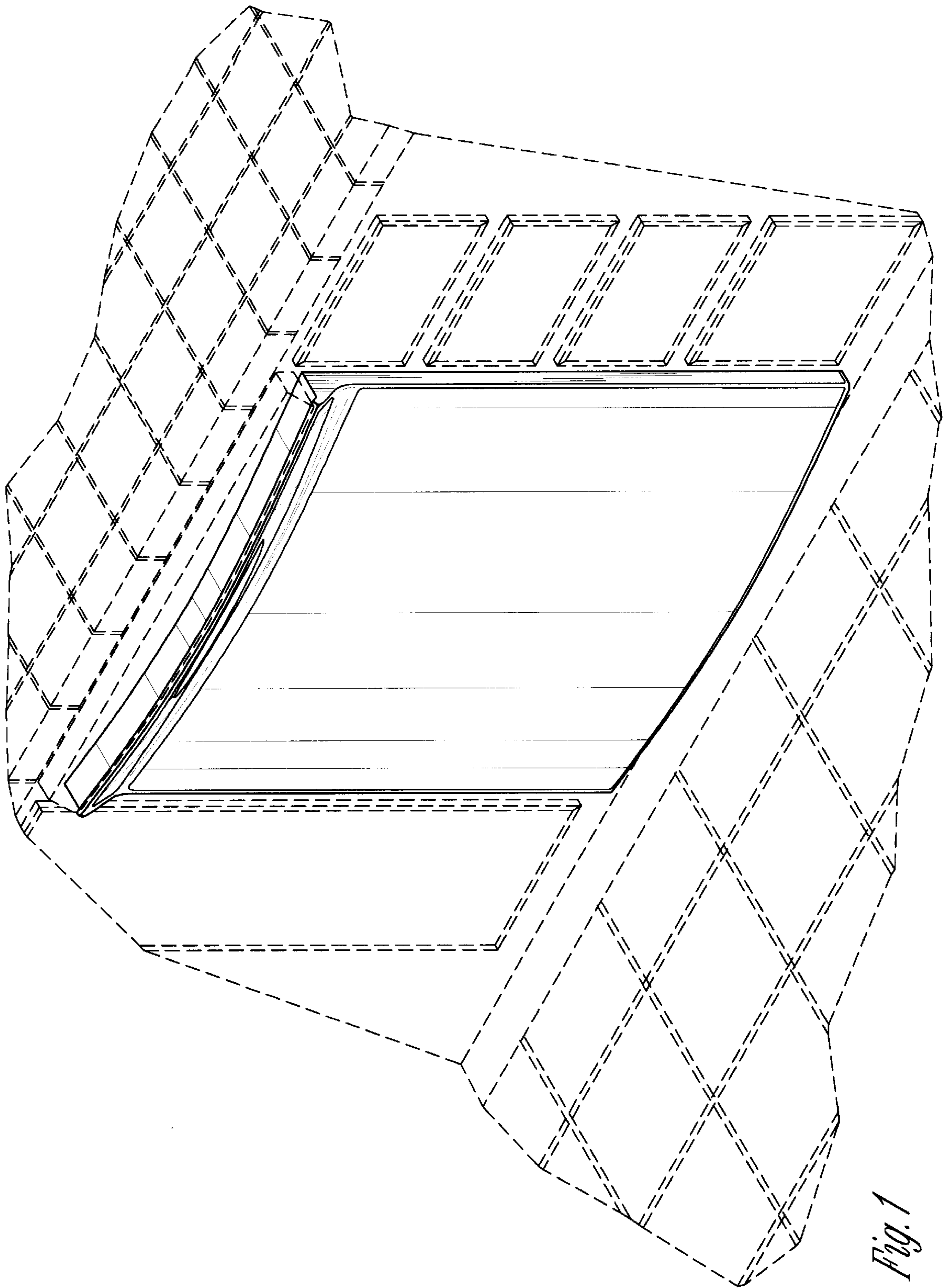

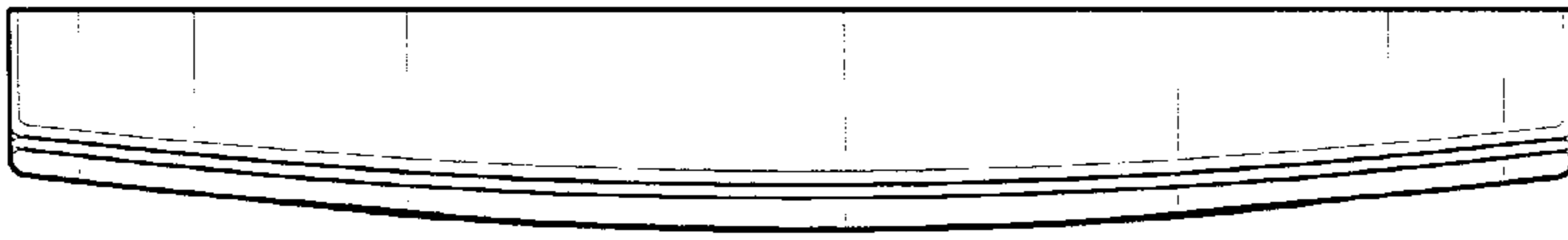

Fig. 2

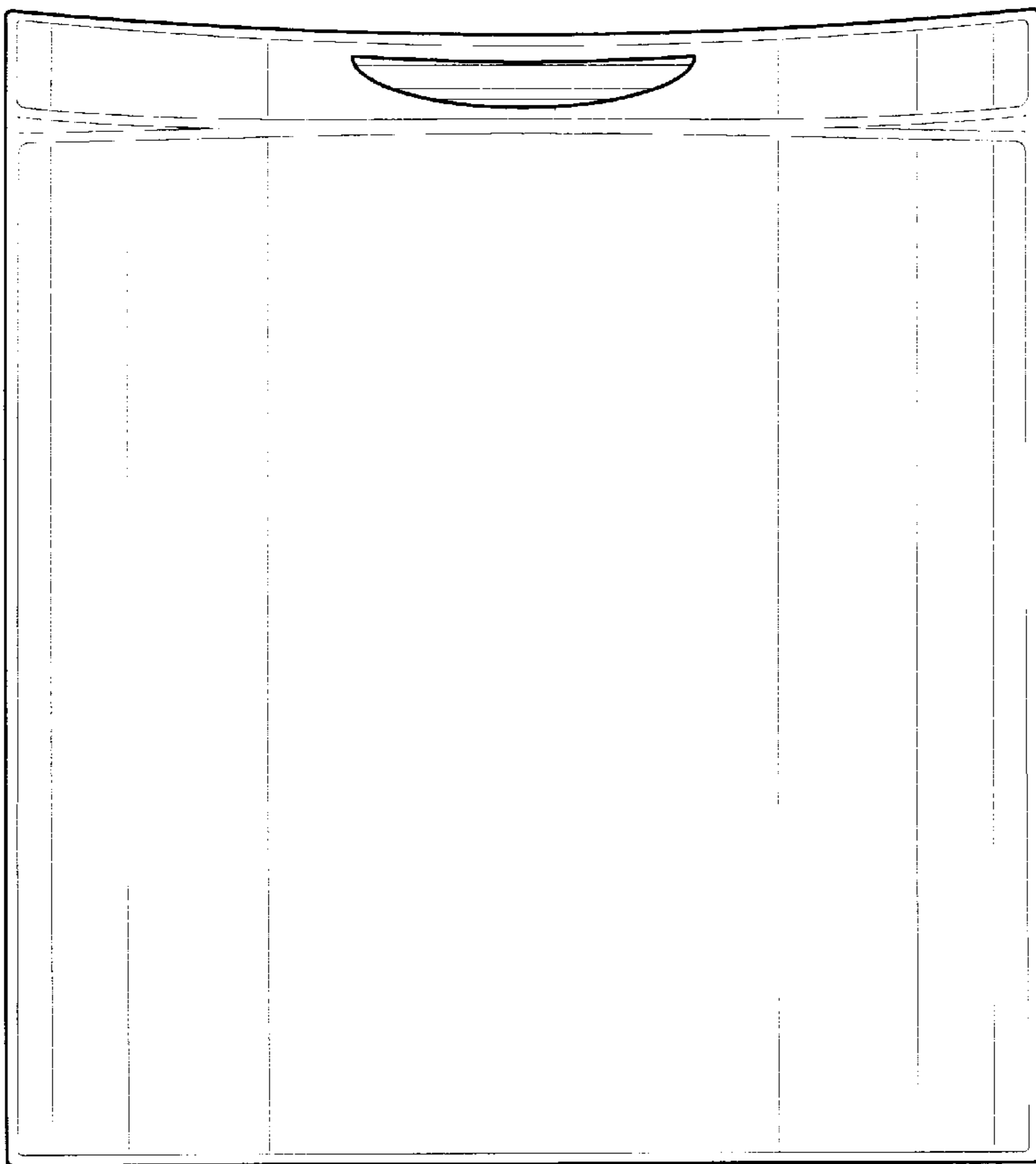

Fig. 3

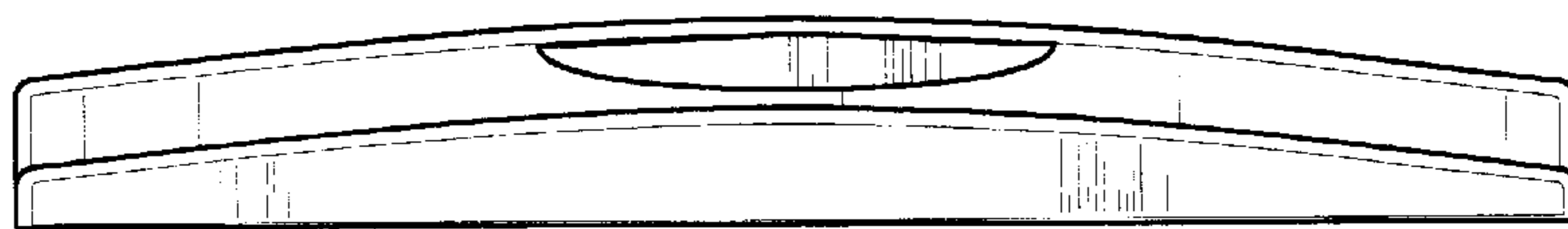

Fig. 4

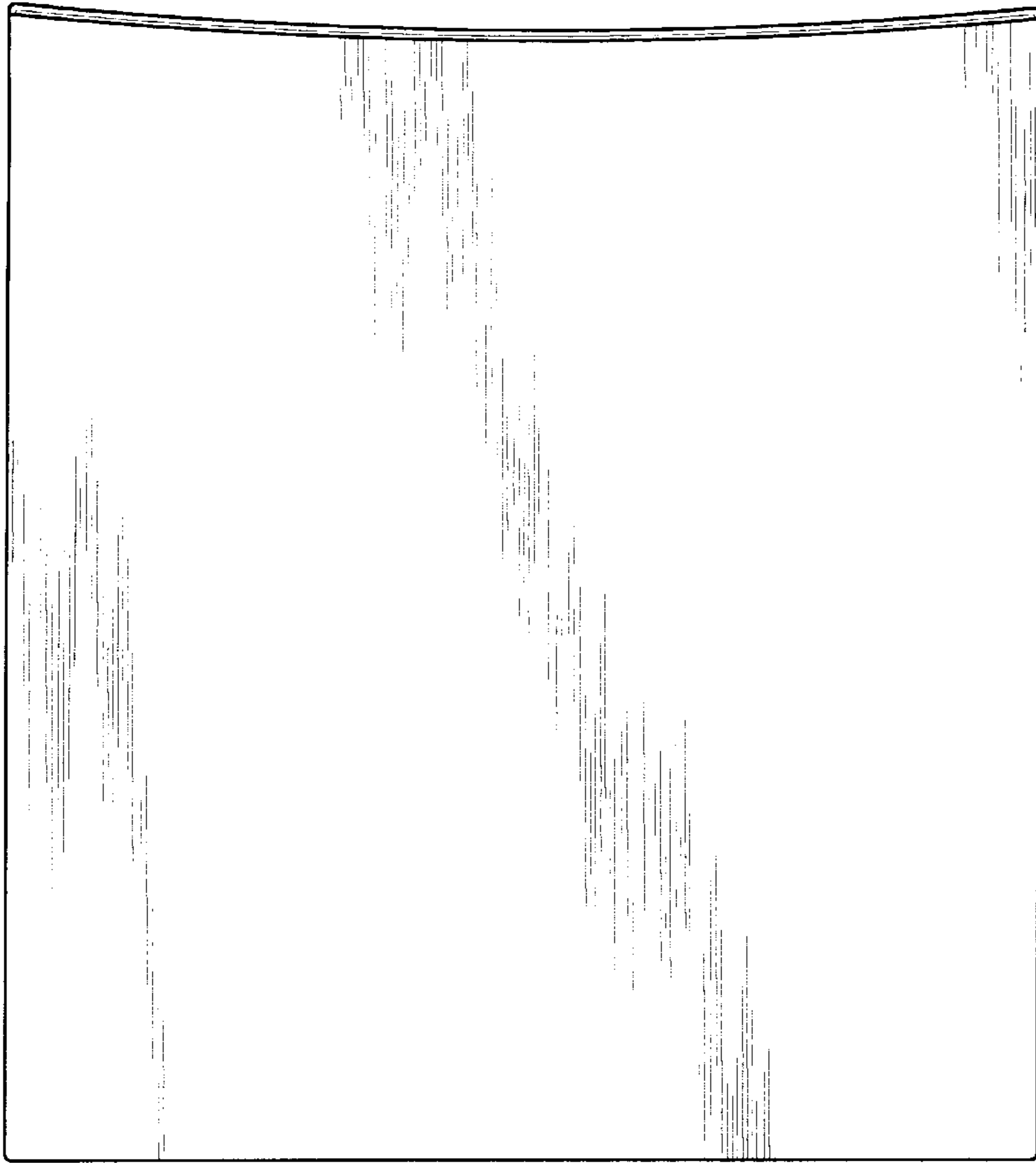

Fig. 5

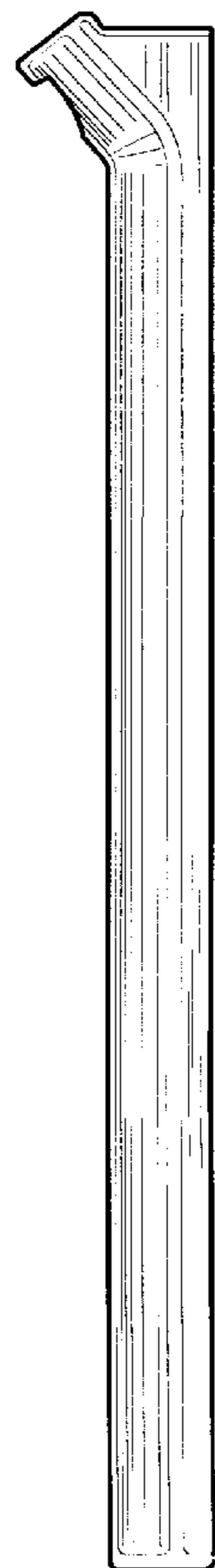

Fig. 6