



US00D421158S

United States Patent [19] Thomson

[11] **Patent Number: Des. 421,158**

[45] **Date of Patent: ** Feb. 22, 2000**

[54] **ANIMAL WATERER**

[75] Inventor: **Carter Thomson, Malcom, Iowa**

[73] Assignee: **Ahrens Agricultural Industries, Inc., Grinnell, Iowa**

[**] Term: **14 Years**

[21] Appl. No.: **29/108,563**

[22] Filed: **Jul. 29, 1999**

[51] **LOC (7) Cl. 30-07**

[52] **U.S. Cl. D30/121**

[58] **Field of Search D30/121-133;**
119/51.01, 51.04, 51.11, 51.12, 51.13, 51.5,
52.2, 52.4, 54

[56] **References Cited**

U.S. PATENT DOCUMENTS

D. 196,777	11/1963	Haynes	D30/132
D. 254,453	3/1980	Strong	D30/132
D. 257,691	12/1980	Peterson et al.	D30/132
D. 374,516	10/1996	Lillelund et al.	D30/132
D. 397,531	8/1998	Huff	D30/132
D. 400,316	10/1998	Kolterman et al.	D30/132
D. 402,428	12/1998	Chrisco	D30/121
D. 406,926	3/1999	Kolozsvari	D30/132

Primary Examiner—Louis S. Zarfaz

Assistant Examiner—Catherine R. Oliver

Attorney, Agent, or Firm—Zarley,McKee,Thomte,Voorhees
& Sease

[57] **CLAIM**

I claim the ornamental design for an animal waterer, as shown and described.

DESCRIPTION

FIG. 1 is a frontal perspective view of an animal waterer showing my new design.

FIG. 2 is a front elevational view thereof.

FIG. 3 is a rear elevational view thereof.

FIG. 4 is an elevational view thereof from the left side as viewed in FIG. 2 with the right side being a mirror image thereof.

FIG. 5 is an elevational view thereof from the left side as viewed in FIG. 3 with the right side being a mirror image thereof.

FIG. 6 is a top plan view thereof.

FIG. 7 is a bottom plan view thereof.

FIG. 8 is a frontal perspective view of an alternate embodiment.

FIG. 9 is a front elevational view thereof.

FIG. 10 is a rear elevational view thereof.

FIG. 11 is an elevational view thereof from the left side as viewed in FIG. 2 with the right side being a mirror image thereof.

FIG. 12 is an elevational view thereof from the left side as viewed in FIG. 3 with the right side being a mirror image thereof; and,

FIG. 13 is a bottom plan view thereof.

1 Claim, 9 Drawing Sheets

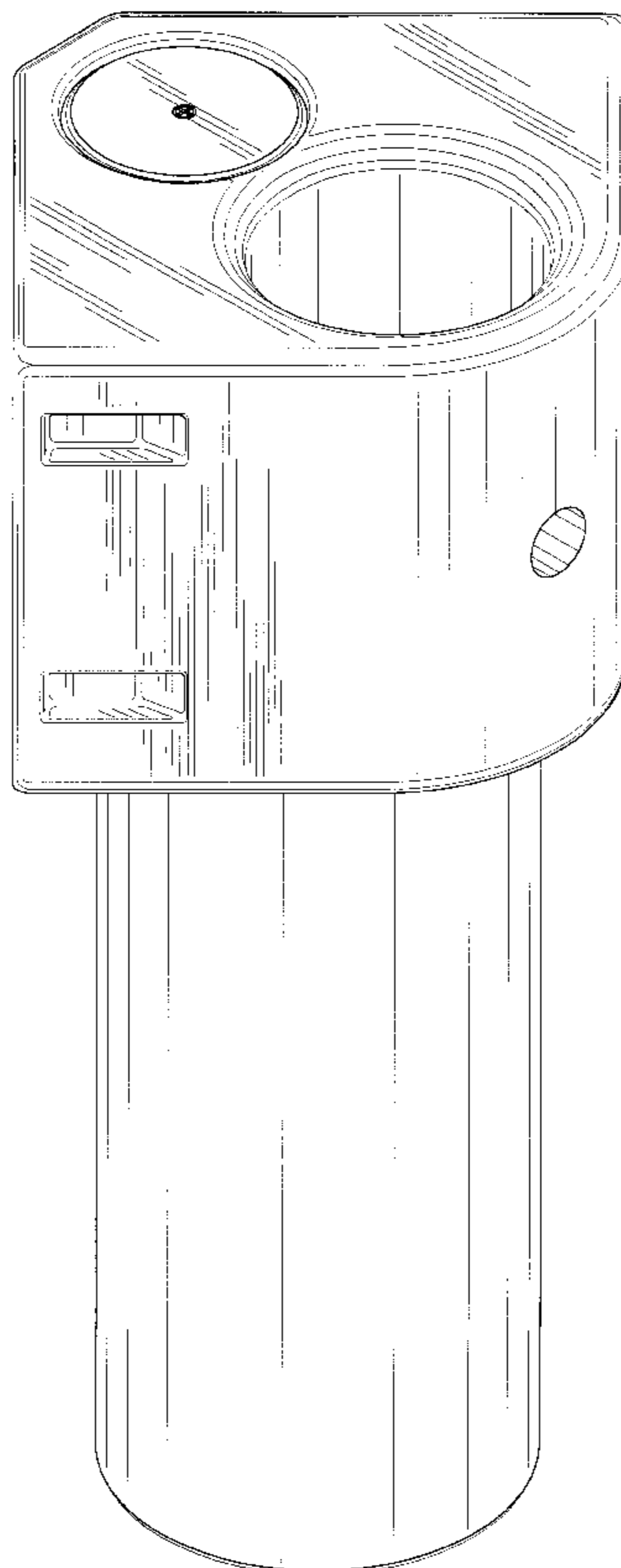

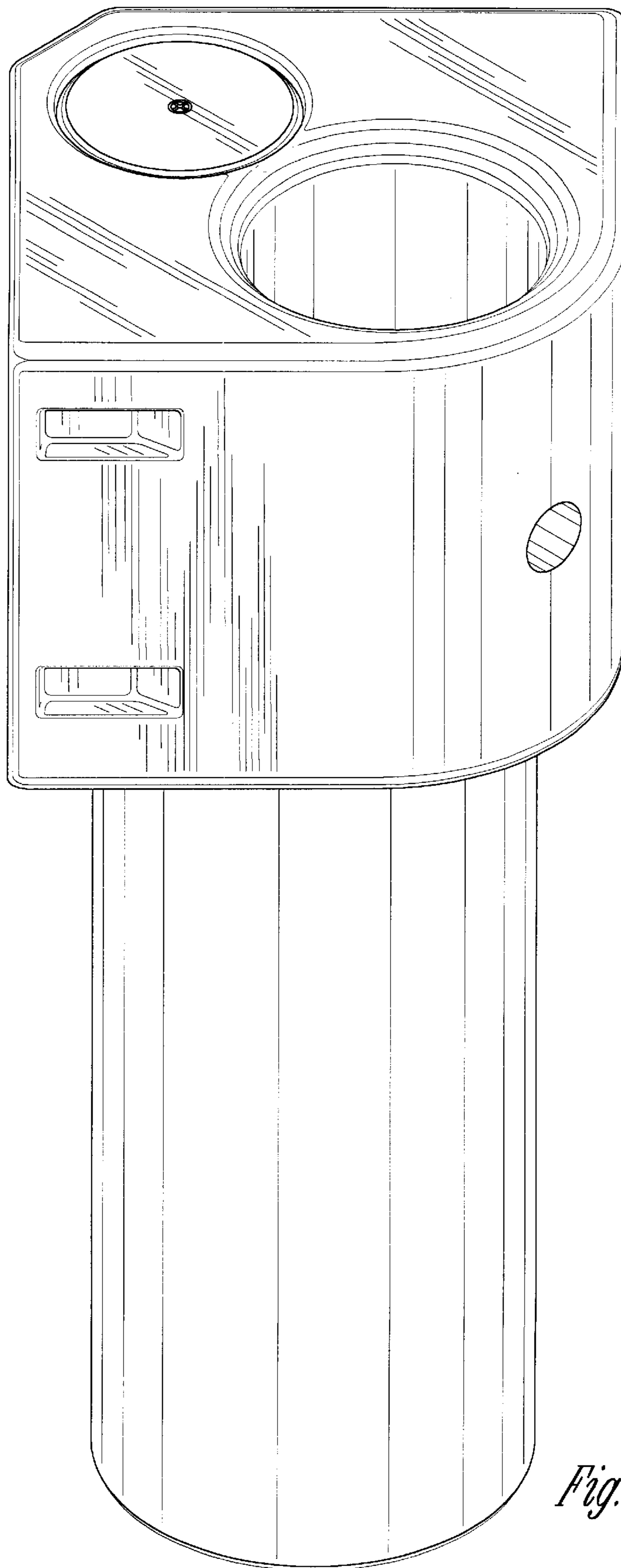

Fig. 1

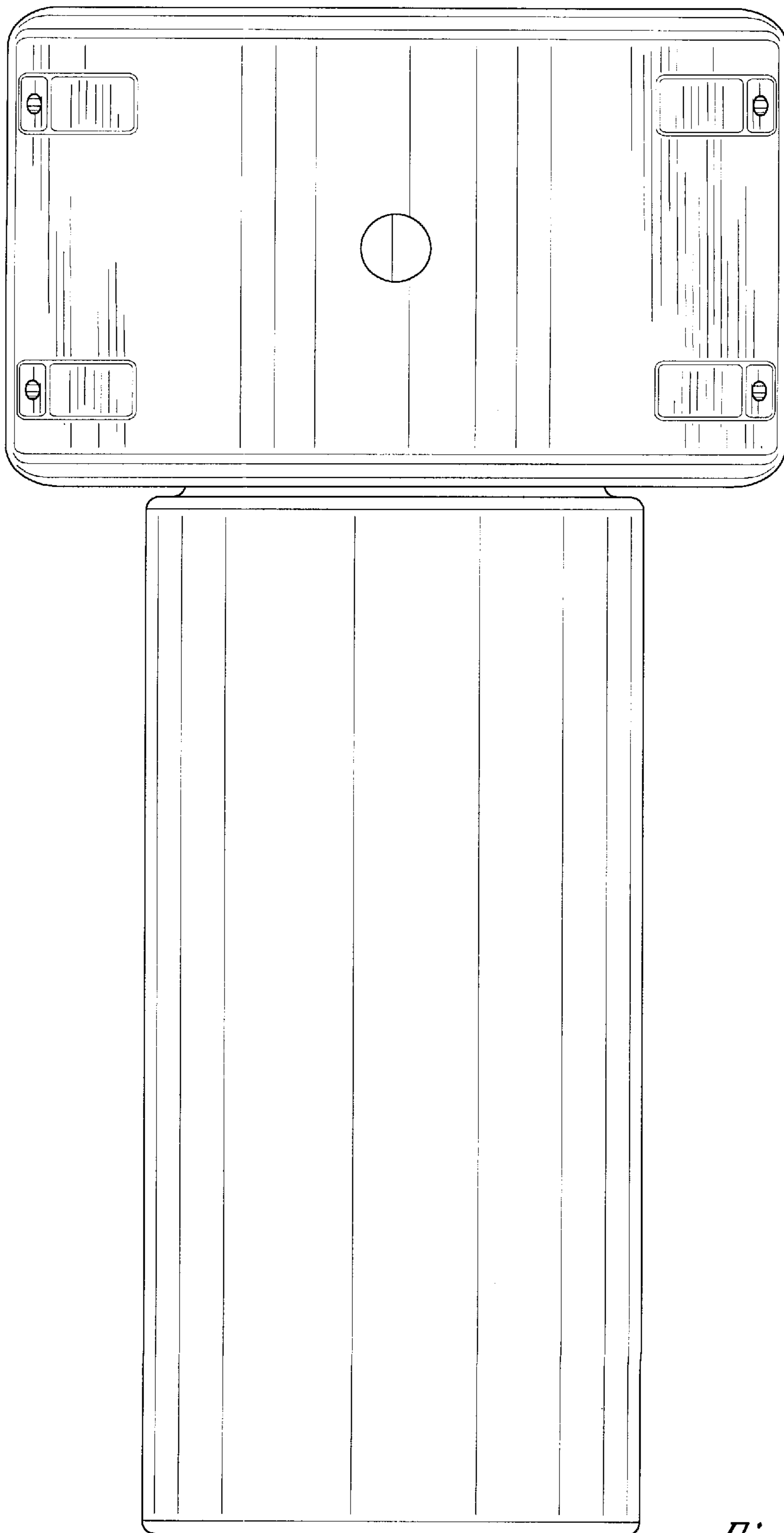

Fig. 2

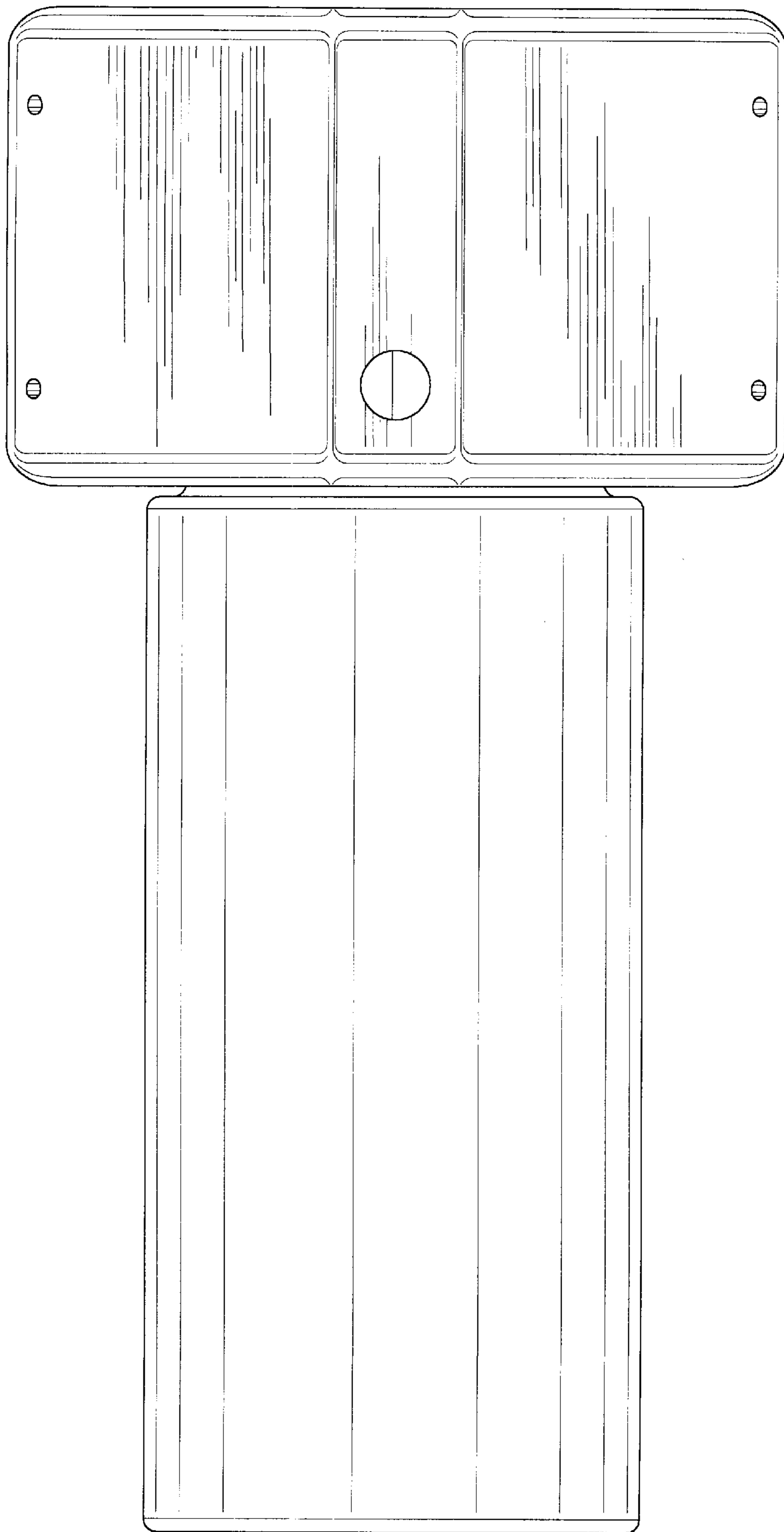

Fig. 3

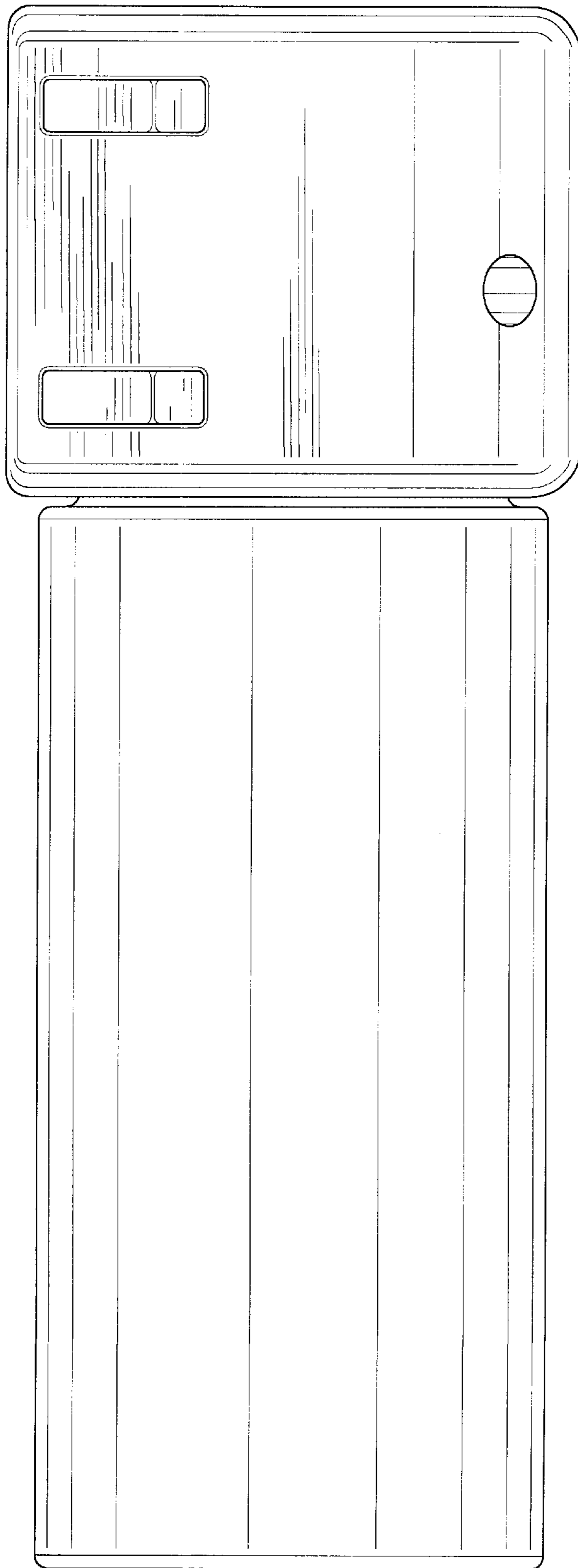

Fig. 4

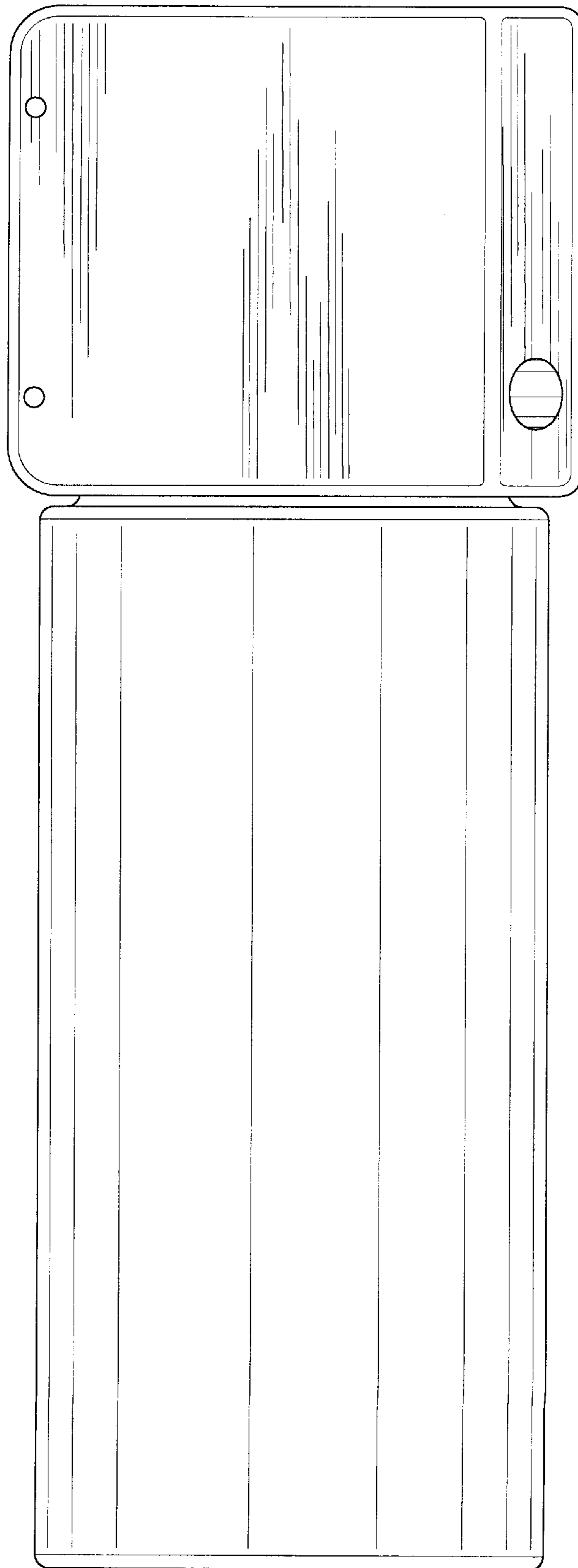

Fig. 5

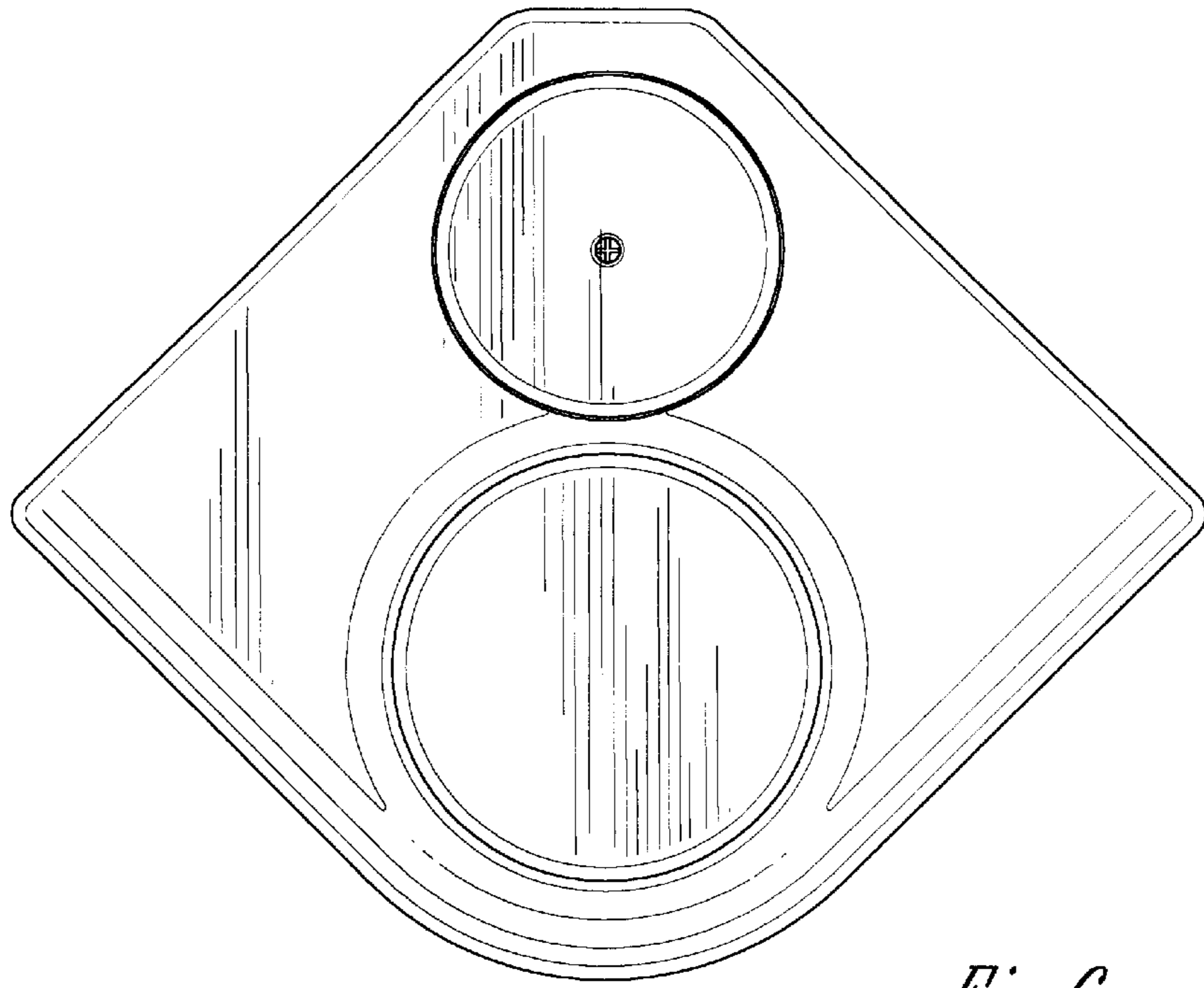

Fig. 6

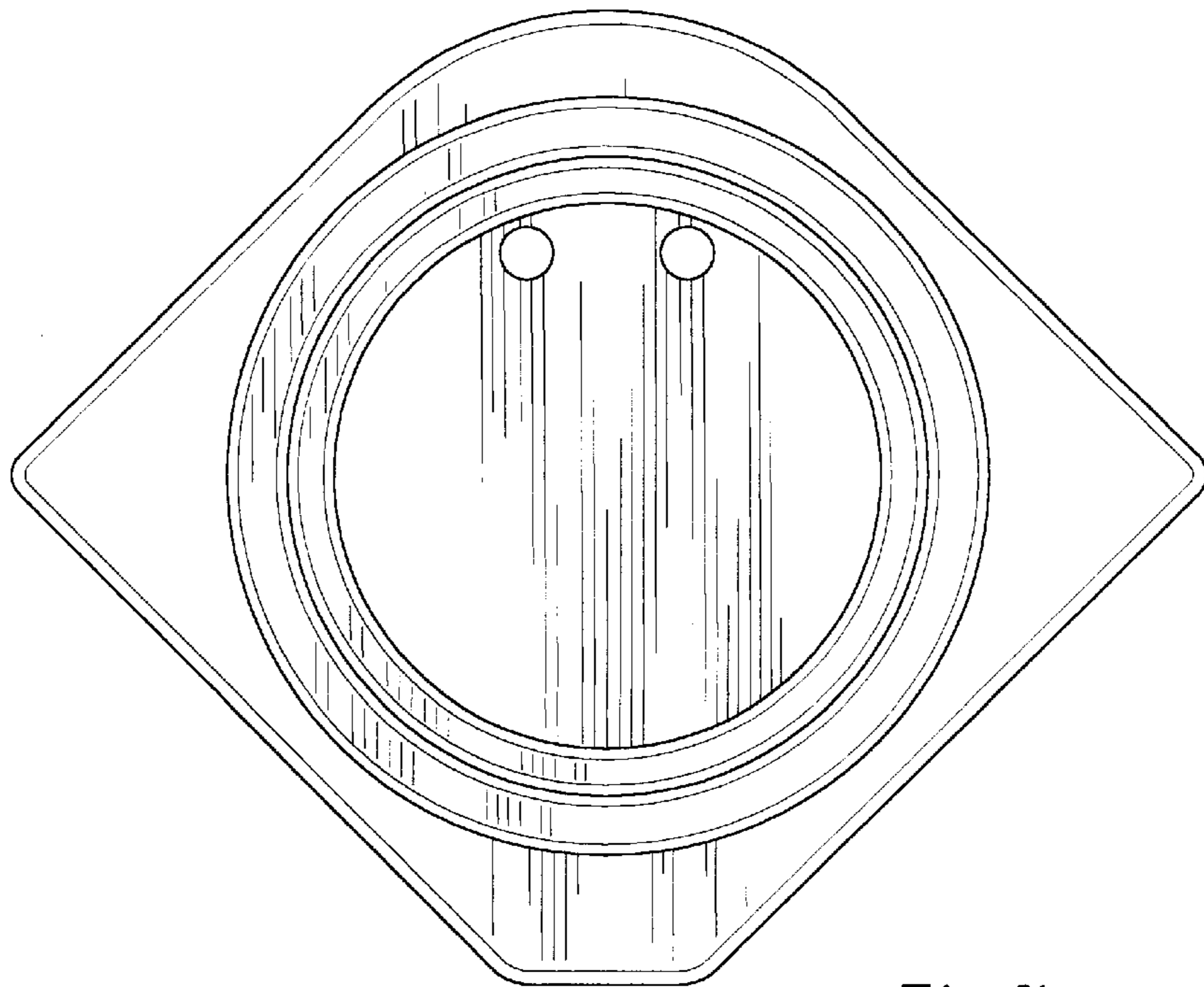

Fig. 7

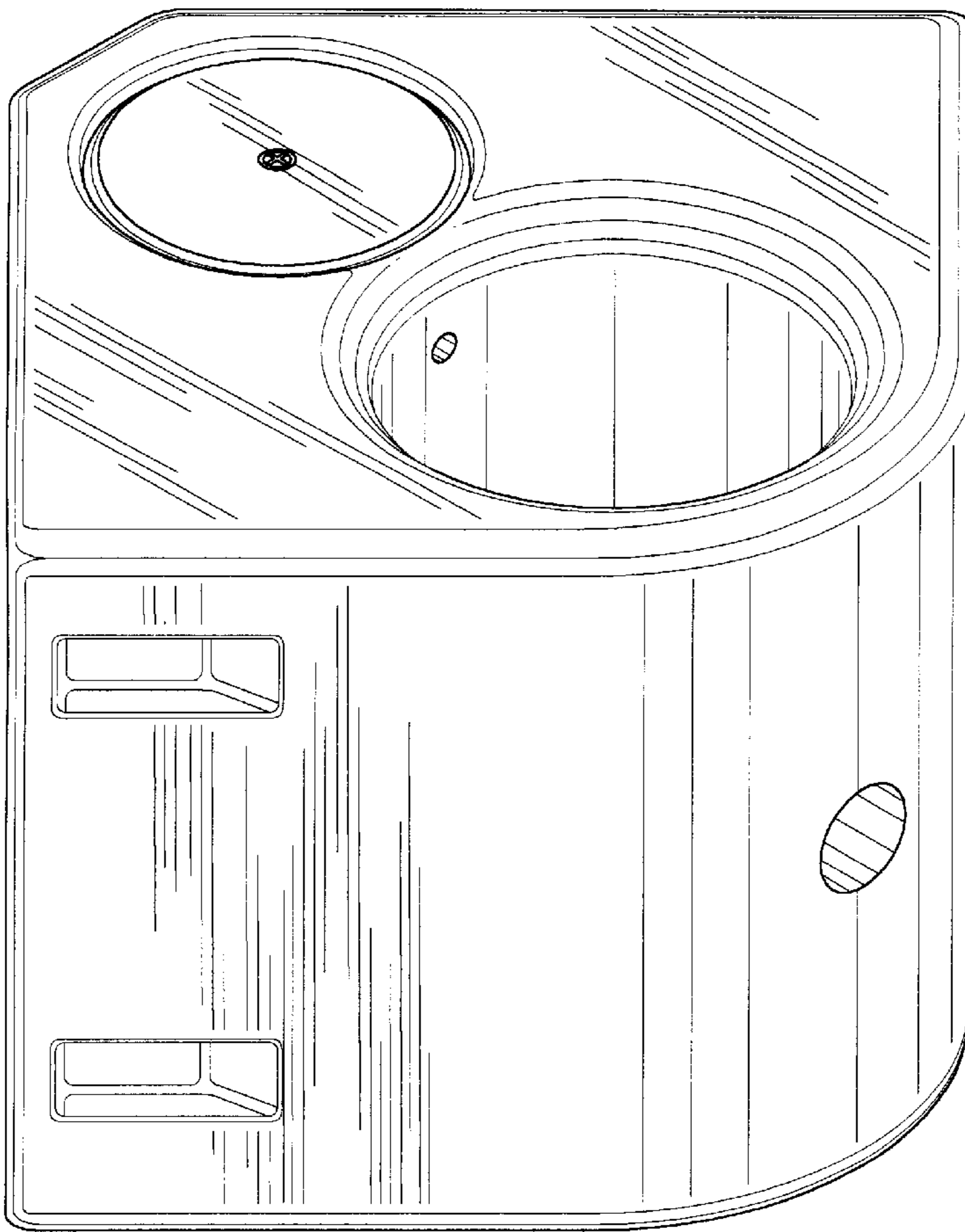

Fig. 8

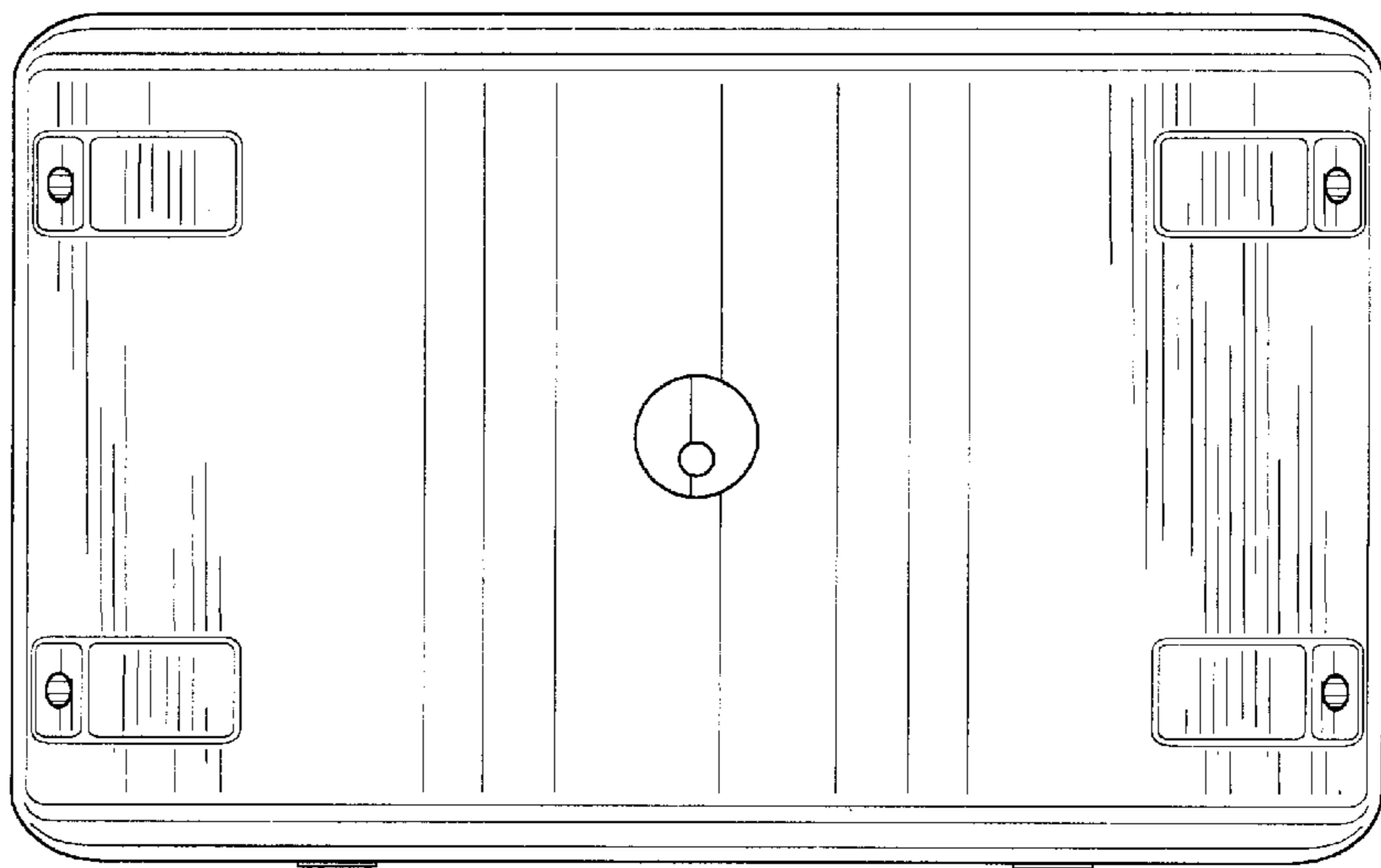

Fig. 9

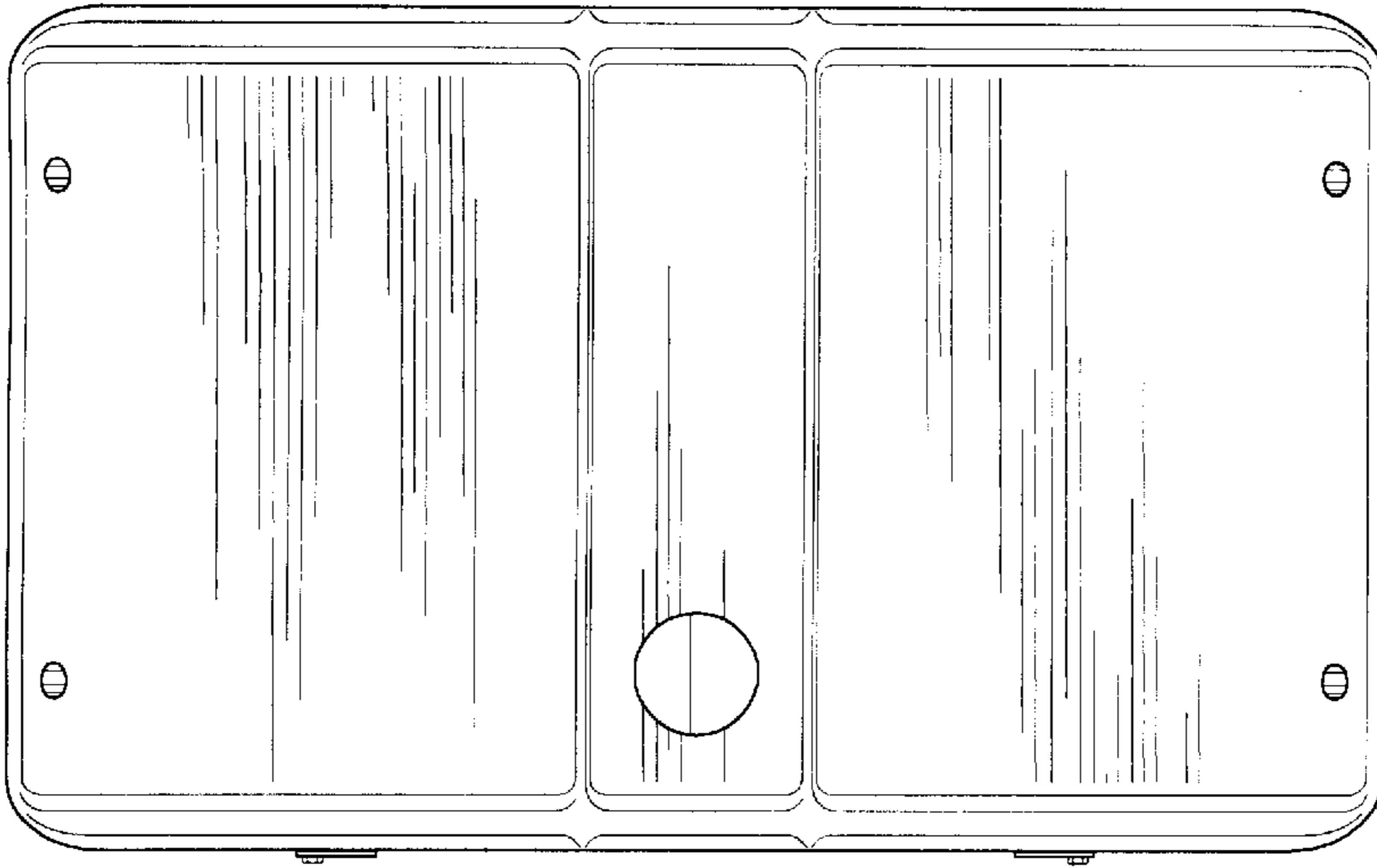

Fig. 10

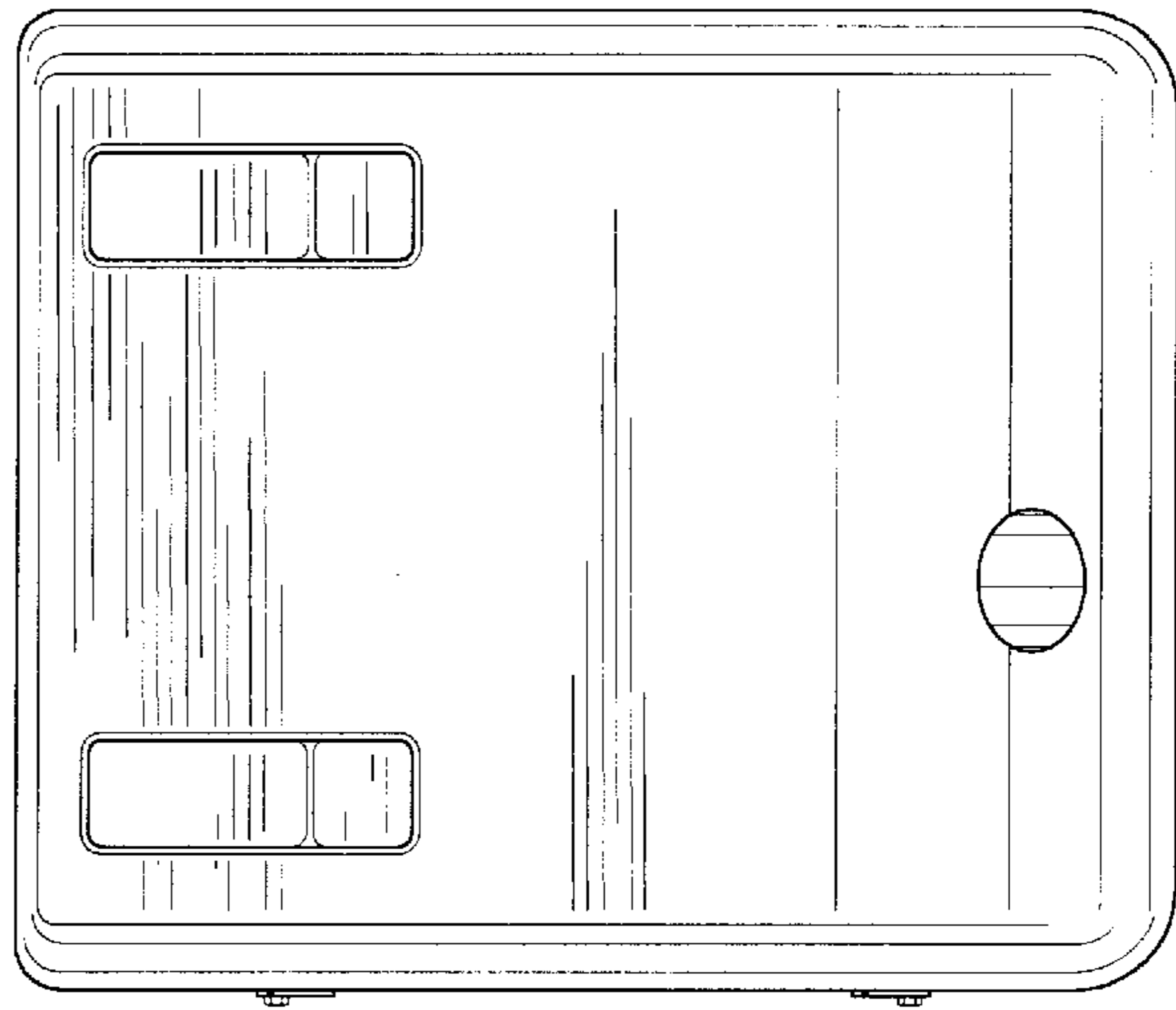

Fig. 11

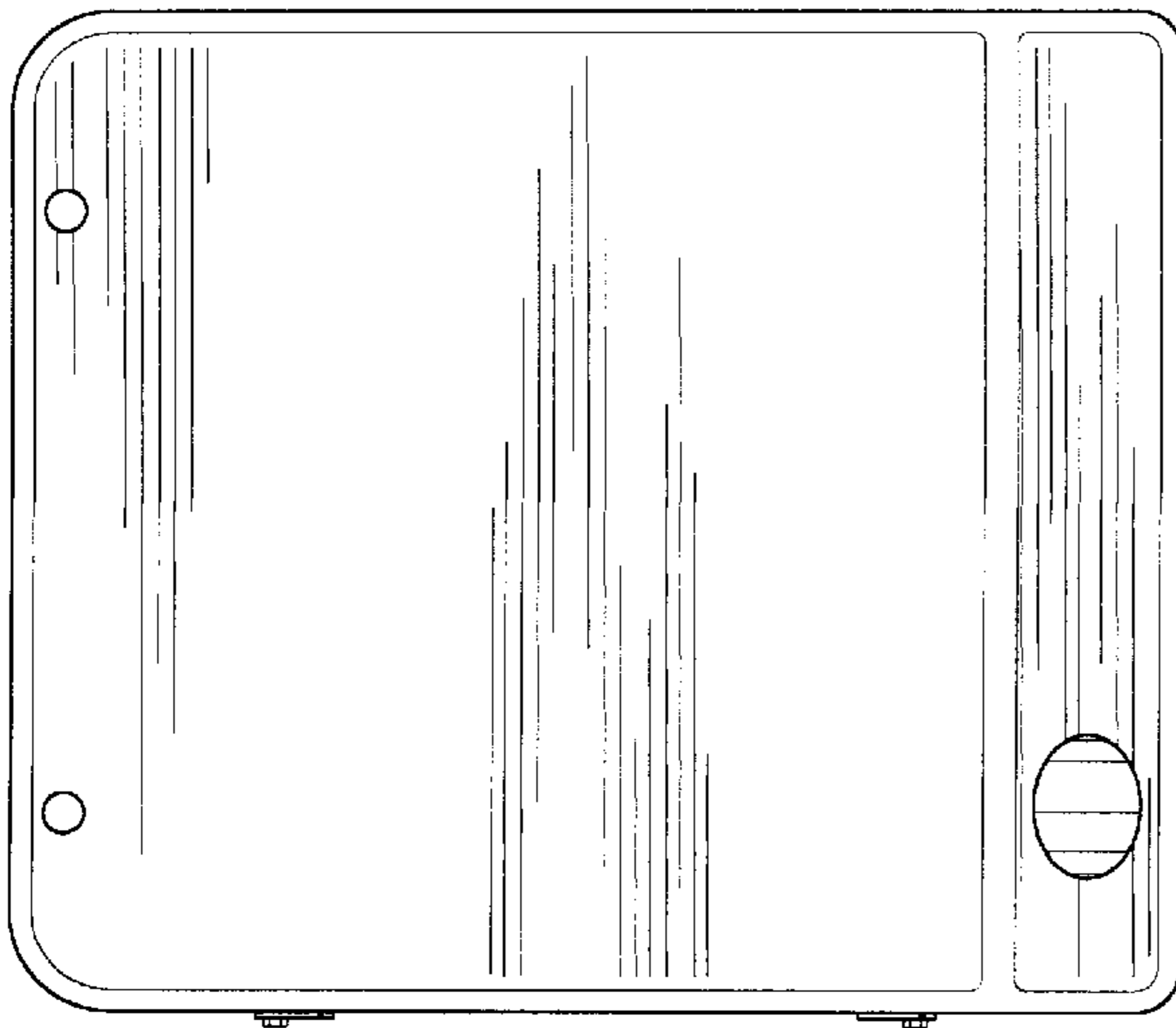

Fig. 12

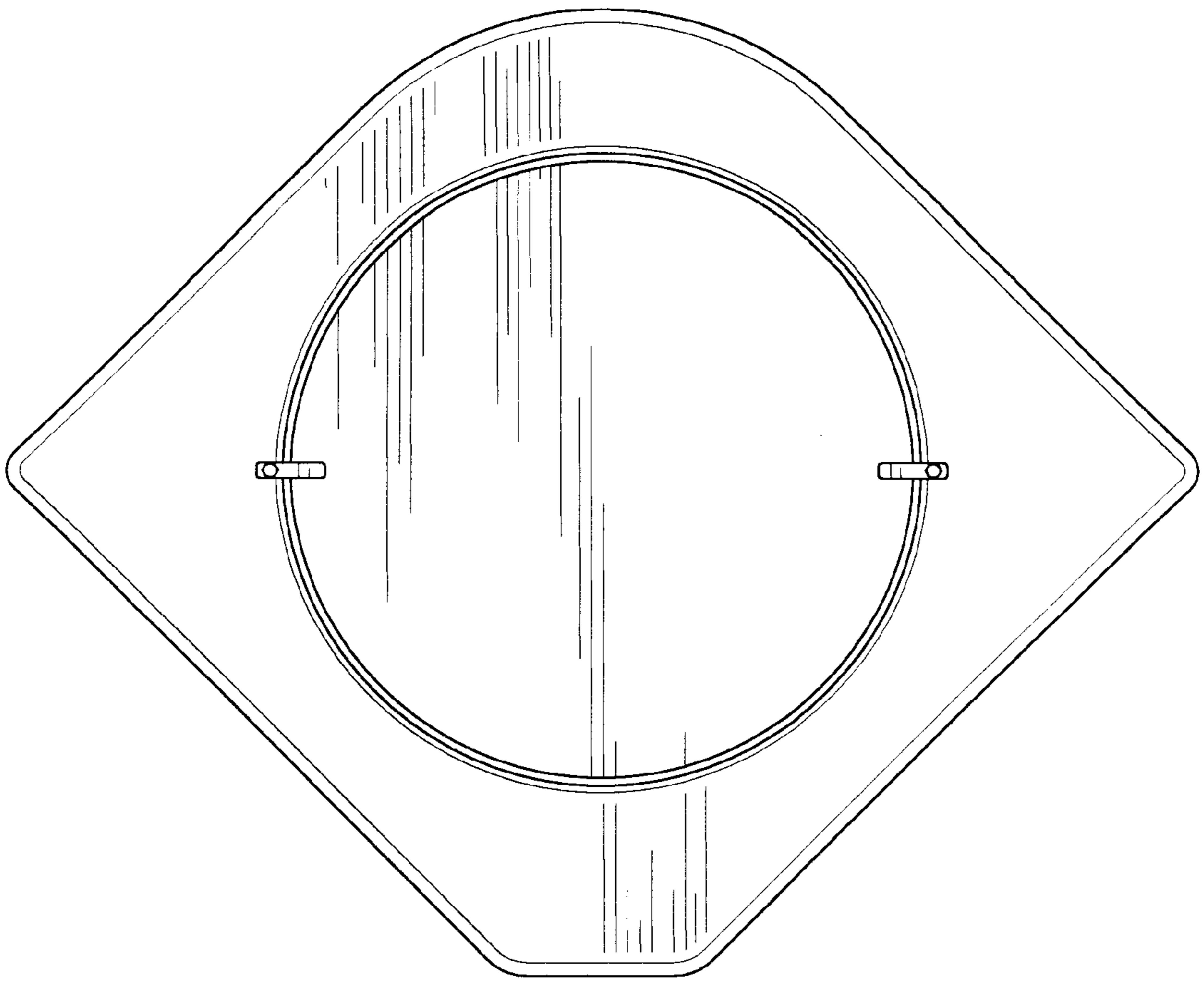

Fig. 13