



US00D421008S

# United States Patent [19] Matsuoka

[11] **Patent Number: Des. 421,008**

[45] **Date of Patent: \*\* Feb. 22, 2000**

[54] **COMBINED DISC RECORDER AND PLAYER**

[75] Inventor: **Yoshimichi Matsuoka**, Tokyo, Japan

[73] Assignee: **Sony Corporation**, Tokyo, Japan

[\*\*] Term: **14 Years**

[21] Appl. No.: **29/079,351**

[22] Filed: **Nov. 17, 1997**

[30] **Foreign Application Priority Data**

May 21, 1997 [JP] Japan ..... 9-55003

[51] **LOC (7) Cl.** ..... **14-01**

[52] **U.S. Cl.** ..... **D14/168; D14/156**

[58] **Field of Search** ..... D14/124, 135,  
D14/136, 156, 160-162, 167, 168, 188,  
299; 312/7.1; 348/10, 11, 706; 455/6.1;  
369/75.1, 77.1, 77.2

[56] **References Cited**

**U.S. PATENT DOCUMENTS**

D. 322,067 12/1991 Yamakawa ..... D14/168

D. 327,682 7/1992 Shimazu ..... D14/168  
D. 330,202 10/1992 Adiwono ..... D14/168  
D. 350,960 9/1994 Sakata et al. .... D14/188 X

*Primary Examiner*—Nanda Bondade  
*Attorney, Agent, or Firm*—Foley & Lardner

[57] **CLAIM**

The ornamental design for a combined disc recorder and player, as shown and described.

**DESCRIPTION**

FIG. 1 is a perspective view of a combined disc recorder and player showing my new design; FIG. 2 is a top plan view thereof; FIG. 3 is a left side elevational view thereof; FIG. 4 is a front elevational view thereof; FIG. 5 is a bottom plan view thereof; FIG. 6 is a right side elevational view thereof; FIG. 7 is a rear elevational view thereof; and, FIG. 8 is a perspective view thereof, the broken line showing of the controller is for illustrative purposes only and forms no part of the claimed design.

**1 Claim, 5 Drawing Sheets**

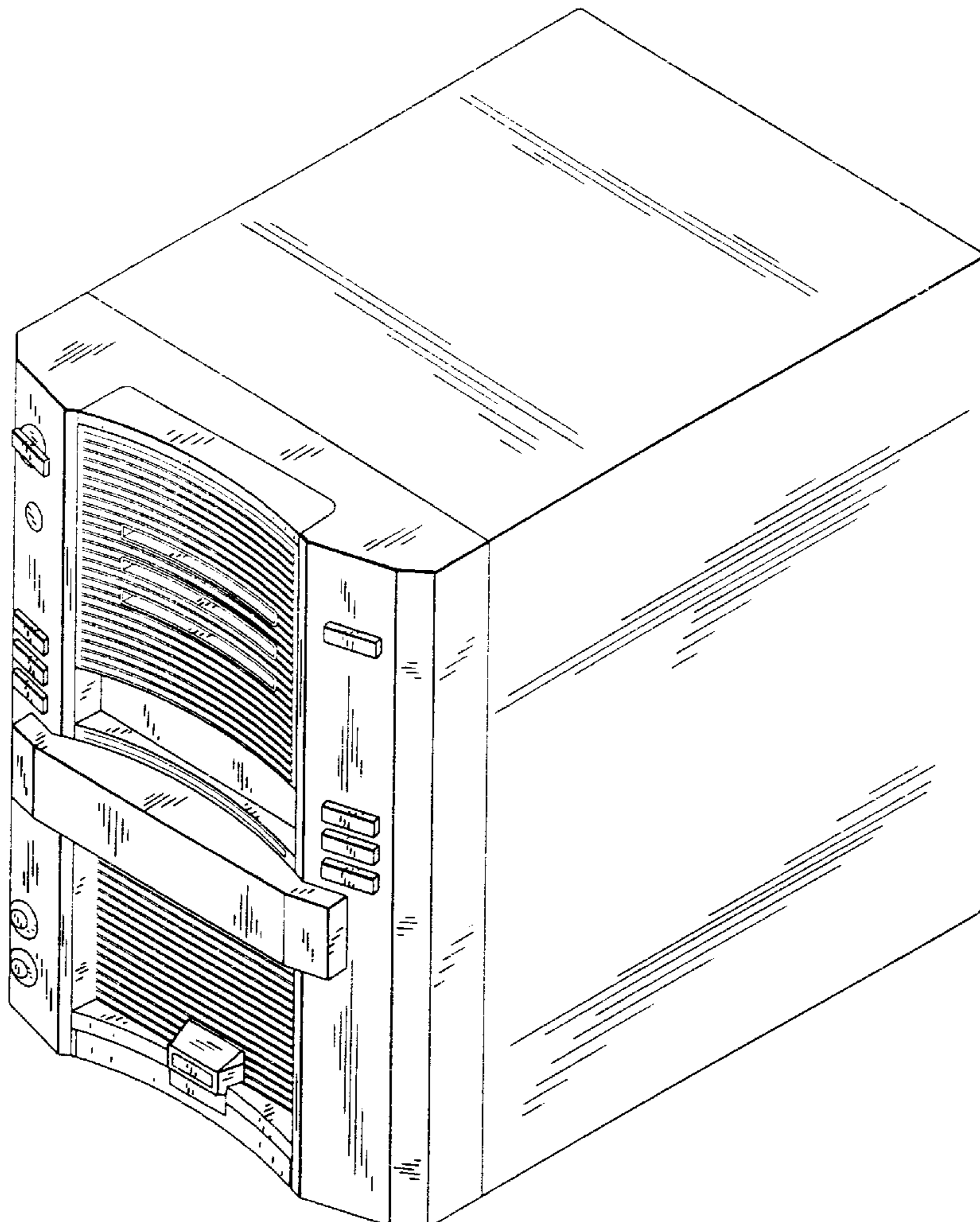

FIG. 1

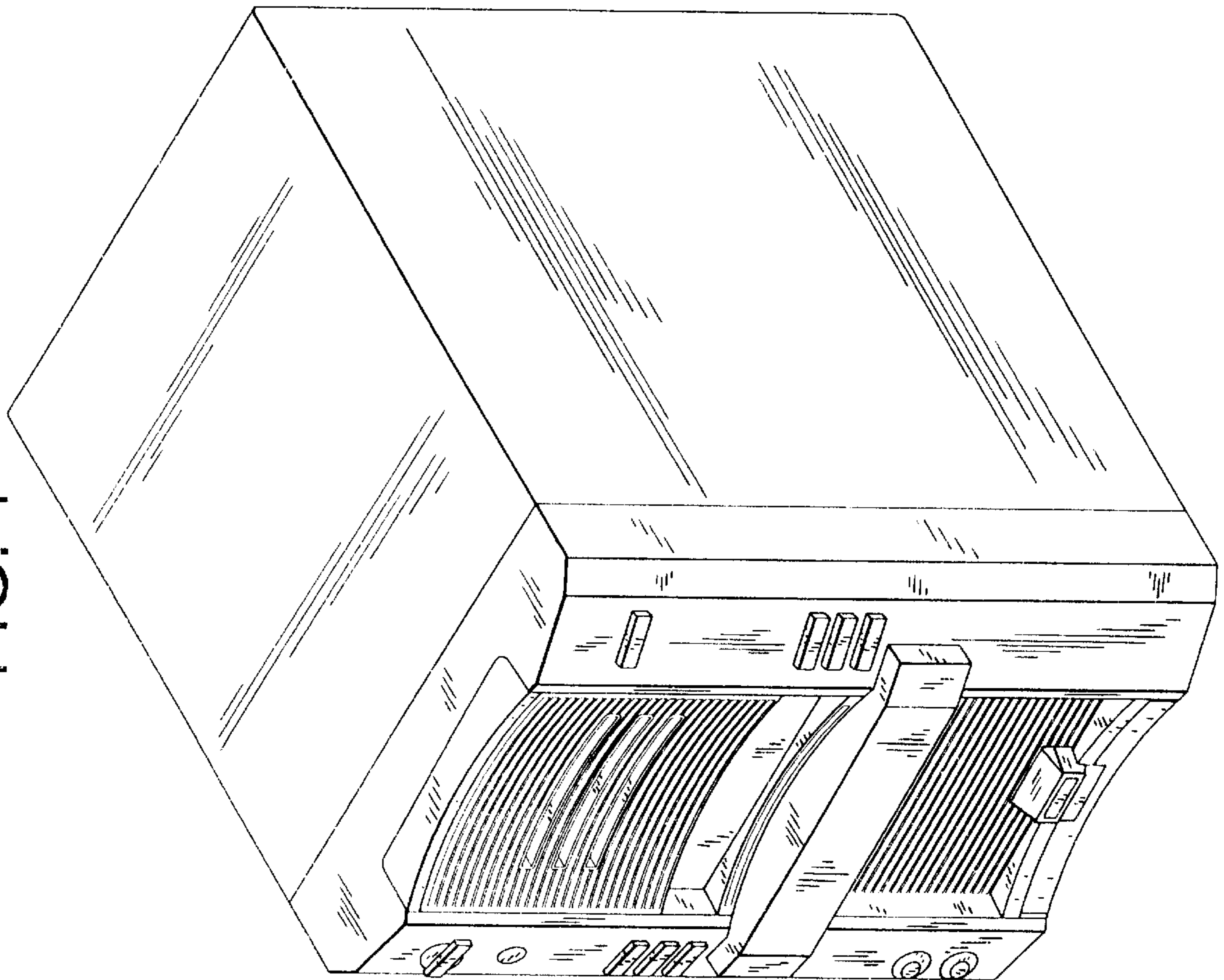

FIG. 2

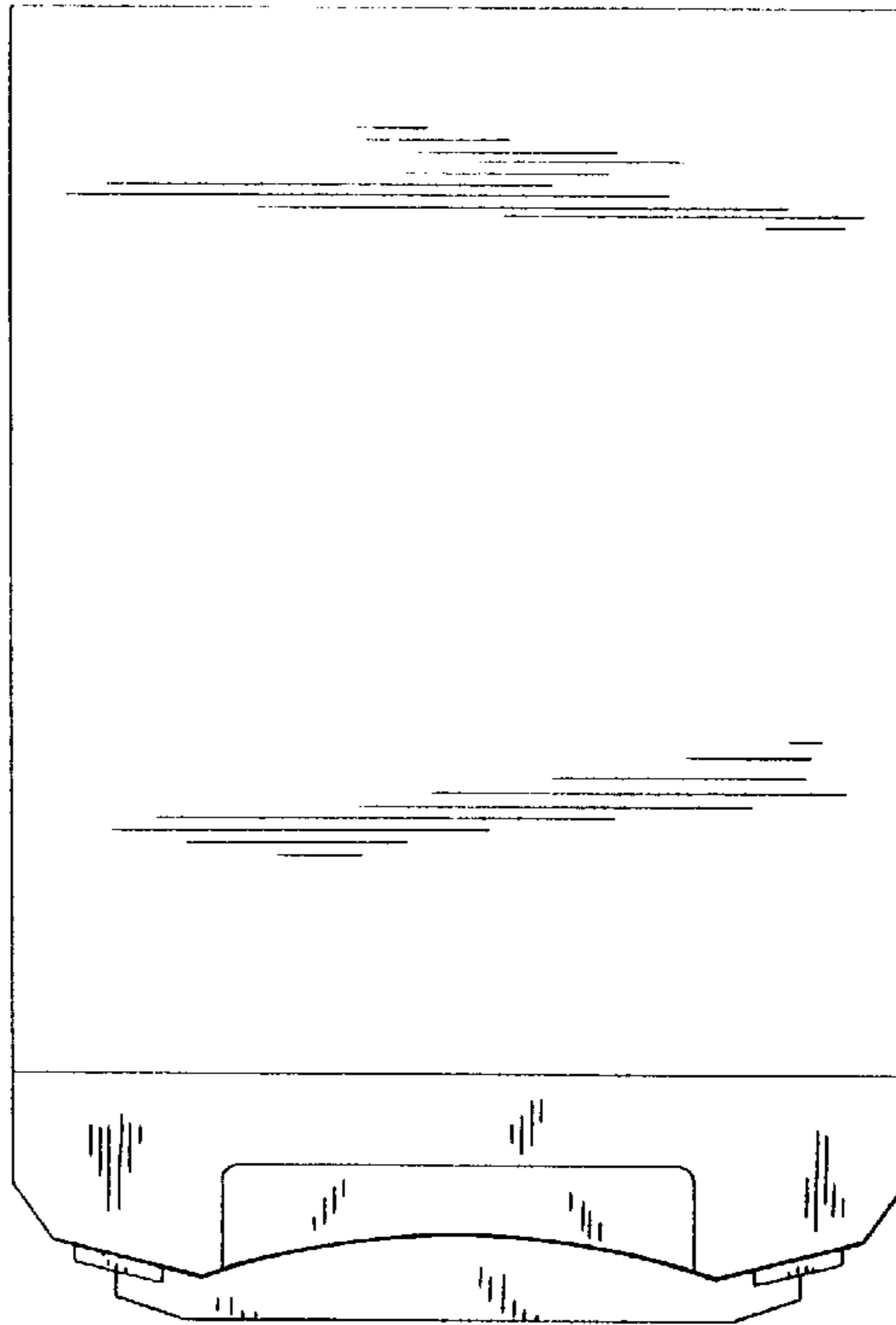

FIG. 5

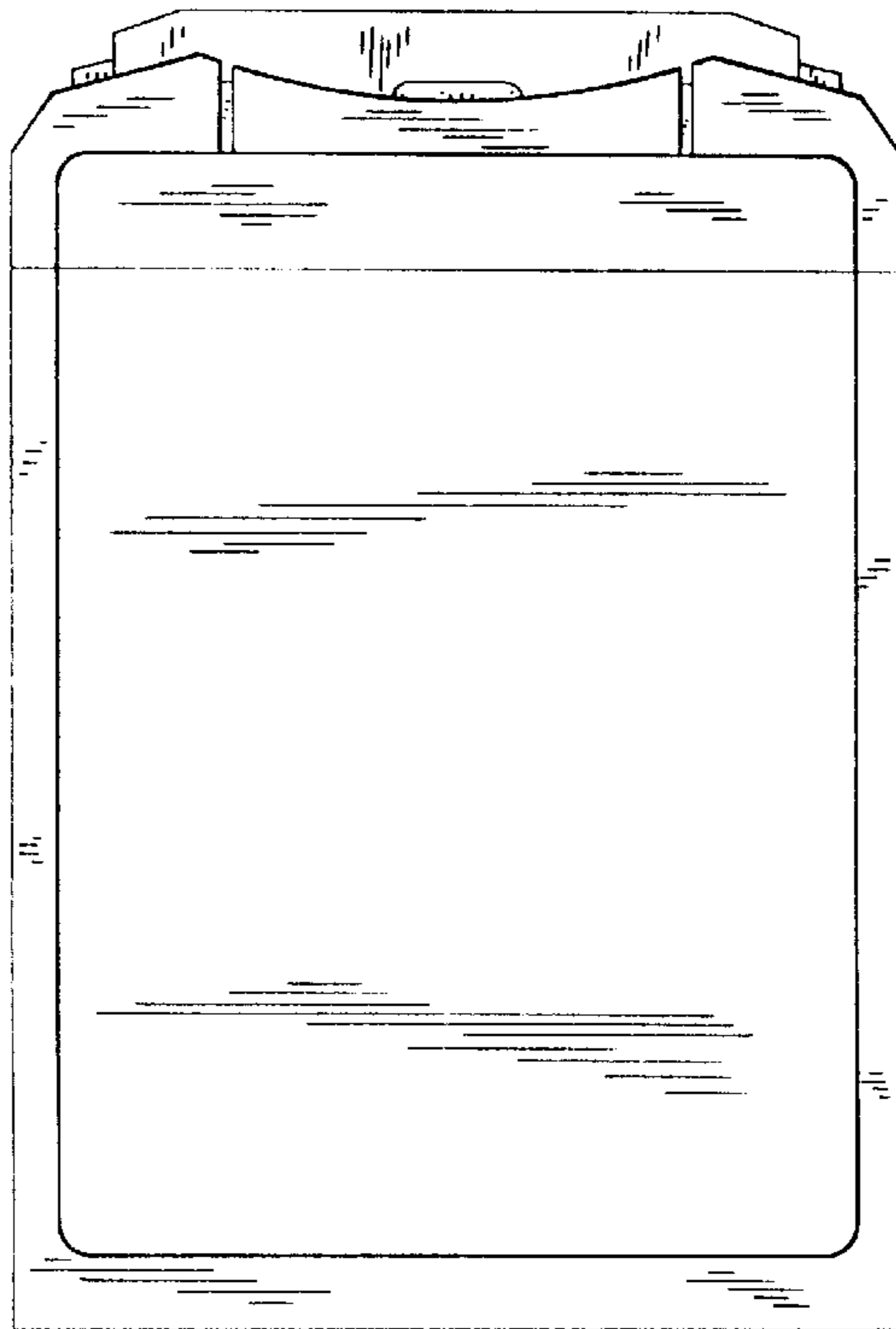

FIG. 6

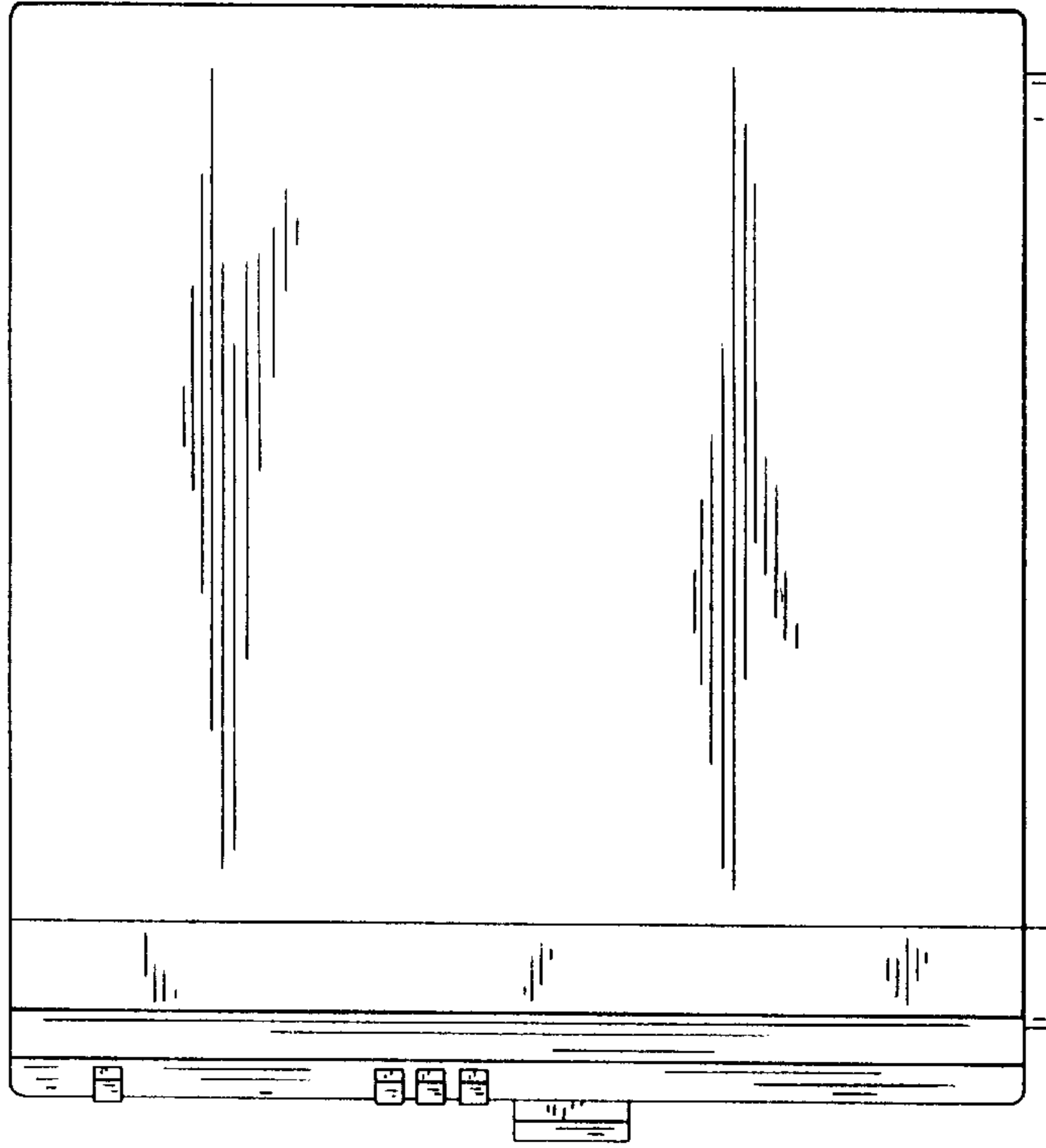

FIG. 3

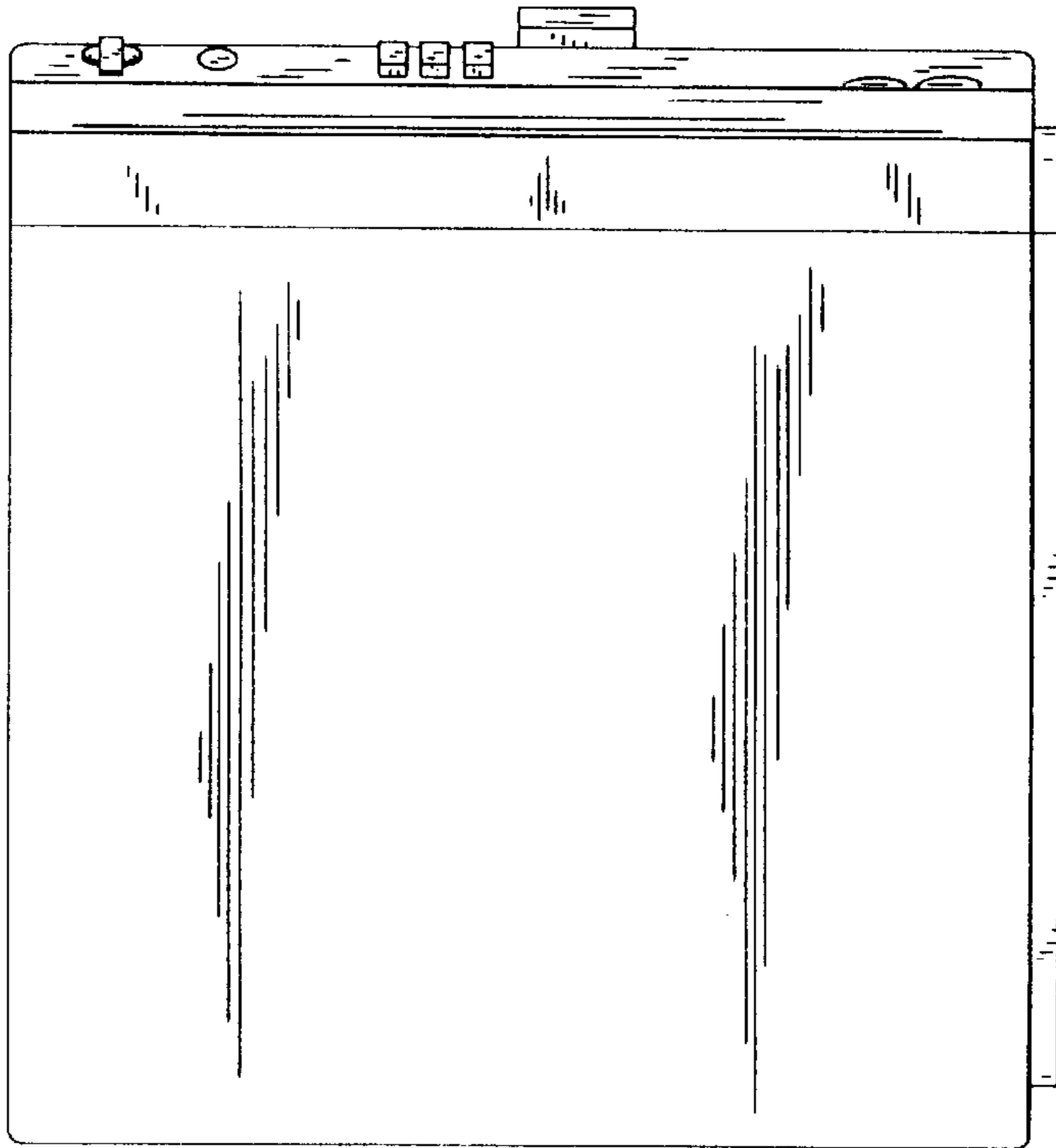

FIG. 7

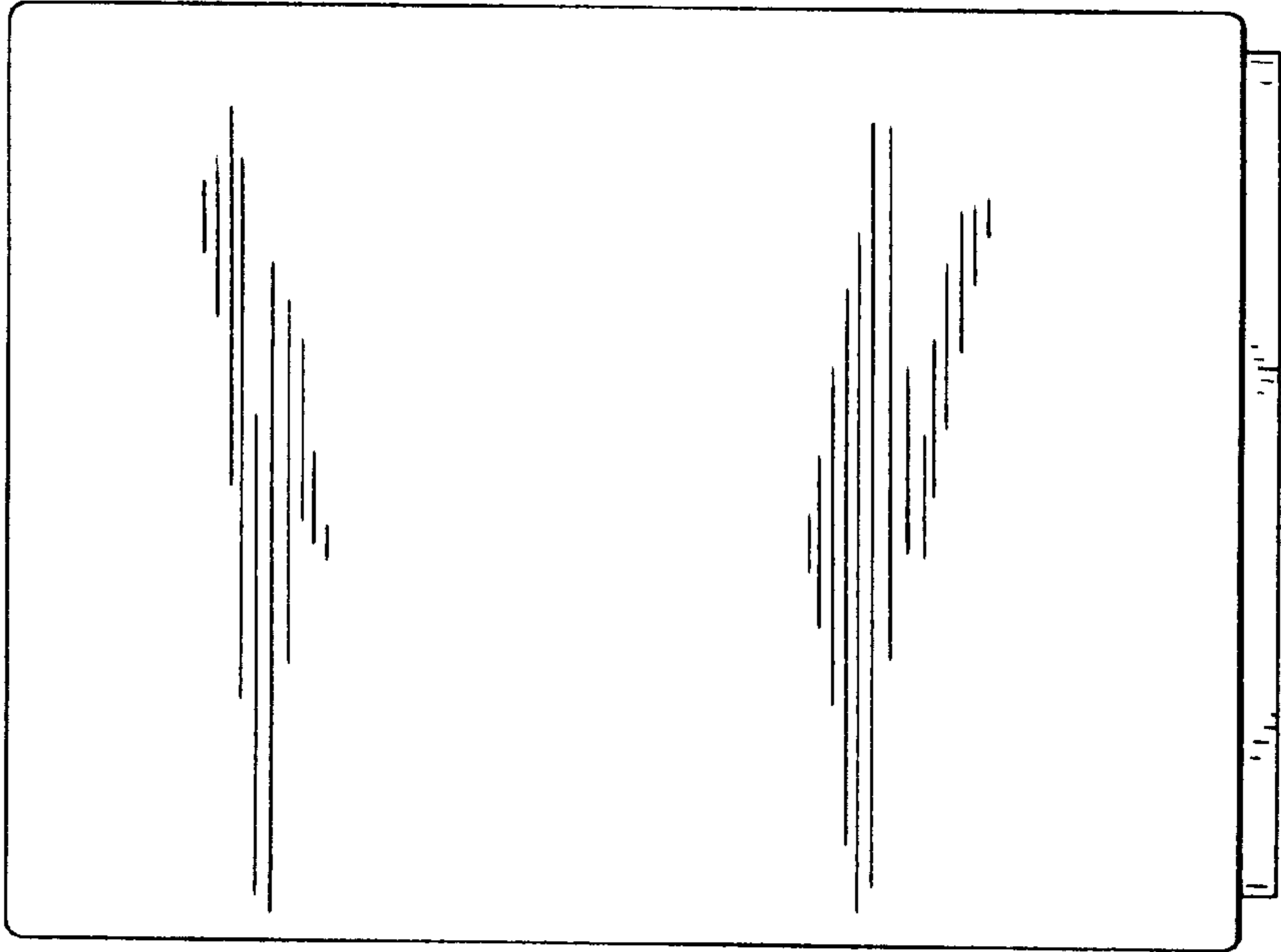

FIG. 4

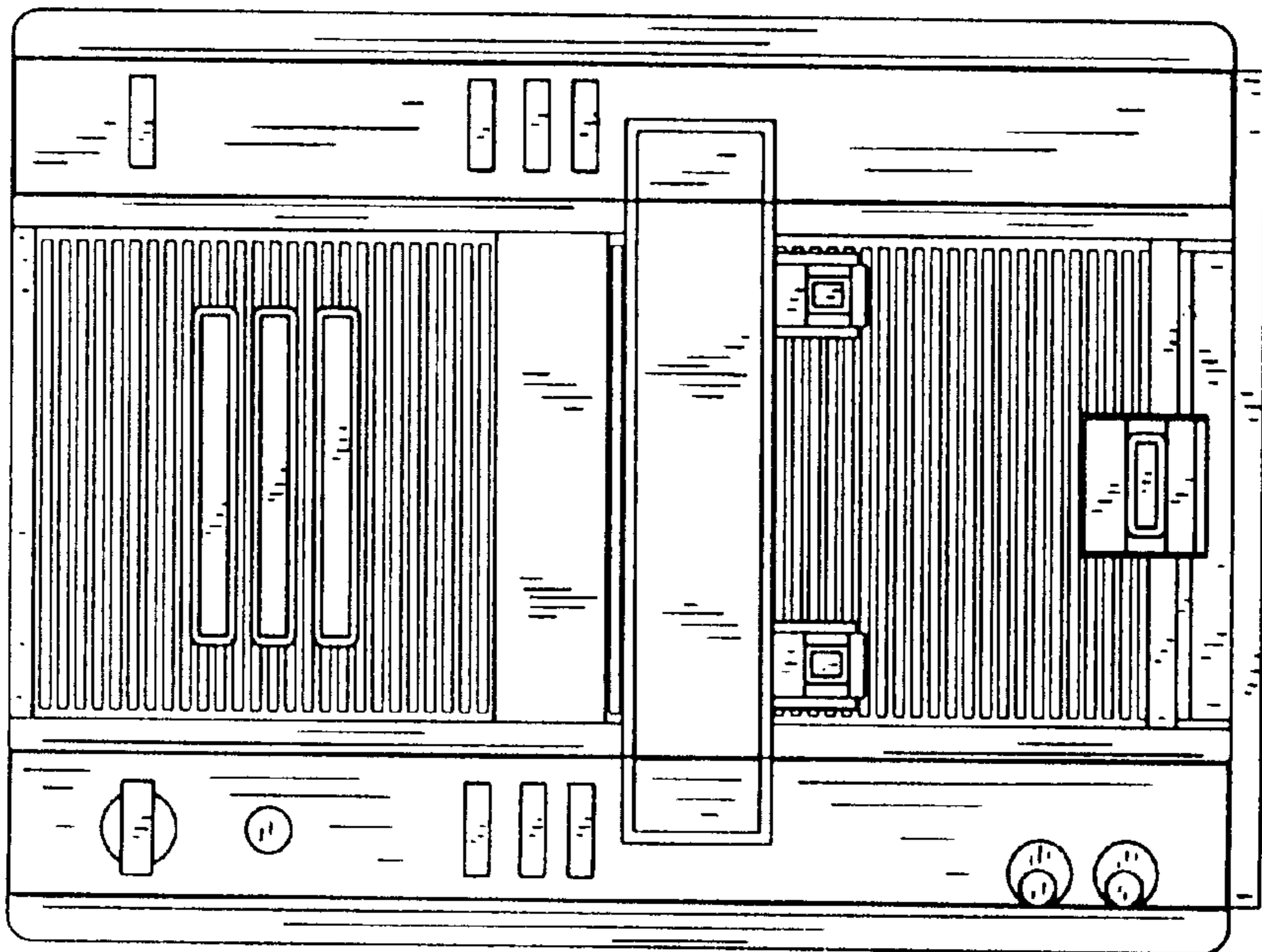

FIG. 8

