



US00D420959S

United States Patent [19] Sousamian

[11] **Patent Number: Des. 420,959**

[45] **Date of Patent: ** Feb. 22, 2000**

[54] **VEHICLE GRILLE COVER**

[75] Inventor: **Timothy W. Sousamian**, Whittier, Calif.

[73] Assignee: **Performance Marketing, Inc.**, Garden Grove, Calif.

[**] Term: **14 Years**

[21] Appl. No.: **29/095,724**

[22] Filed: **Oct. 29, 1998**

[51] **LOC (7) Cl.** **12-16**

[52] **U.S. Cl.** **D12/163**

[58] **Field of Search** D12/163, 171;
293/115, 117, 120; 180/68.6

[56] **References Cited**

U.S. PATENT DOCUMENTS

D. 286,999	12/1986	Hiranka	D12/163
D. 290,830	7/1987	Inada	D12/163
D. 293,230	12/1987	Kawaoki	D12/163
D. 318,835	8/1991	Partin	D12/169

OTHER PUBLICATIONS

Trader's 1997 Accessories Catalog #9, Dec. 26, 1996, front cover.

Sport Truck magazine, Jul. 3, 1997, front cover.

Primary Examiner—Melody N. Brown
Attorney, Agent, or Firm—Lyon & Lyon LLP

[57] **CLAIM**

The ornamental design for a vehicle grille cover, as shown and described.

DESCRIPTION

FIG. 1 is a perspective view of a vehicle grille cover embodying my new design, the front perspective of a vehicle being shown fragmentally to show the environment in which the vehicle grille cover is used, the broken lines being for illustrative purposes only, and forming no part of the claimed design.

FIG. 2 is a perspective view of a portion of the vehicle grille cover which is the upper portion as seen in FIG. 1, the lower portion as seen in FIG. 1 being identical to the upper portion but for the orientation in the assembled vehicle grille cover. FIG. 3 is a front elevational view of the upper portion of the vehicle grille cover.

FIG. 4 is a right side view of the upper portion of the vehicle grille cover, the left side view being a mirror image thereof. FIG. 5 is a top plan view of the upper portion of the vehicle grille cover.

FIG. 6 is a rear elevational view of the upper portion of the vehicle grille cover; and,

FIG. 7 is a bottom plan view of the upper portion of the vehicle grille cover.

1 Claim, 2 Drawing Sheets

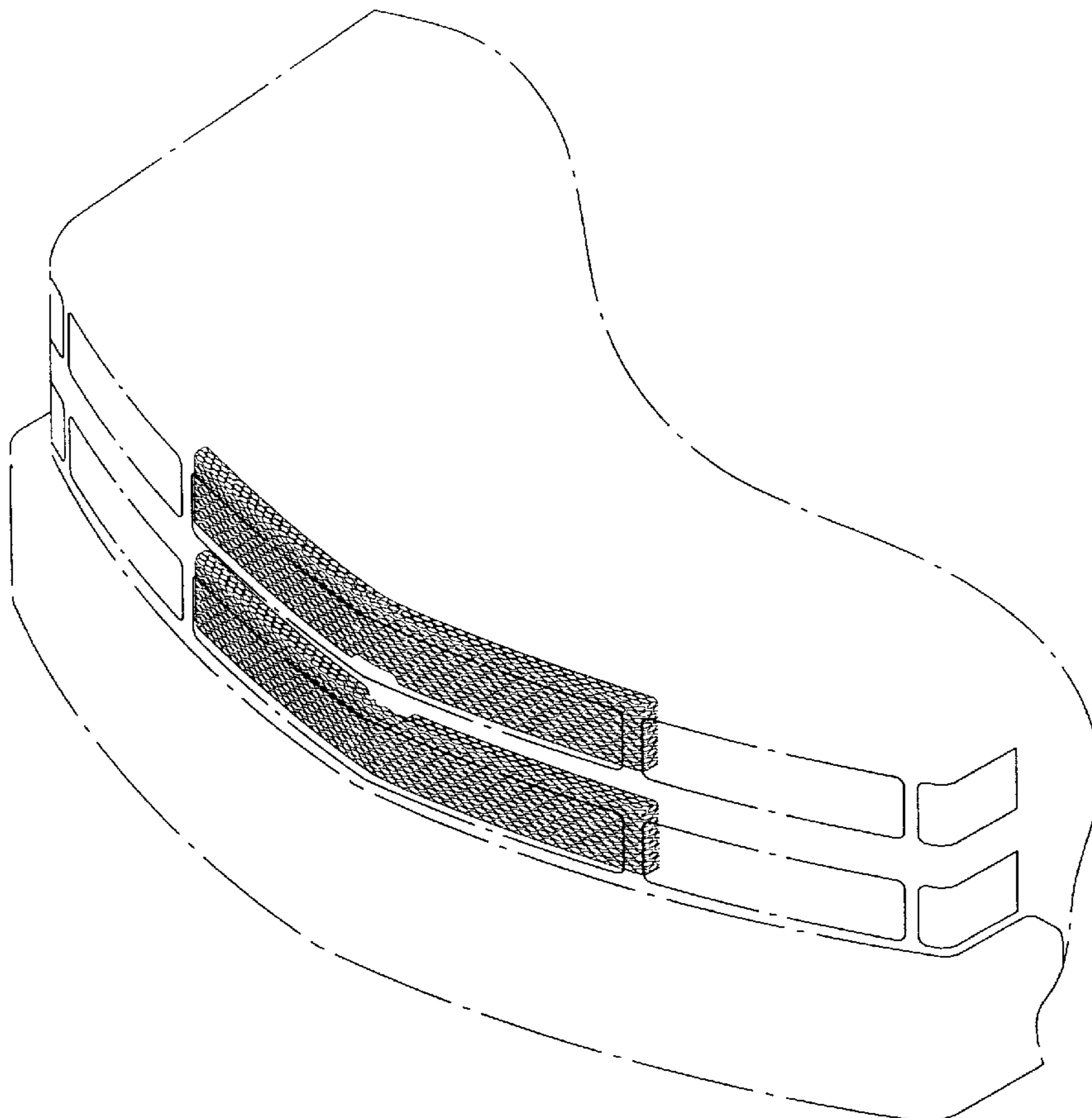

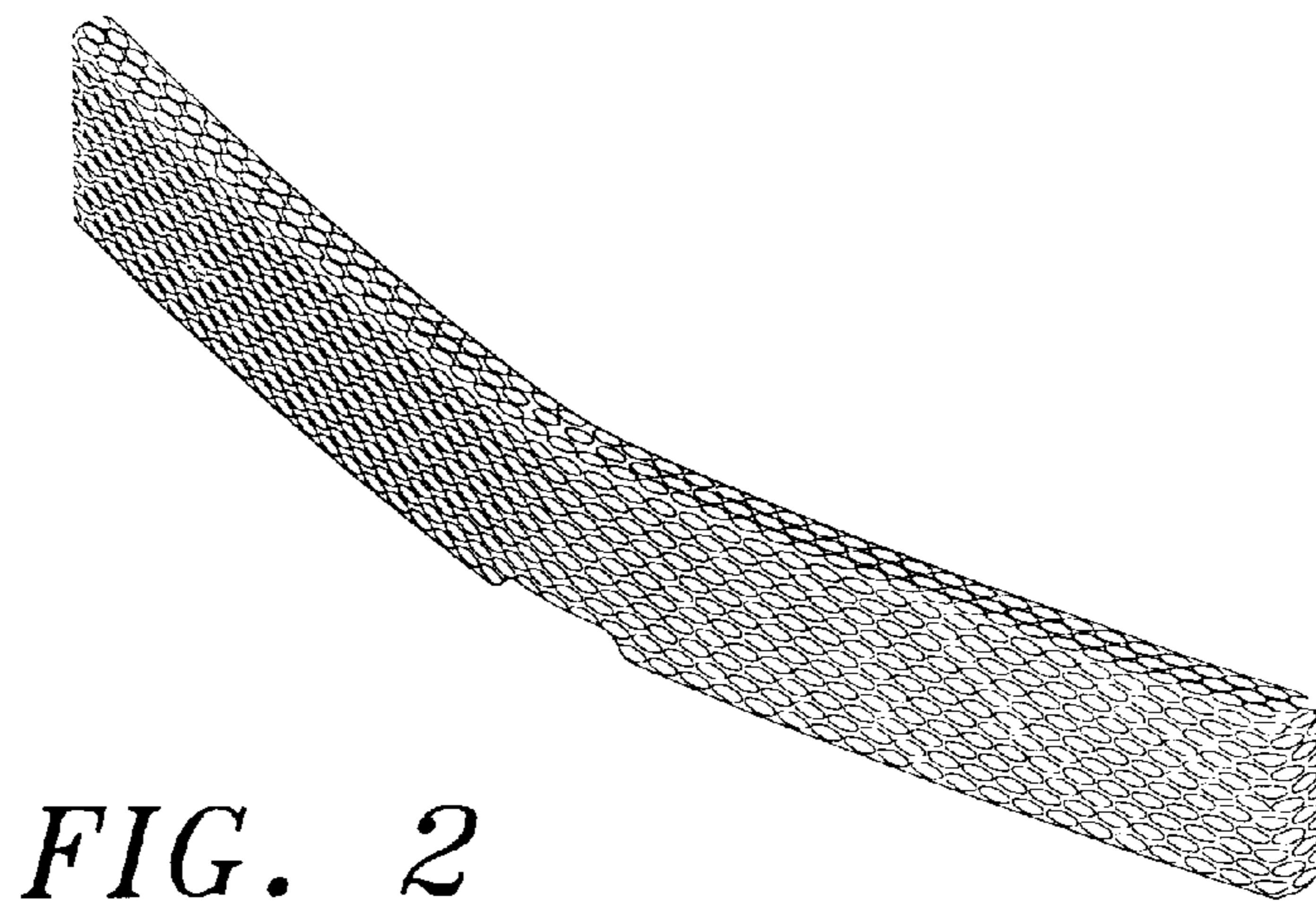
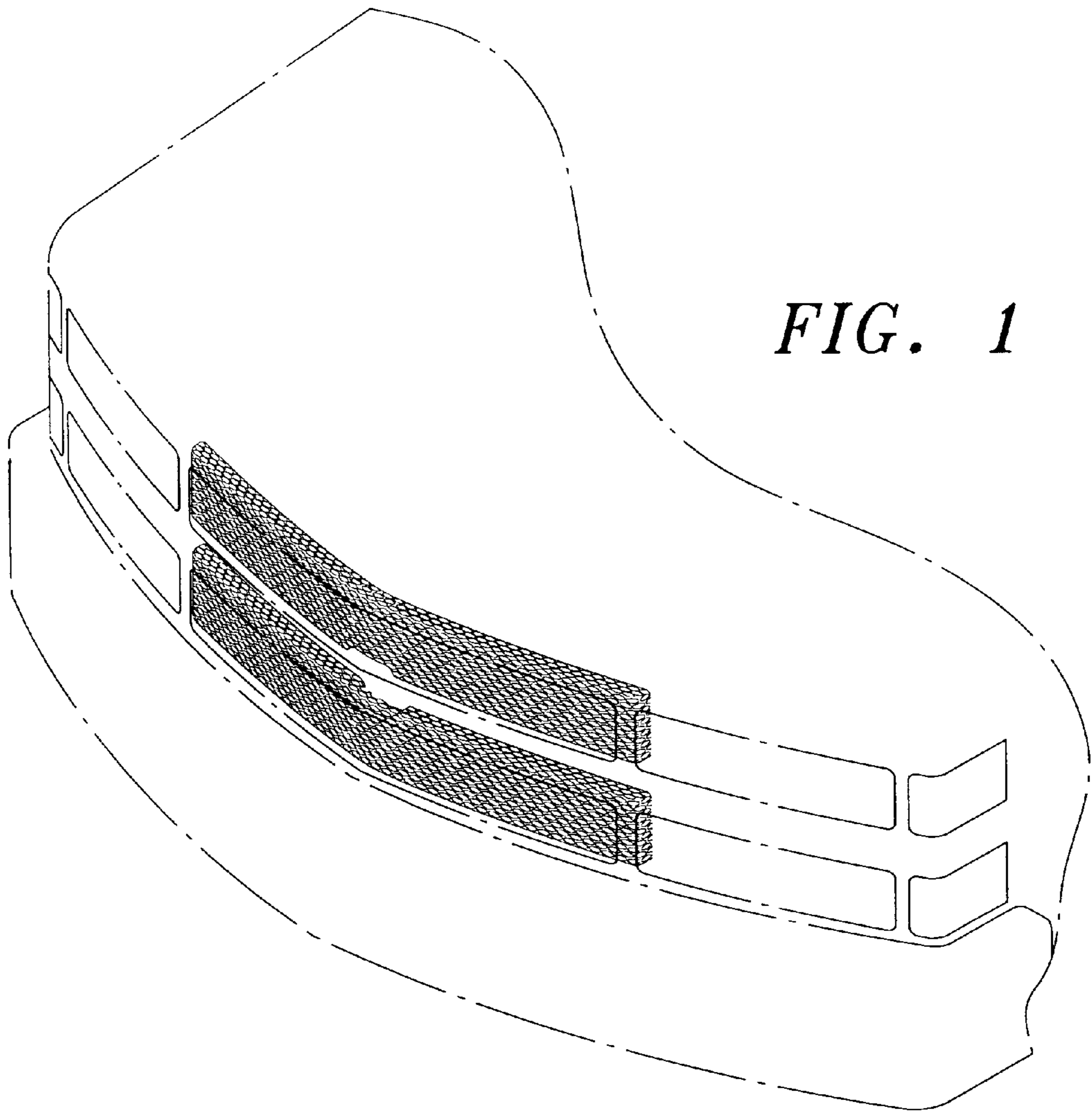

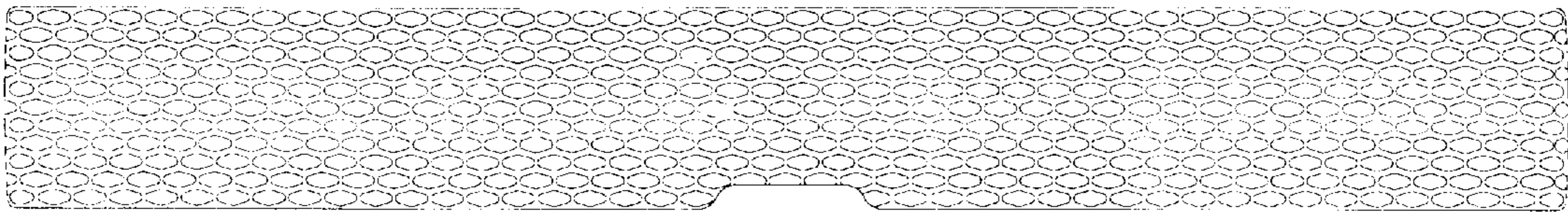

FIG. 3

FIG. 4

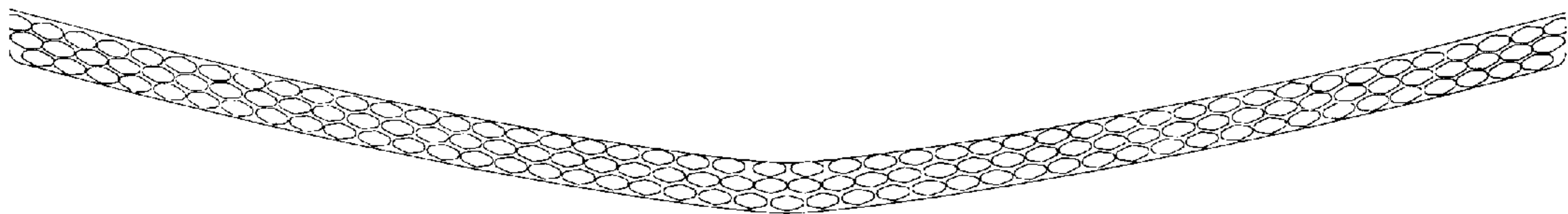
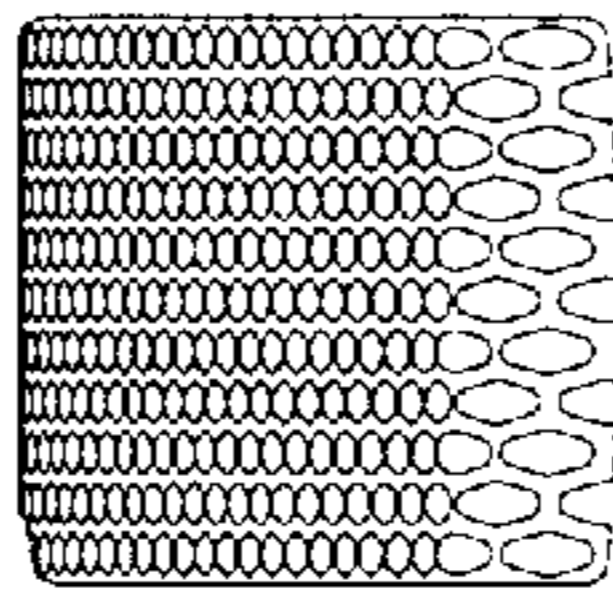

FIG. 5

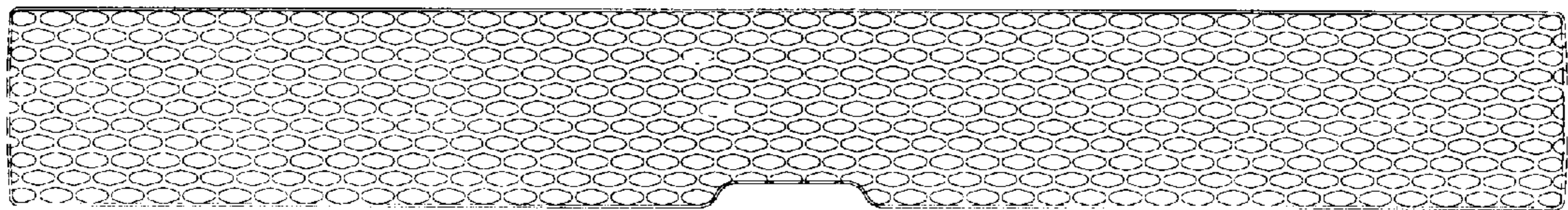

FIG. 6



FIG. 7