



US00D420922S

**United States Patent** [19]  
**Gueit**

[11] **Patent Number: Des. 420,922**

[45] **Date of Patent: \*\* Feb. 22, 2000**

[54] **WATCH WITH BRACELET**

2,293,940 8/1942 Jahr et al. .  
3,780,918 12/1973 Curtis ..... 224/165

[75] Inventor: **Jean-Claude Gueit**, Perly, Switzerland

*Primary Examiner*—Nelson C. Holtje  
*Attorney, Agent, or Firm*—Young & Thompson

[73] Assignee: **S.A. Ancienne Fabrique Georges Piaget & Cie**, La Cote-Aux-Fees, Switzerland

[57] **CLAIM**

[\*\*] Term: **14 Years**

The ornamental design for watch with bracelet, as shown and described.

[21] Appl. No.: **29/107,046**

**DESCRIPTION**

[22] Filed: **Jun. 29, 1999**

FIG. 1 is a perspective view of a first embodiment thereof.  
FIG. 2 is a top view of a first embodiment thereof.  
FIG. 3 is a bottom view of a first embodiment thereof.  
FIG. 4 is a side view from the right of FIG. 2.  
FIG. 5 is a side view from the left of FIG. 2.  
FIG. 6 is a view from the top of FIG. 2.  
FIG. 7 is a view from the bottom of FIG. 2.  
FIG. 8 is a perspective view of a second embodiment thereof.  
FIG. 9 is a top view of a second embodiment thereof.  
FIG. 10 is a bottom view of a second embodiment thereof.  
FIG. 11 is a side view from the right of FIG. 9.  
FIG. 12 is a side view from the left of FIG. 9.  
FIG. 13 is a view from the top of FIG. 9; and,  
FIG. 14 is a view from the bottom of FIG. 9.

[30] **Foreign Application Priority Data**

Jan. 28, 1999 [XH] Hague Agreement ..... DMA/004373

[51] **LOC (7) Cl.** ..... **10-02**

[52] **U.S. Cl.** ..... **D10/32**

[58] **Field of Search** ..... D10/1-40, 122-132;  
D11/3-25; 63/1.1, 3, 5, 11; 368/276-277,  
280-282, 285

[56] **References Cited**

**U.S. PATENT DOCUMENTS**

- D. 180,083 4/1957 Jedwabnick ..... D10/30
- D. 302,663 8/1989 Basckin ..... D10/32
- D. 402,567 12/1998 Gueit ..... D10/32

**1 Claim, 4 Drawing Sheets**

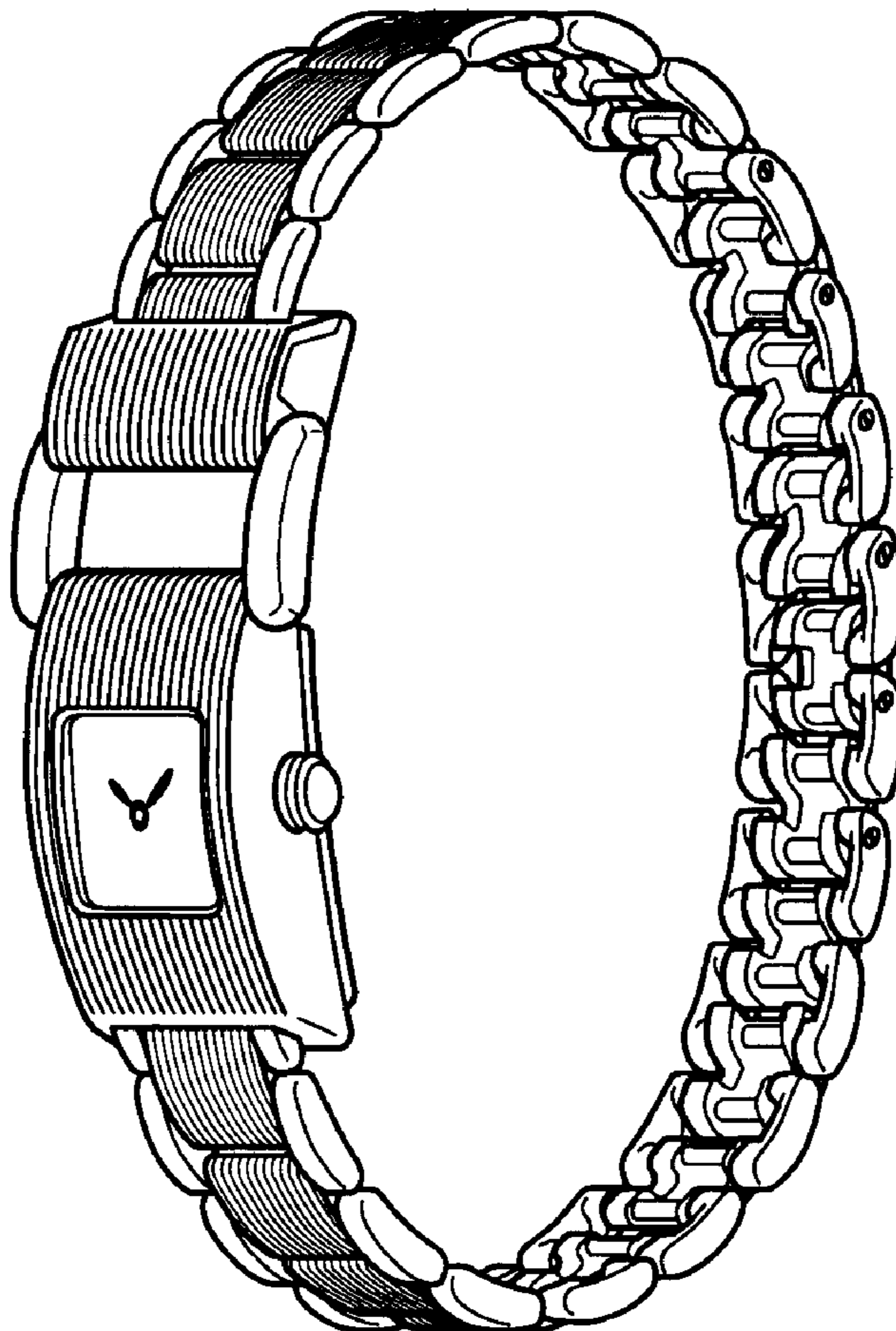

Fig 1

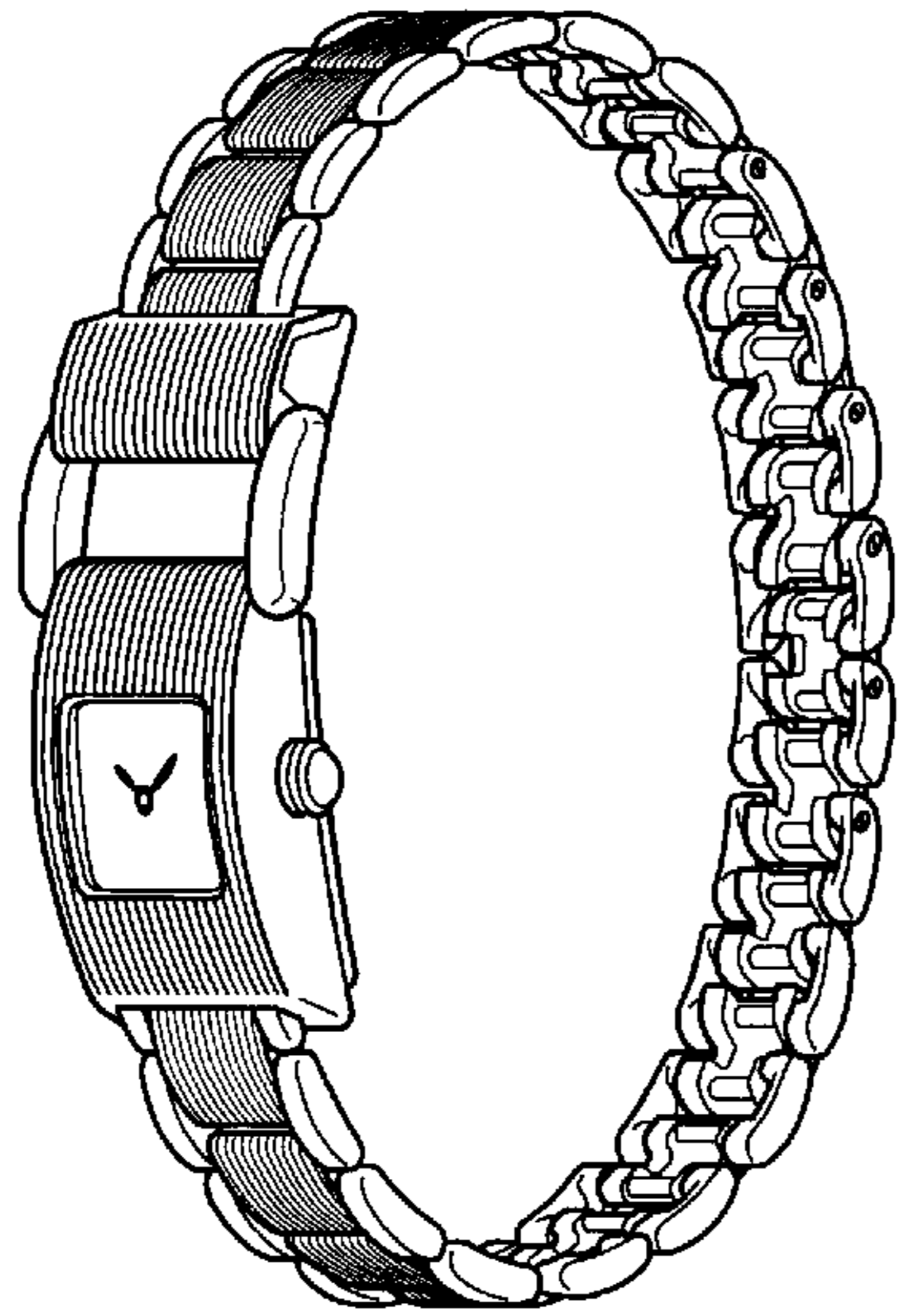

Fig 4

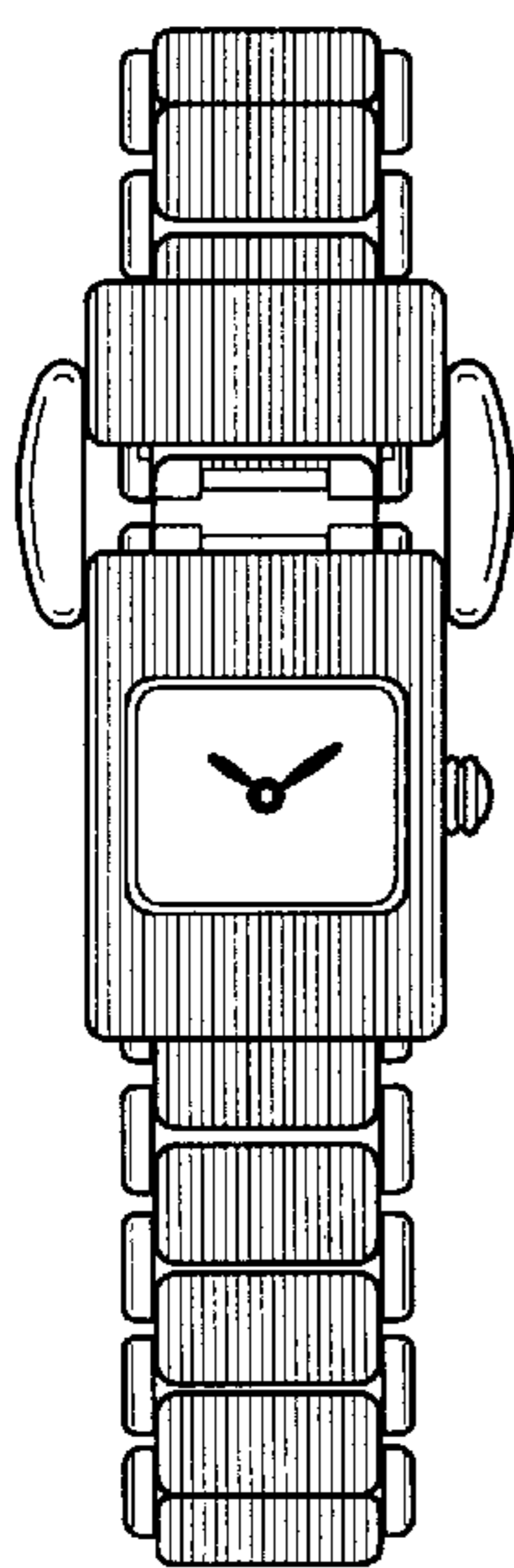
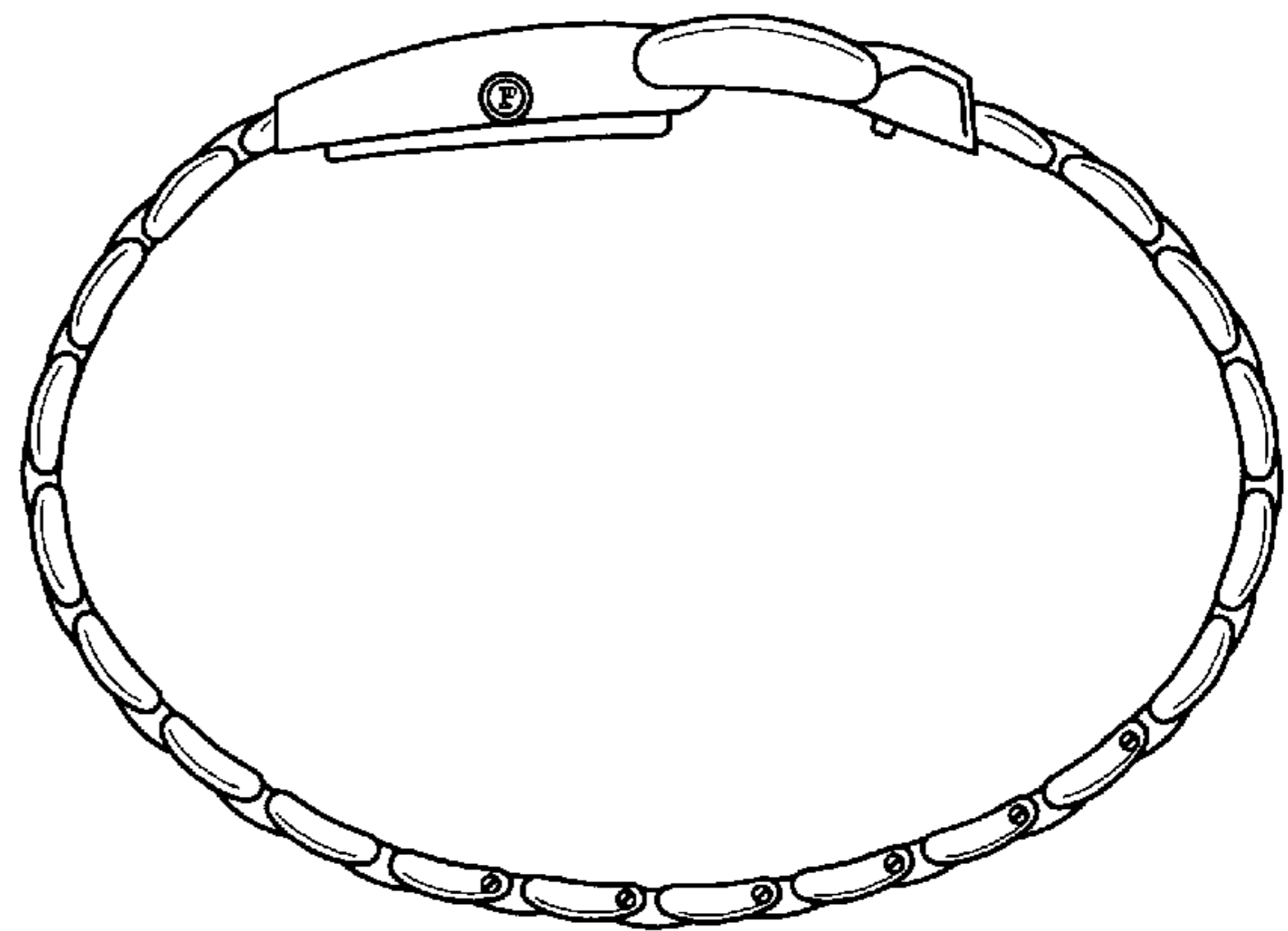

Fig 2

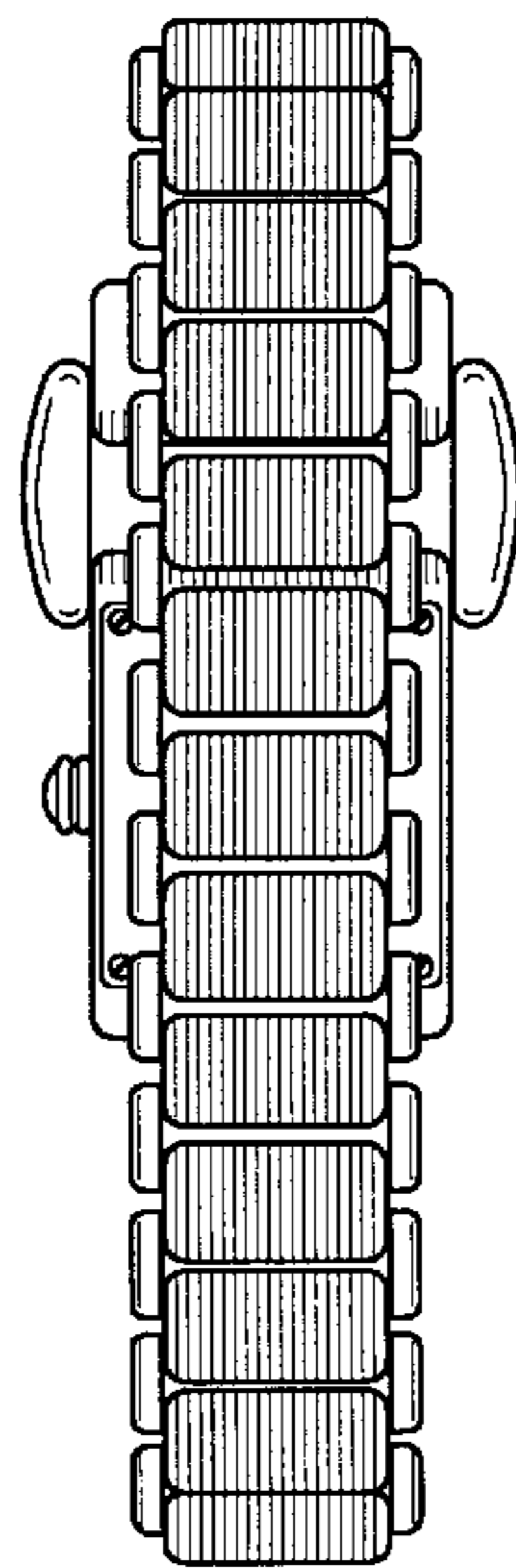

Fig 3

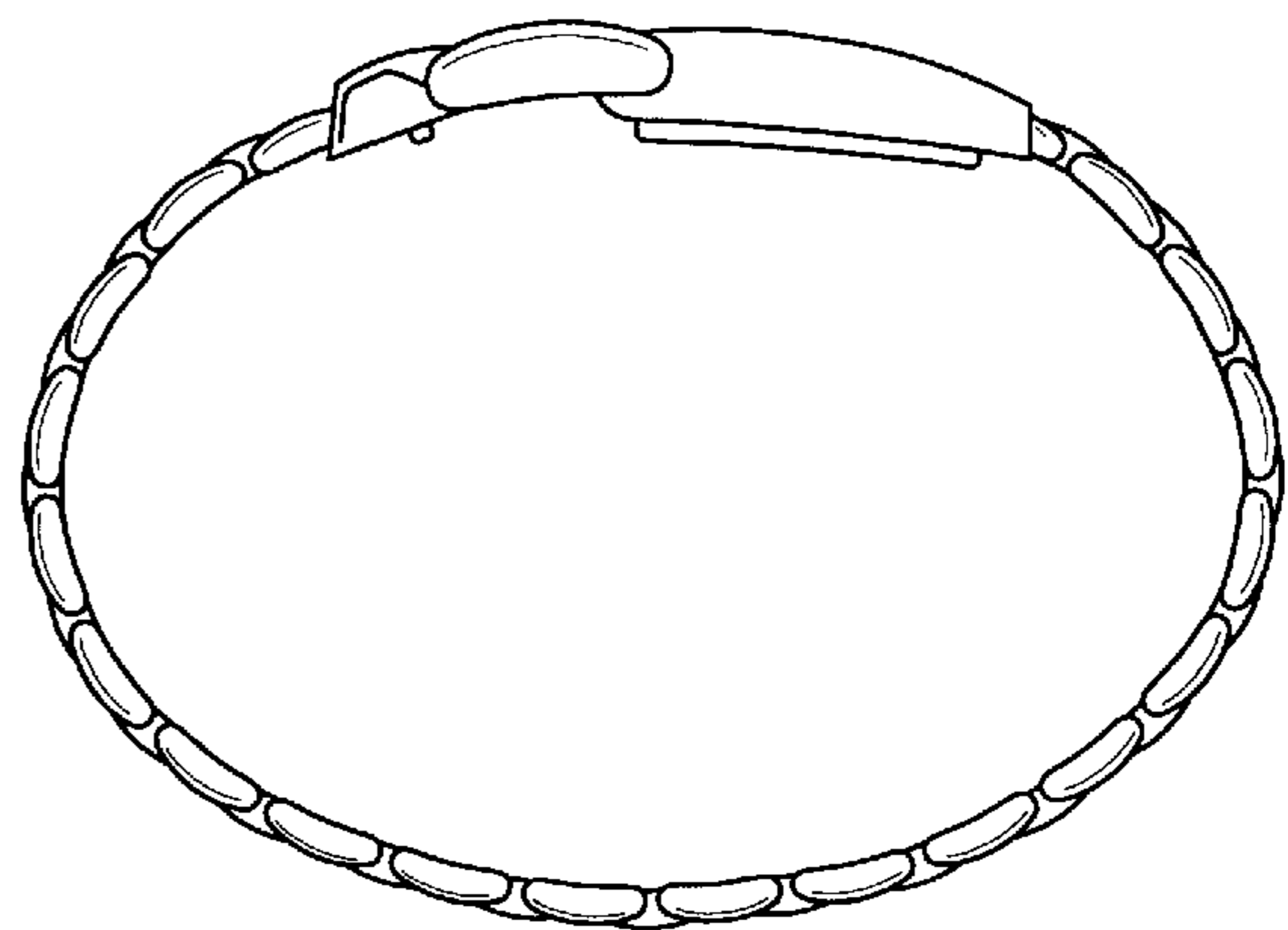

Fig 5

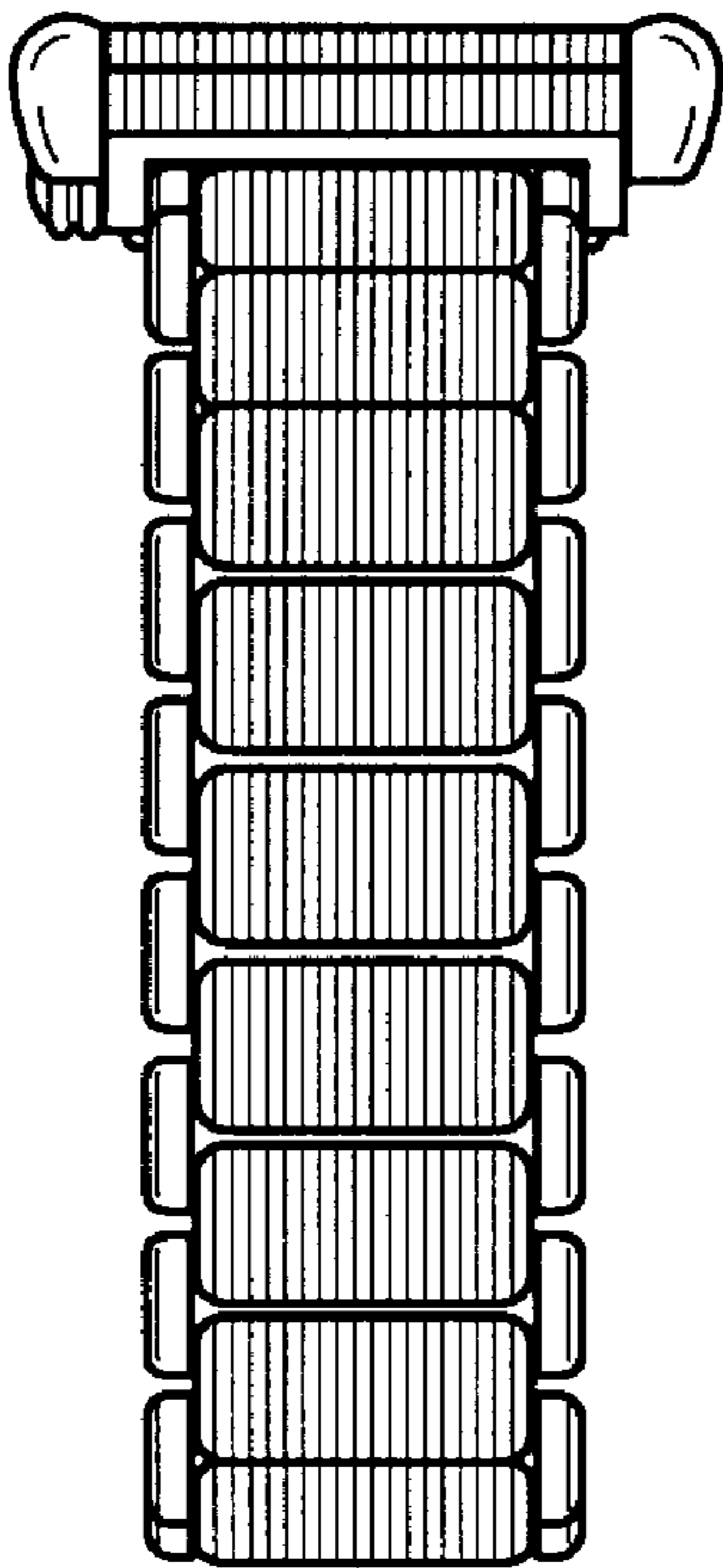

Fig 6

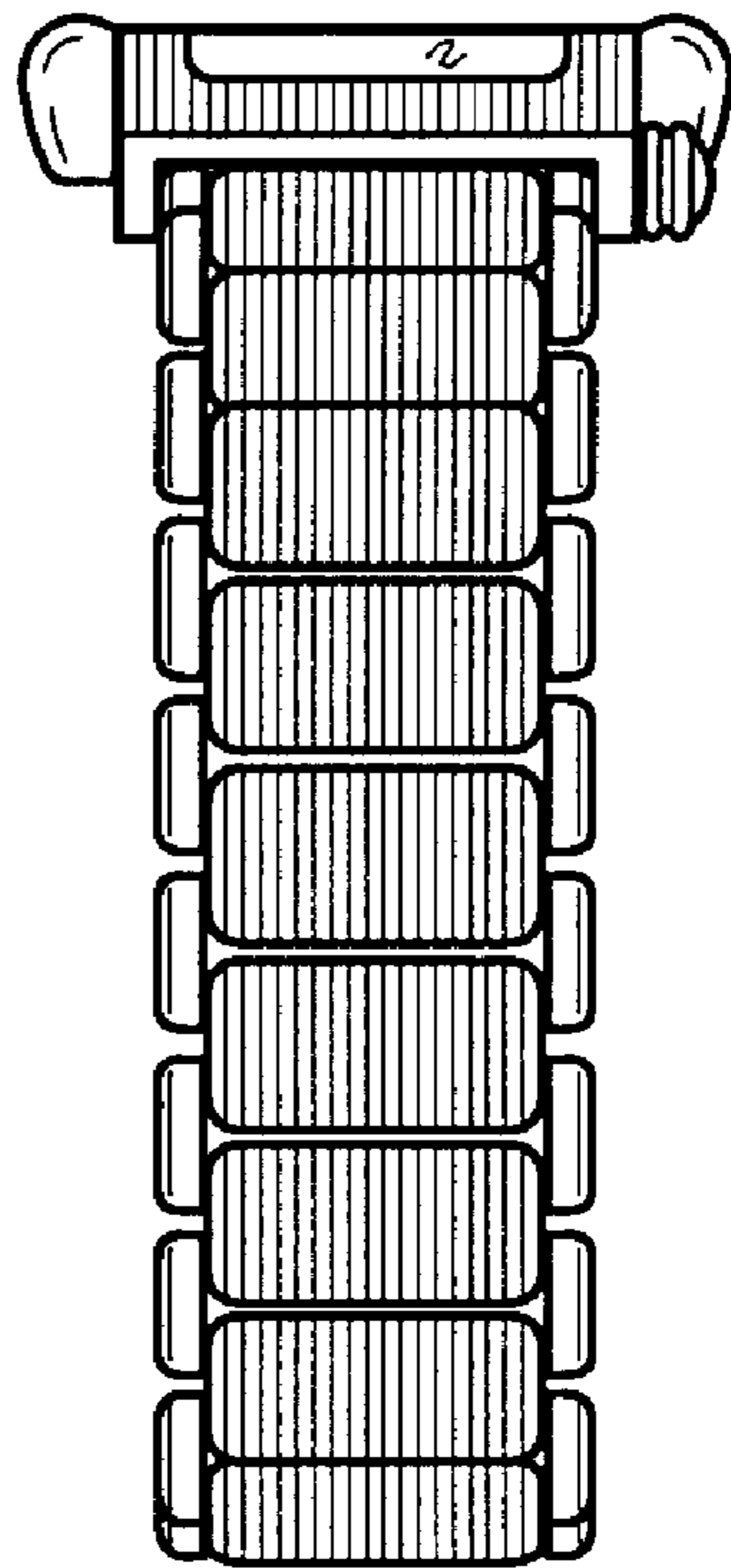

Fig 7

Fig 8

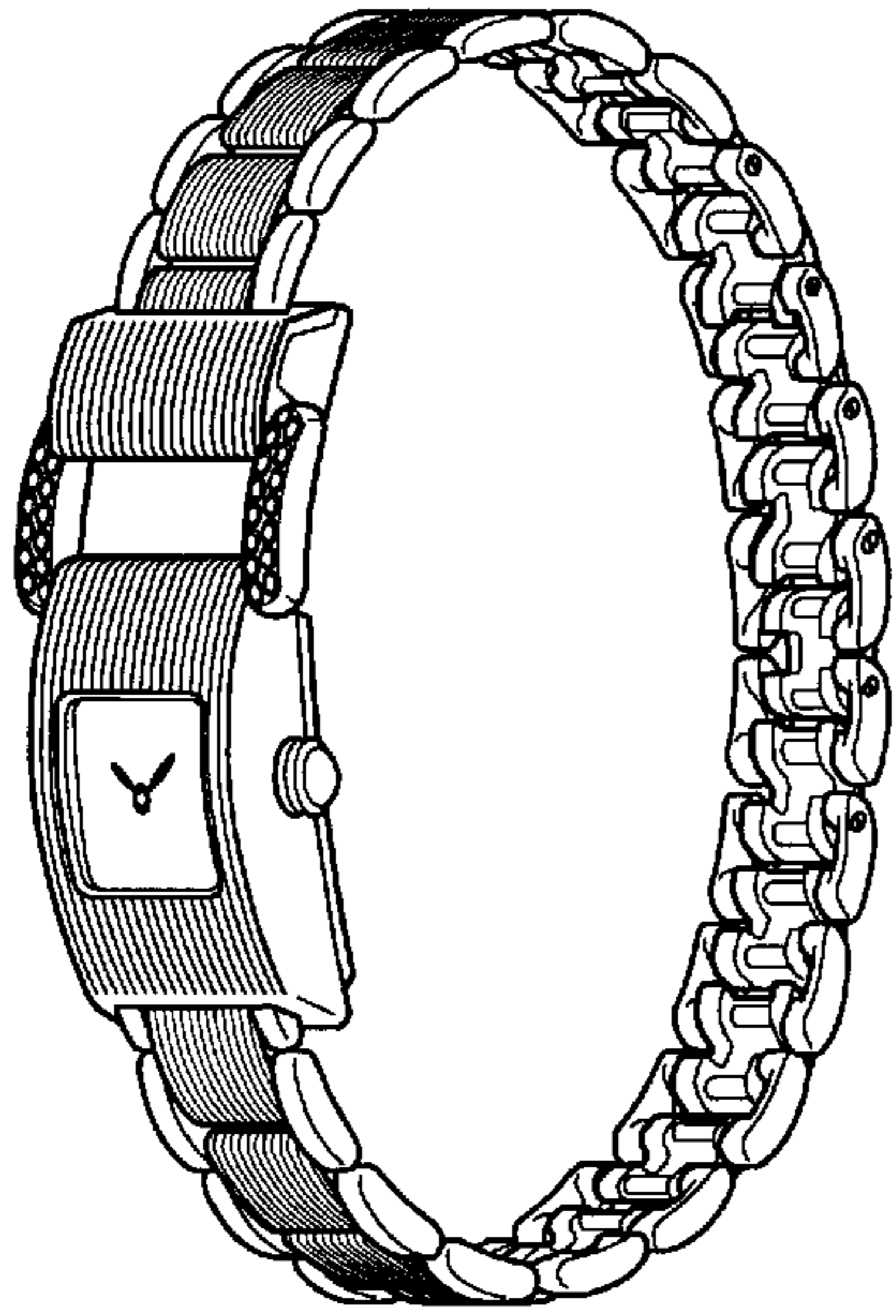

Fig 11

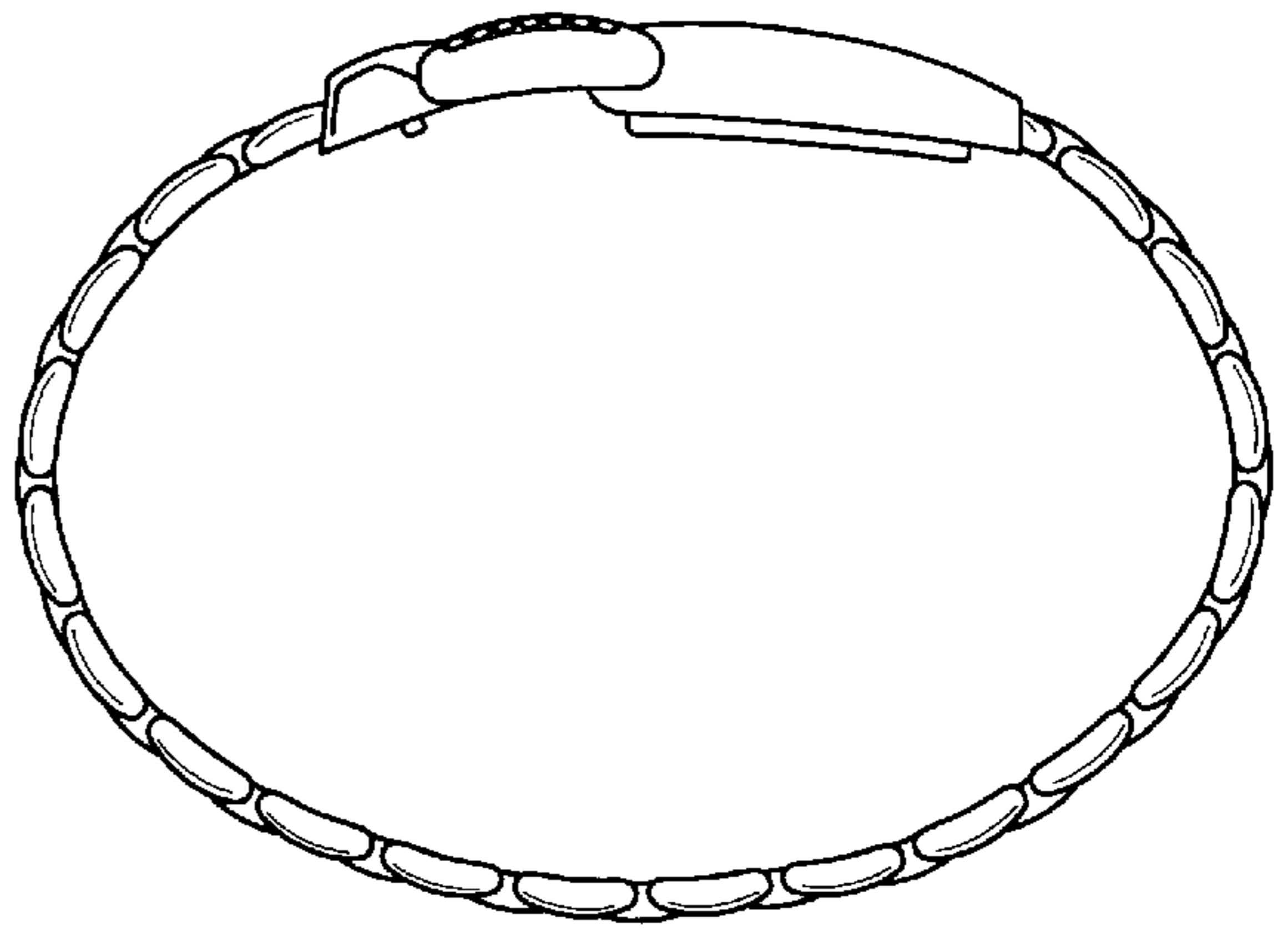
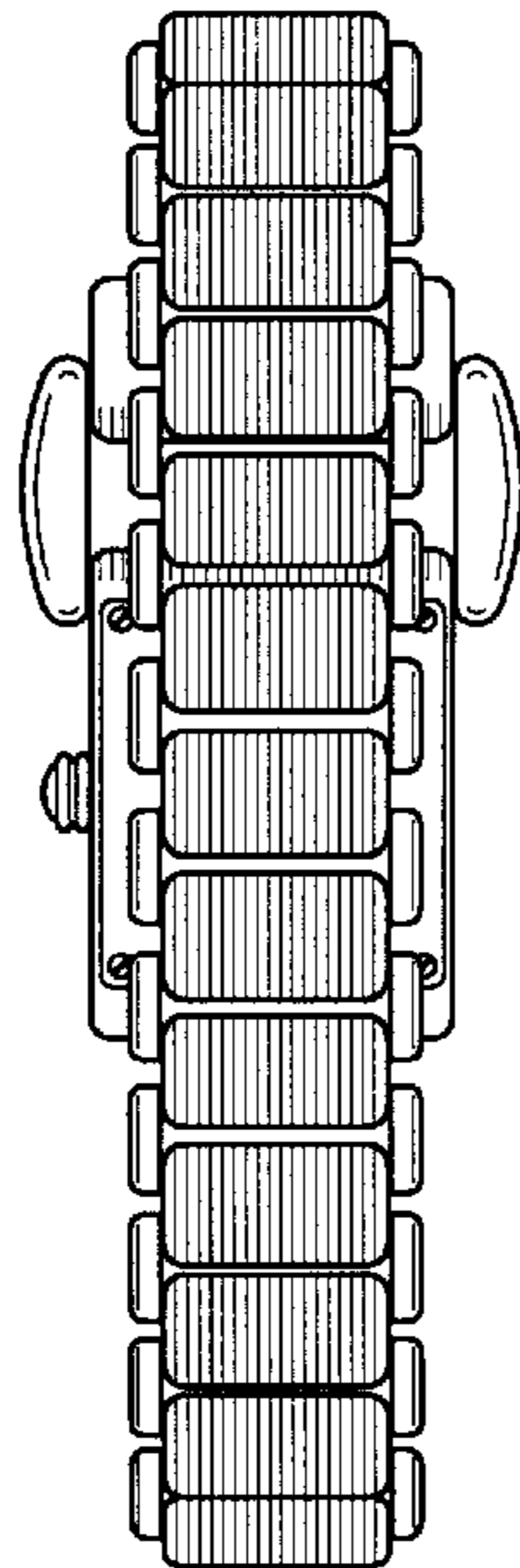
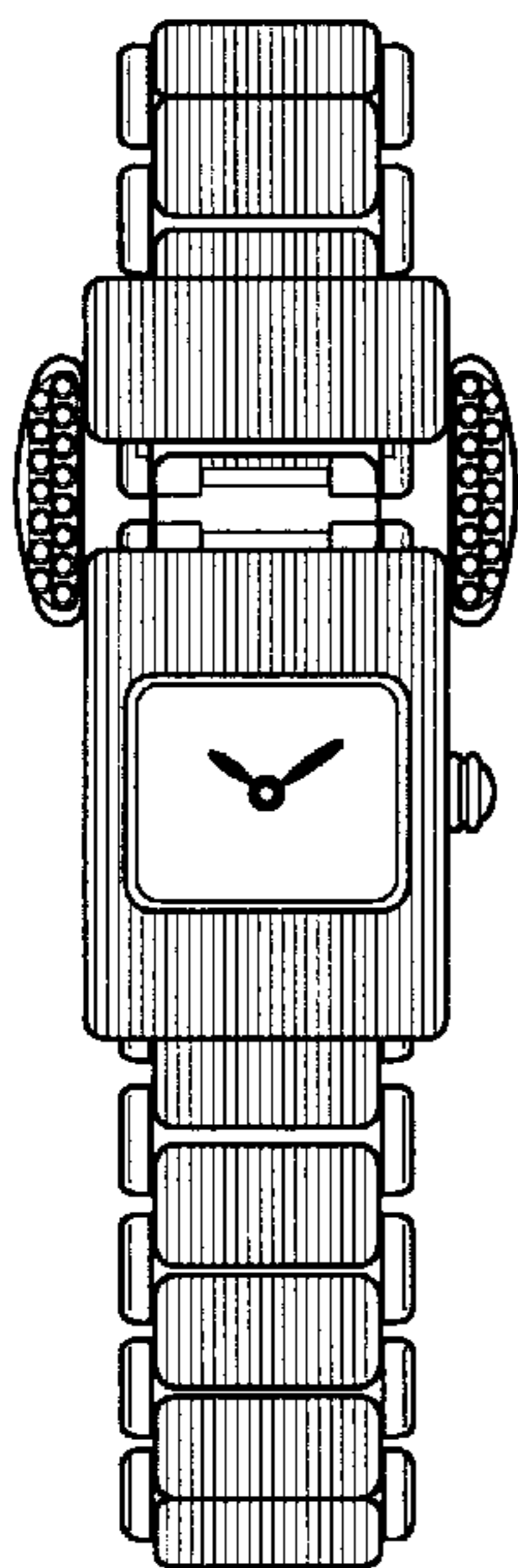
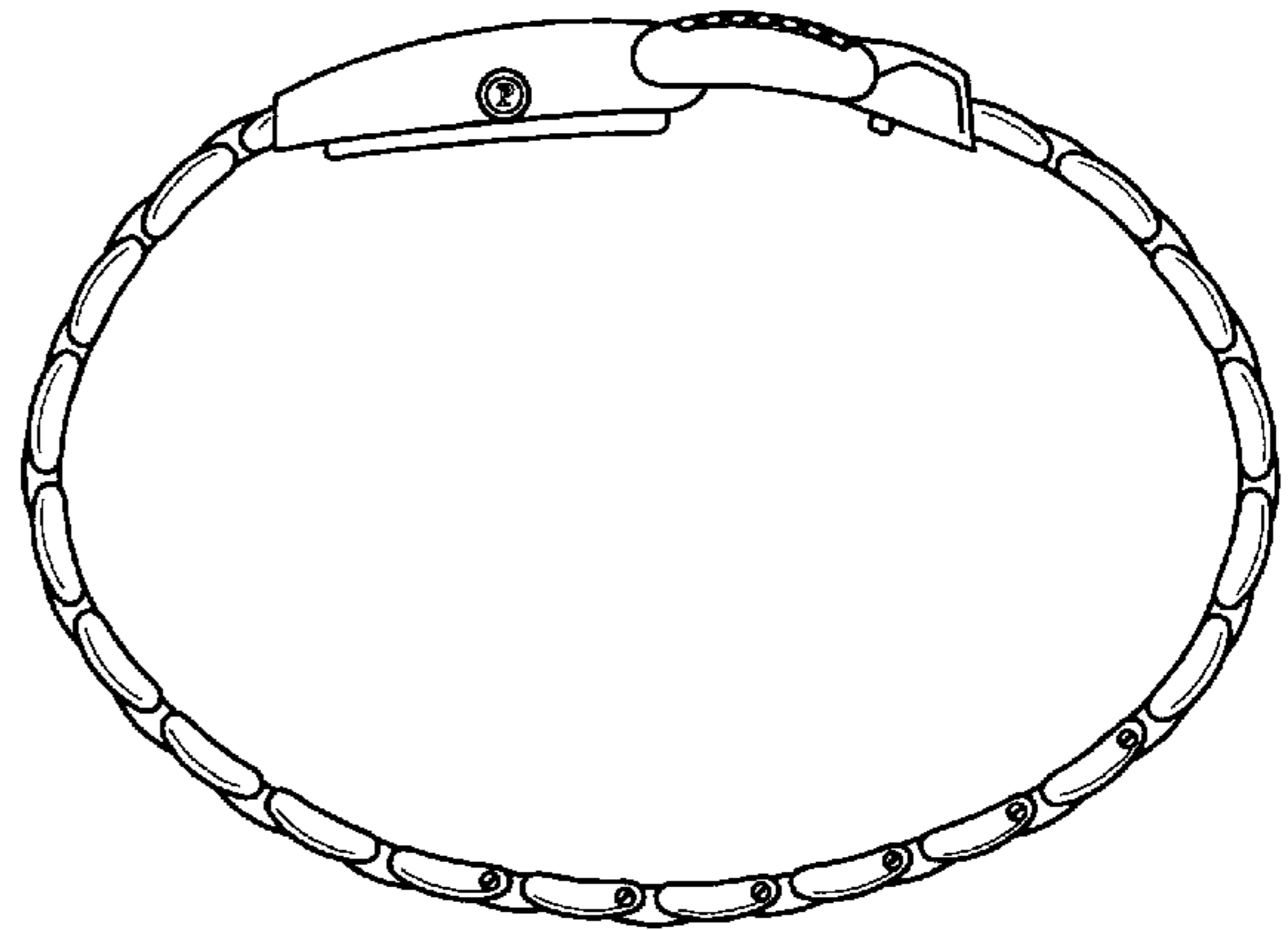

Fig 9

Fig 10

Fig 12

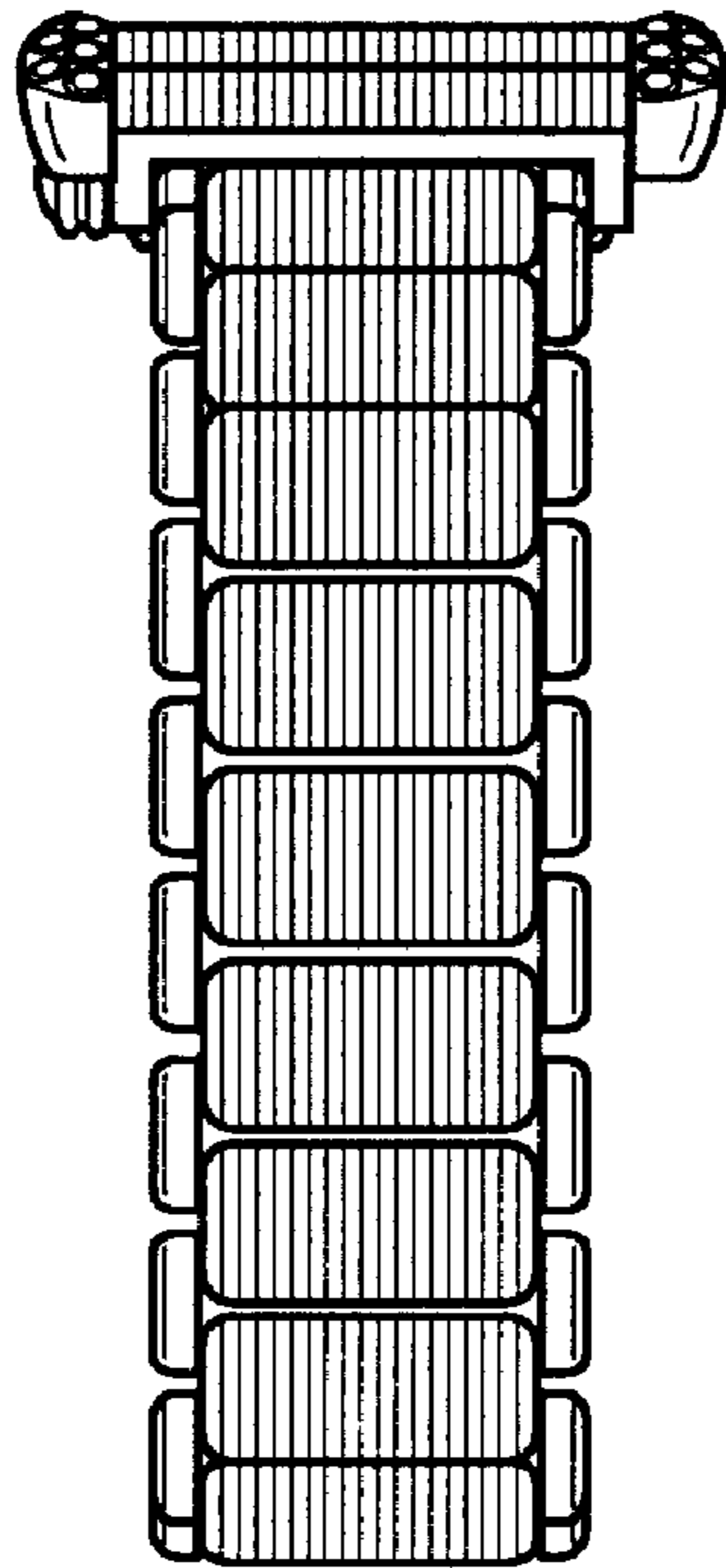

Fig 13

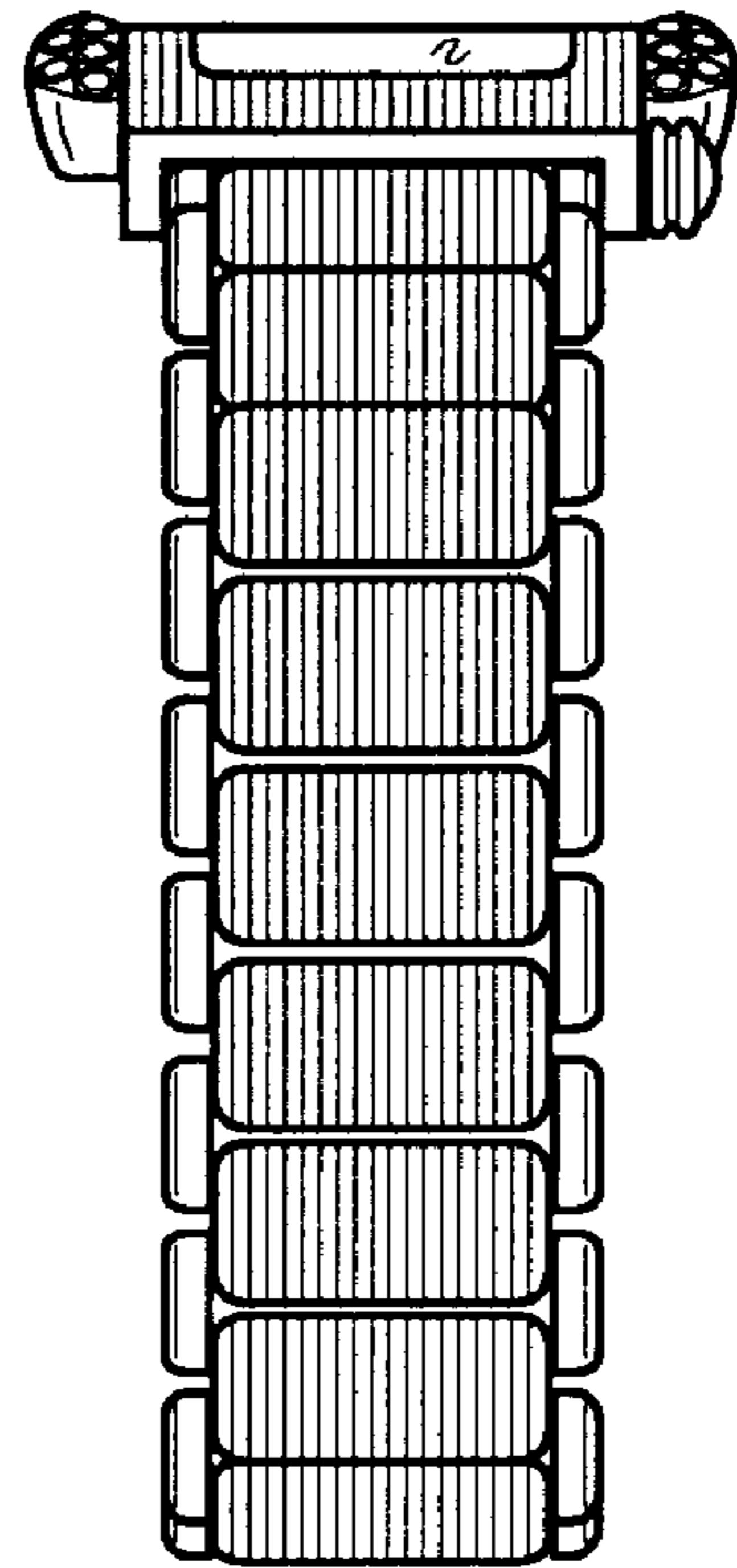

Fig 14