



US00D420899S

# United States Patent [19] Jubar

[11] **Patent Number: Des. 420,899**

[45] **Date of Patent: \*\* Feb. 22, 2000**

[54] **TRASH BAG WITH ADHESIVE RETAINING MEANS**

[76] Inventor: **Faydi O Jubar**, 640 E. Armour #903, Kansas City, Mo. 64109

[\*\*] Term: **14 Years**

[21] Appl. No.: **29/097,739**

[22] Filed: **Dec. 11, 1998**

[51] **LOC (7) Cl.** ..... **09-05**

[52] **U.S. Cl.** ..... **D9/305**

[58] **Field of Search** ..... D9/305, 306; 229/87.01; 383/5, 11, 38, 71, 84, 88, 89, 93, 95, 205, 210, 211

[56] **References Cited**

**U.S. PATENT DOCUMENTS**

D. 402,543	12/1998	Thieman	.....	D9/305
3,625,270	12/1971	Skendzic	.....	383/205
3,686,060	8/1972	Gurtler	.....	229/87.01 X
4,335,769	6/1982	McManus	.....	383/11
4,464,158	8/1984	Kardon	.....	383/5 X
4,988,547	1/1991	Voto, Jr. et al.	.....	383/84 X
5,273,361	12/1993	Jillson	.....	383/84 X
5,380,093	1/1995	Goldman	.....	383/38

5,407,419 4/1995 Kelly et al. .... 383/71 X

*Primary Examiner*—Cathron B. Matta

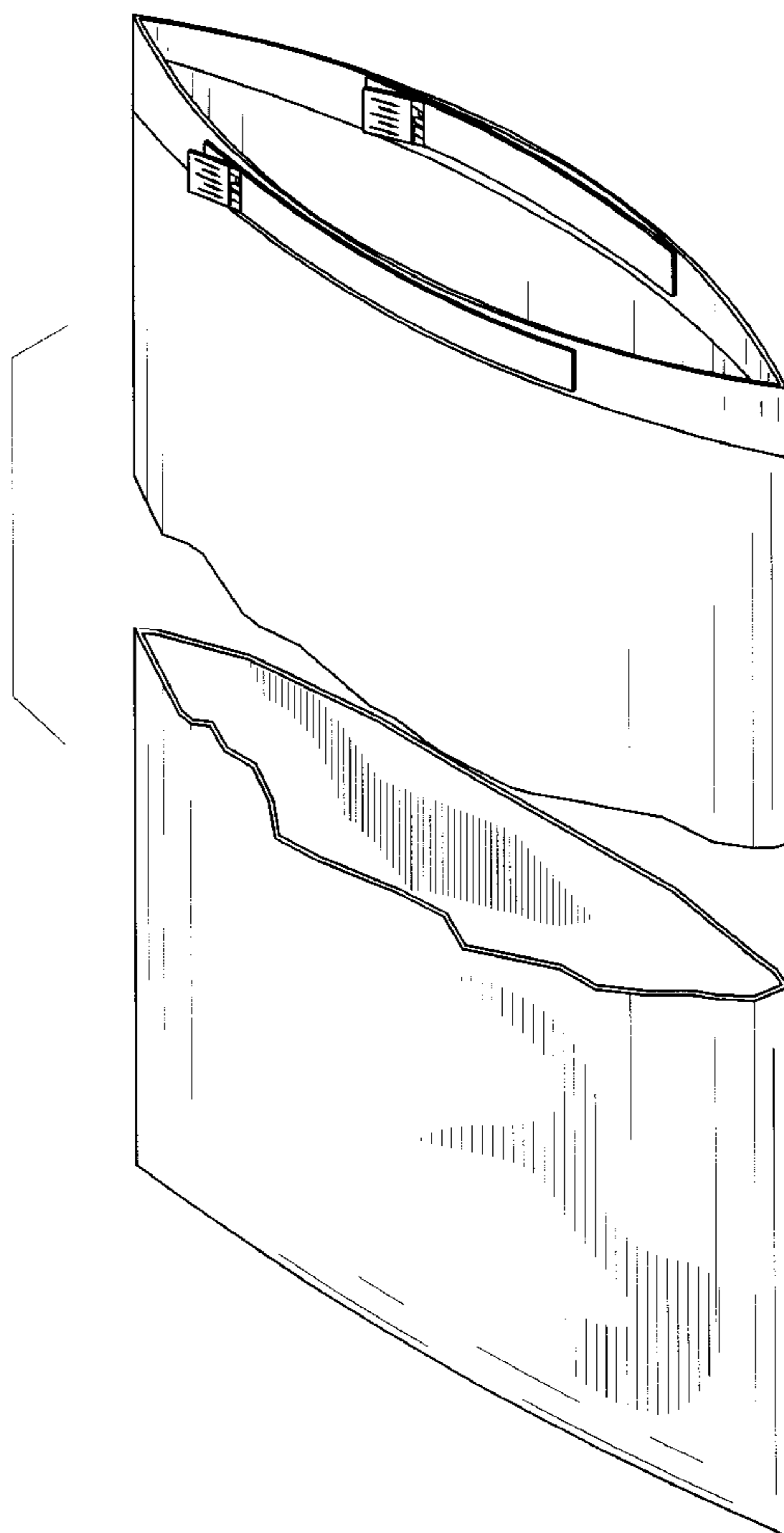
[57] **CLAIM**

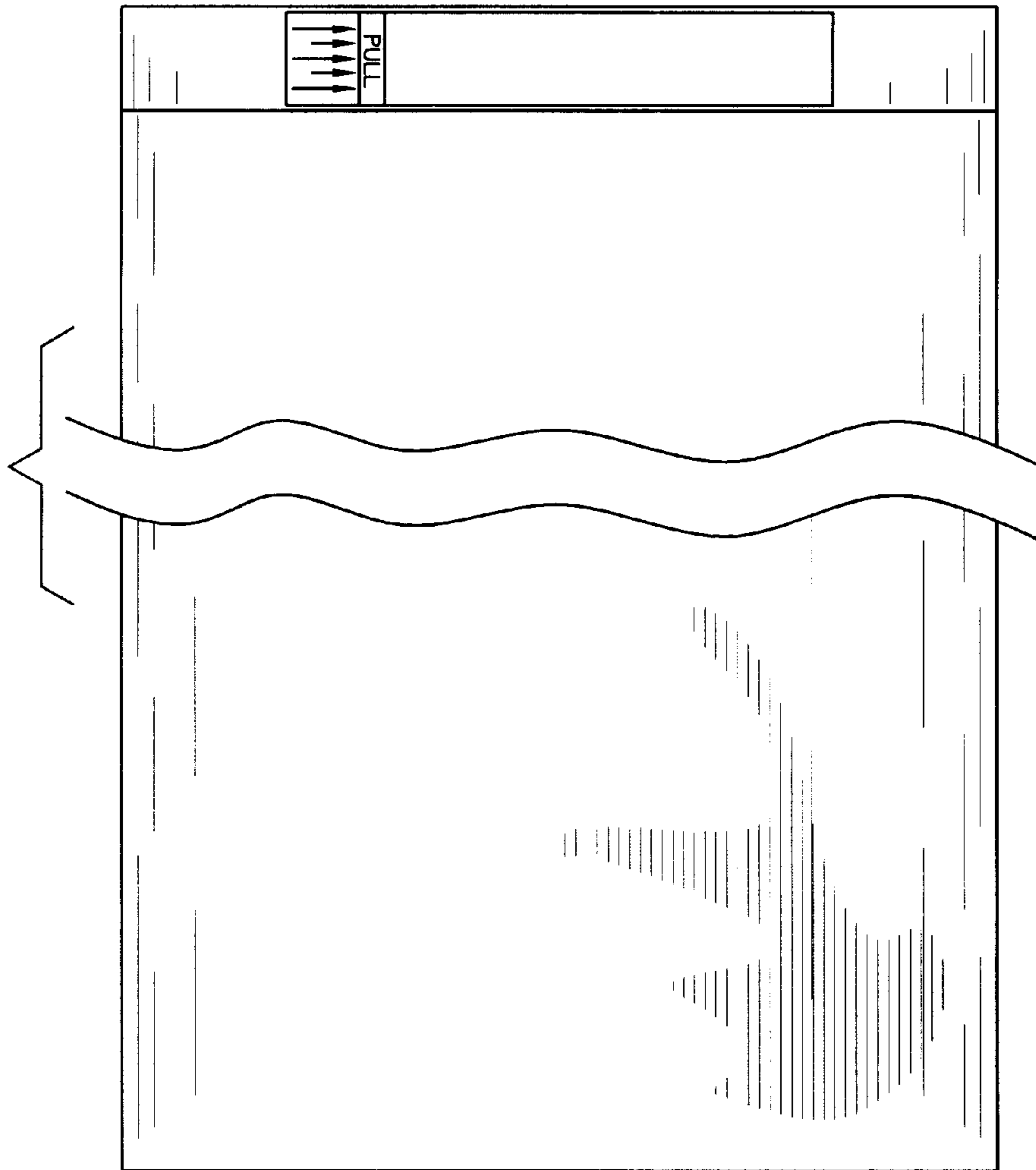
The ornamental design for a trash bag with adhesive retaining means, as shown and described.

**DESCRIPTION**

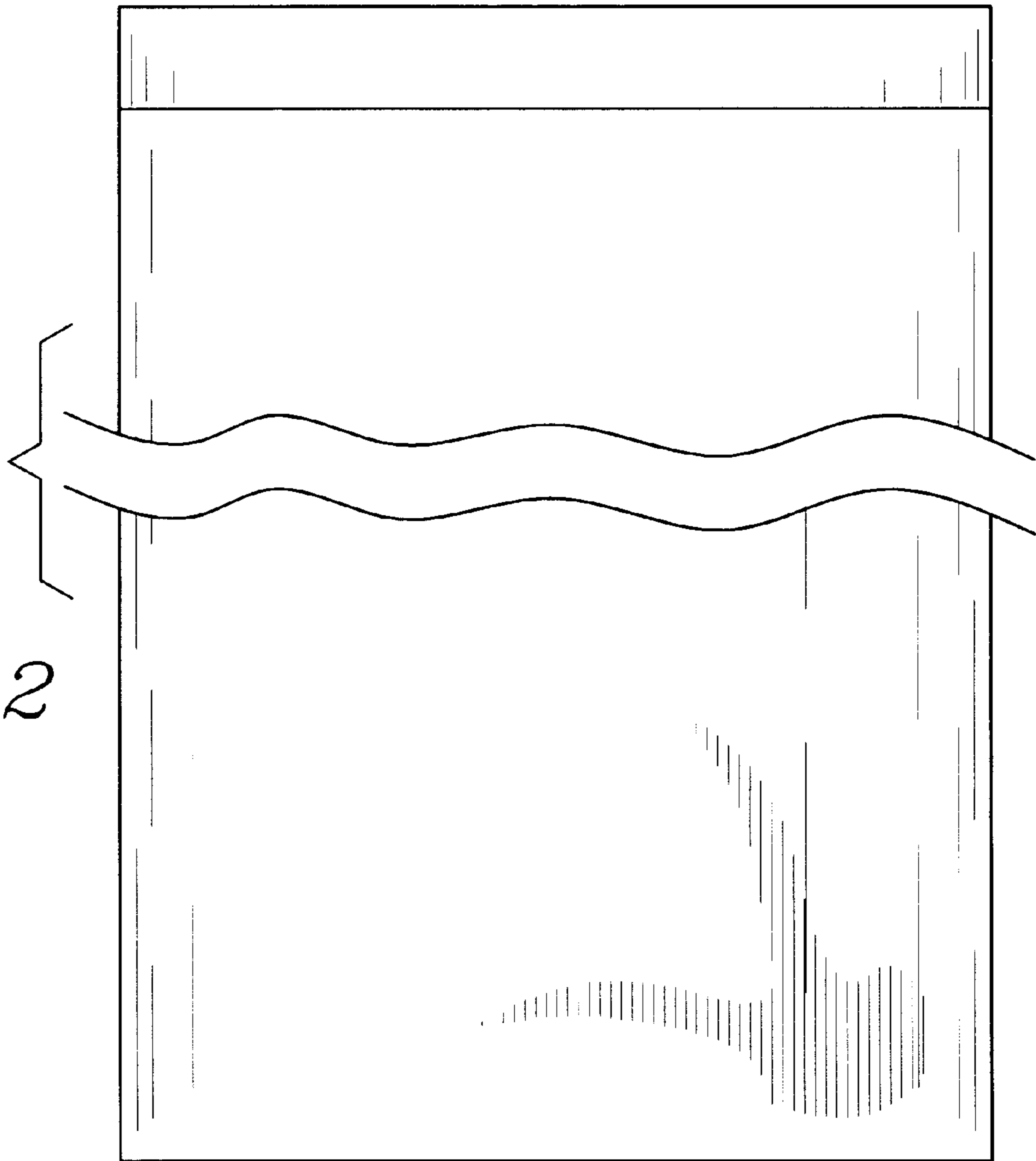
FIG. 1 is a front elevational view of the trash bag with adhesive retaining means of the present invention; FIG. 2 is a back elevational view of the trash bag with adhesive retaining means of FIG. 1; FIG. 3 is a left side elevational view of the trash bag with adhesive retaining means of FIG. 1; FIG. 4 is a right side elevational view of the trash bag with adhesive retaining means of FIG. 1; FIG. 5 is a top plan view of the trash bag with adhesive retaining means of FIG. 1; FIG. 6 is a bottom plan view of the trash bag with adhesive retaining means of FIG. 1; and, FIG. 7 is a front, top, right side perspective view of the trash bag with adhesive retaining means of FIG. 1. The trash bag with adhesive retaining means is shown broken away in FIGS. 1, 2, 3, 4 and 7 to indicate indeterminate length.

**1 Claim, 4 Drawing Sheets**

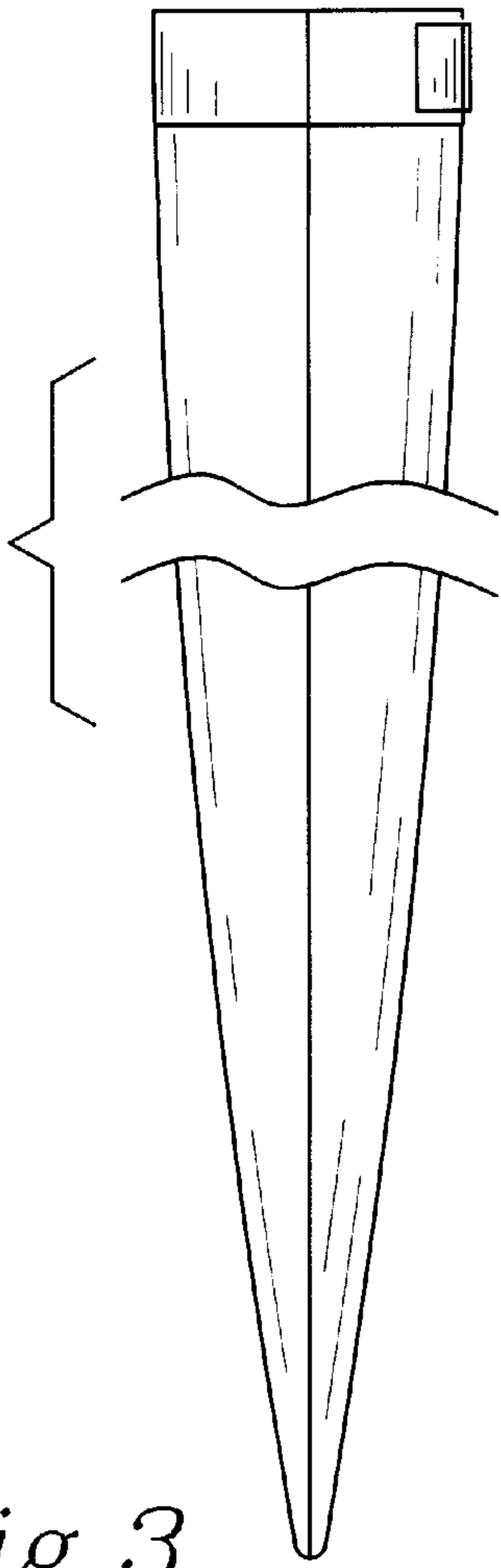




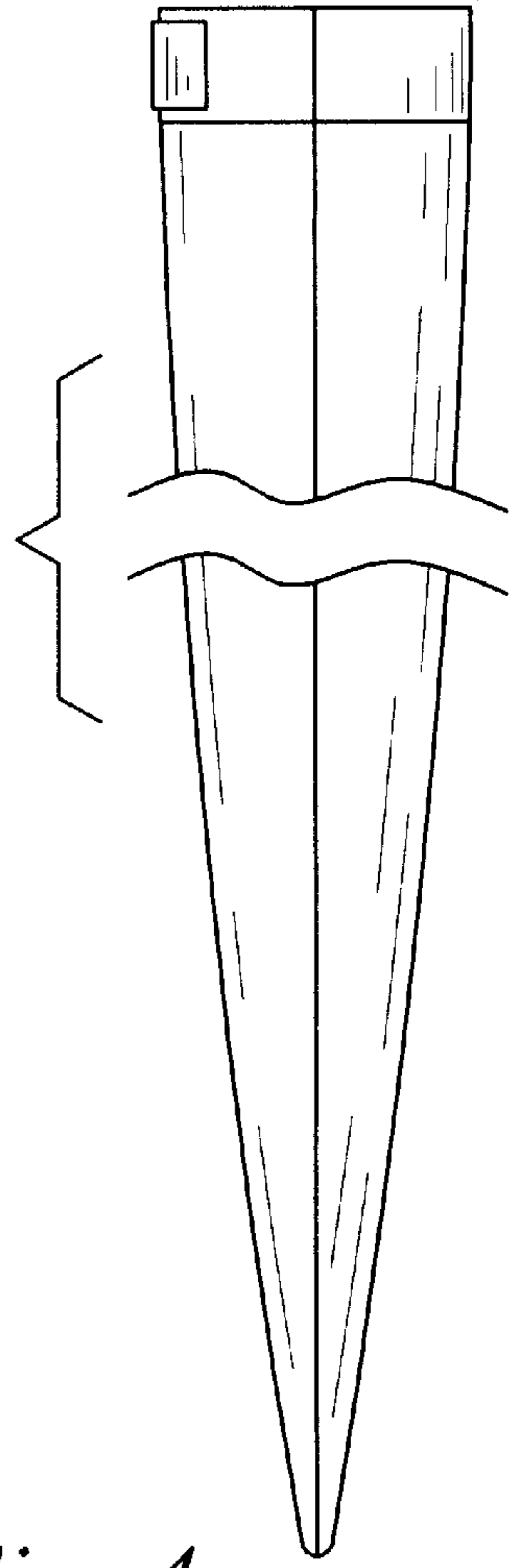
*Fig. 1*



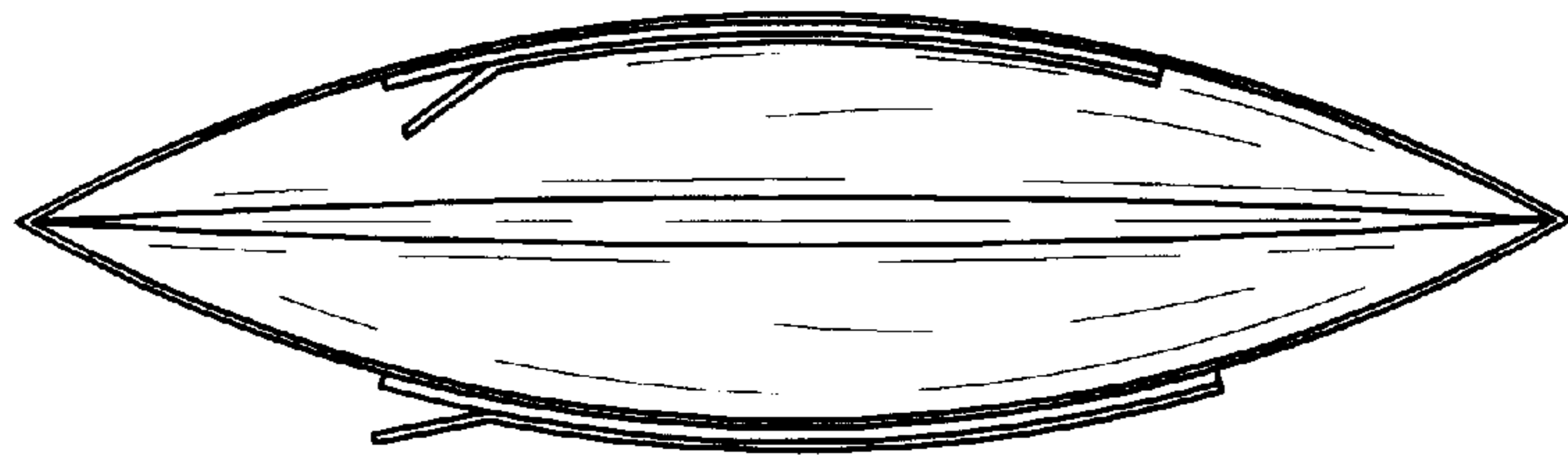
*Fig. 2*



*Fig. 3*



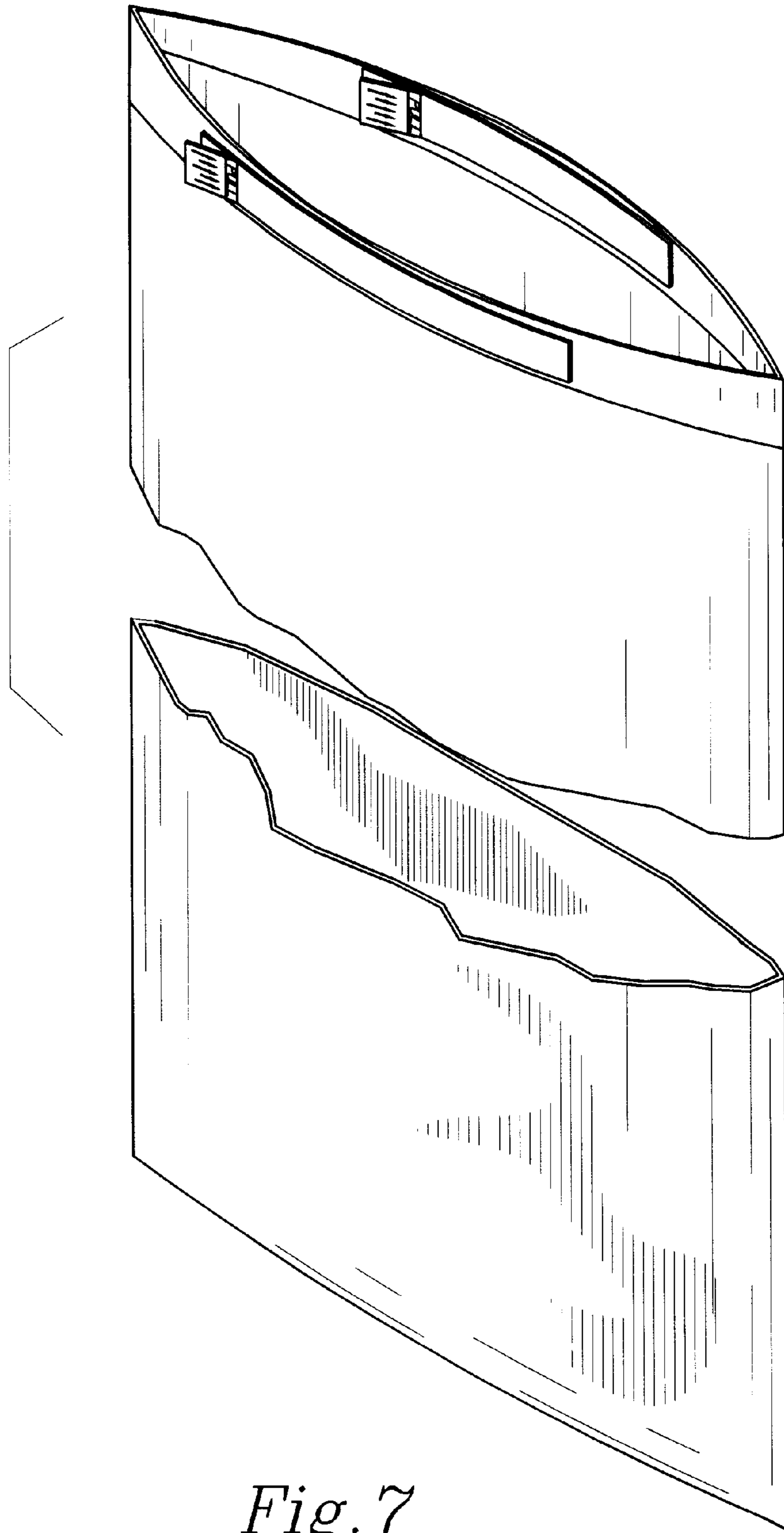
*Fig. 4*



*Fig. 5*



*Fig. 6*



*Fig. 7*