



US00D420891S

# United States Patent [19] Trangsrud

[11] Patent Number: Des. 420,891

[45] Date of Patent: \*\* Feb. 22, 2000

[54] STABILIZING GROUND ANCHOR

[75] Inventor: Julian P. Trangsrud, Northfield, Minn.

[73] Assignee: Royal Environmental Systems, Inc.,  
Stacy, Minn.

[\*\*] Term: 14 Years

[21] Appl. No.: 29/098,319

[22] Filed: Dec. 28, 1998

[51] LOC (7) Cl. .... 08-05

[52] U.S. Cl. .... D8/354

[58] Field of Search ..... D8/354, 1; D6/417;  
47/42; 405/244

- 4,003,169 1/1977 Young, II .
- 4,574,539 3/1986 Deike .
- 4,688,360 8/1987 Luong et al. .
- 4,738,063 4/1988 Alsop .
- 4,802,317 2/1989 Chandler .
- 5,123,779 6/1992 Miller .
- 5,175,966 1/1993 Remke et al. .
- 5,322,386 6/1994 Trangsrud .
- 5,720,579 2/1998 Trangsrud .
- 5,775,037 7/1998 James .

Primary Examiner—Holly Baynham  
Attorney, Agent, or Firm—Nikolai, Mersereau & Dietz, P.A.

### [57] CLAIM

The ornamental design for the “stabilizing ground anchor,” as shown and described.

### DESCRIPTION

FIG. 1 is a perspective view of a stabilizing ground anchor showing my new design;  
FIG. 2 is a right side elevational view thereof;  
FIG. 3 is a left side elevational view thereof;  
FIG. 4 is a front elevational view thereof;  
FIG. 5 is a back elevational view thereof;  
FIG. 6 is a top plan view thereof; and,  
FIG. 7 is a bottom plan view thereof.

1 Claim, 2 Drawing Sheets

### [56] References Cited

#### U.S. PATENT DOCUMENTS

- 936,824 10/1909 Simpson et al. .
- 972,306 10/1910 Wilcox .
- 1,002,350 9/1911 Wolcox .
- 1,047,097 12/1912 MacNab ..... 47/42 X
- 2,712,864 7/1955 Clevett, Jr. .
- 2,841,256 7/1958 Clevett, Jr. .
- 3,080,024 3/1963 Clevett, Jr. .
- 3,888,057 6/1975 Zubke .
- 3,969,854 7/1976 Deike .

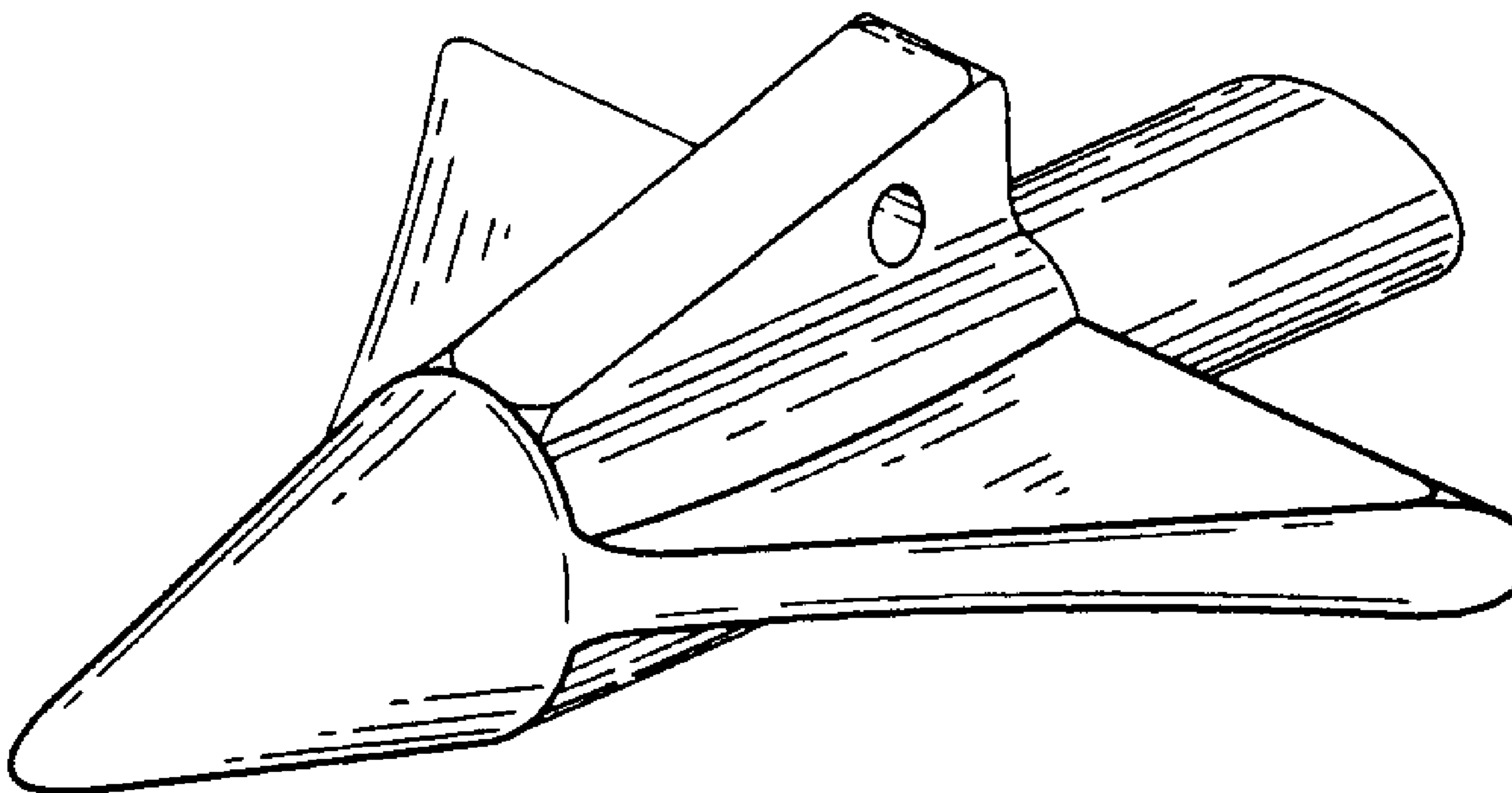

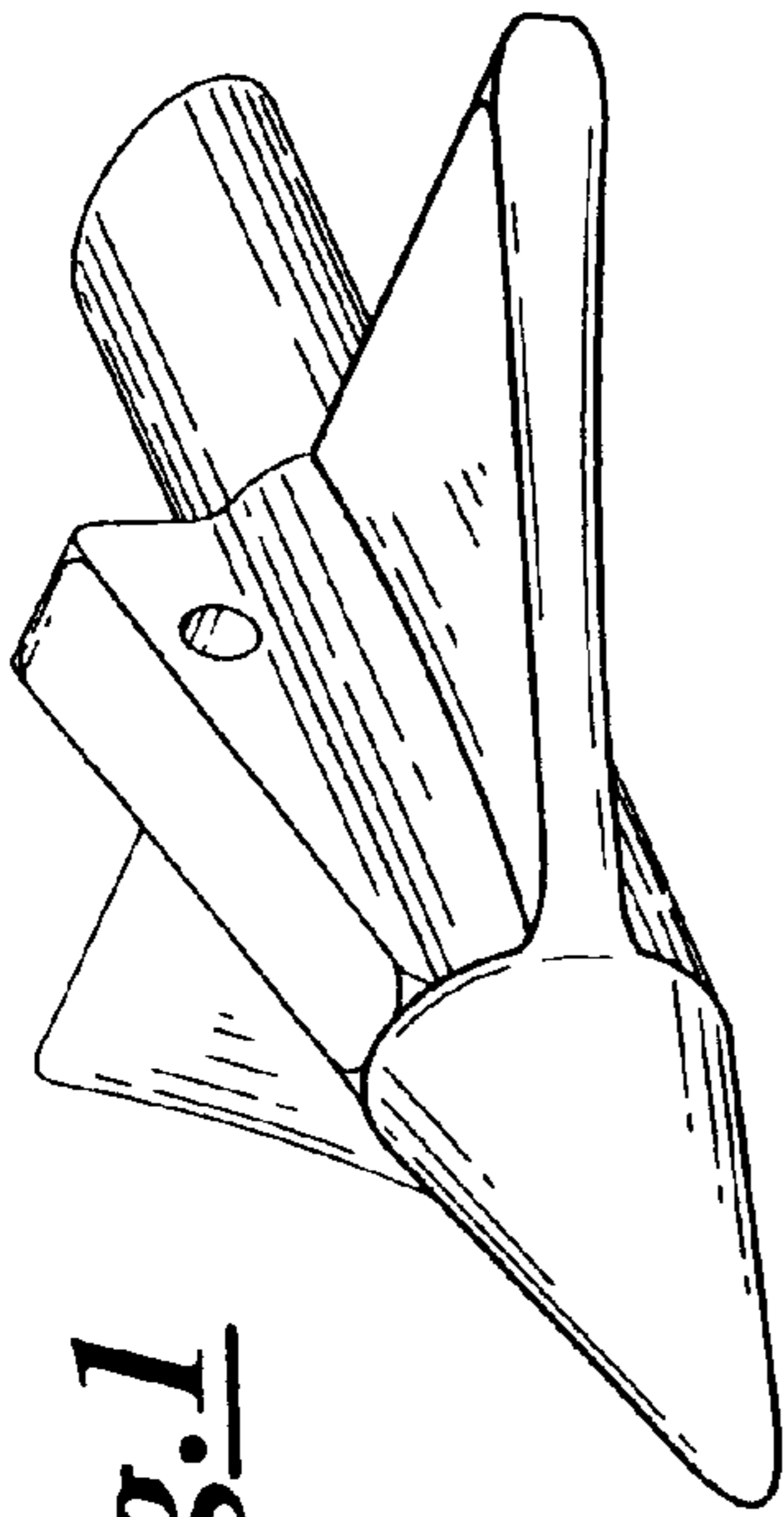

Fig. 1

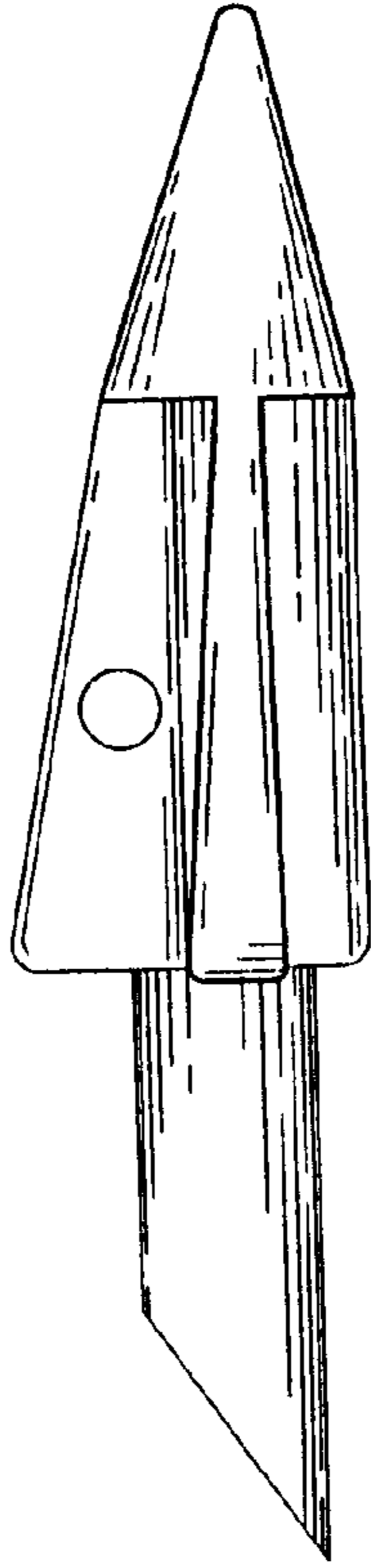

Fig. 2

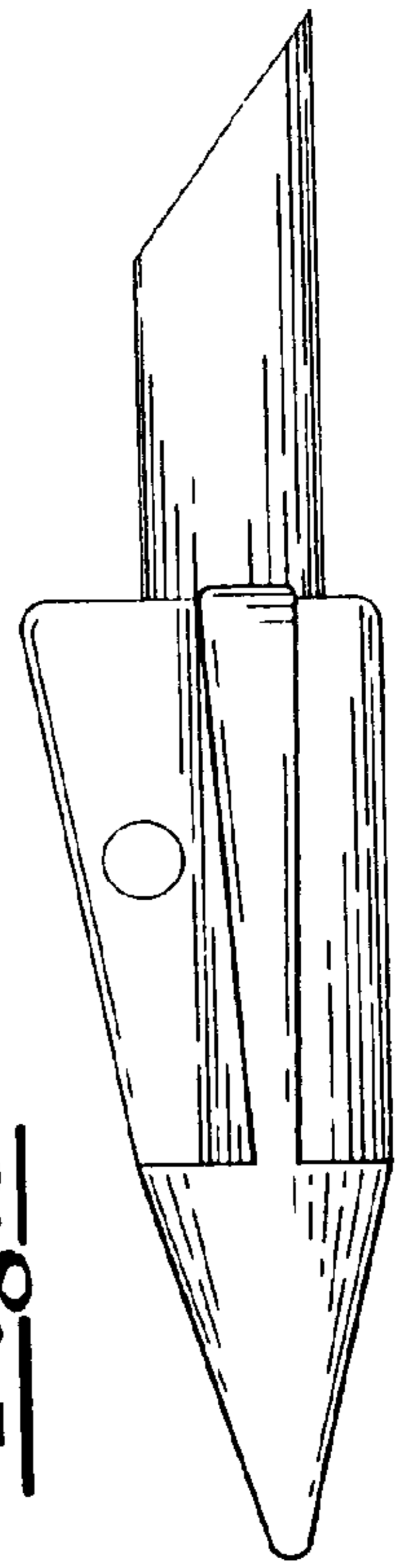

Fig. 3

Fig. 5

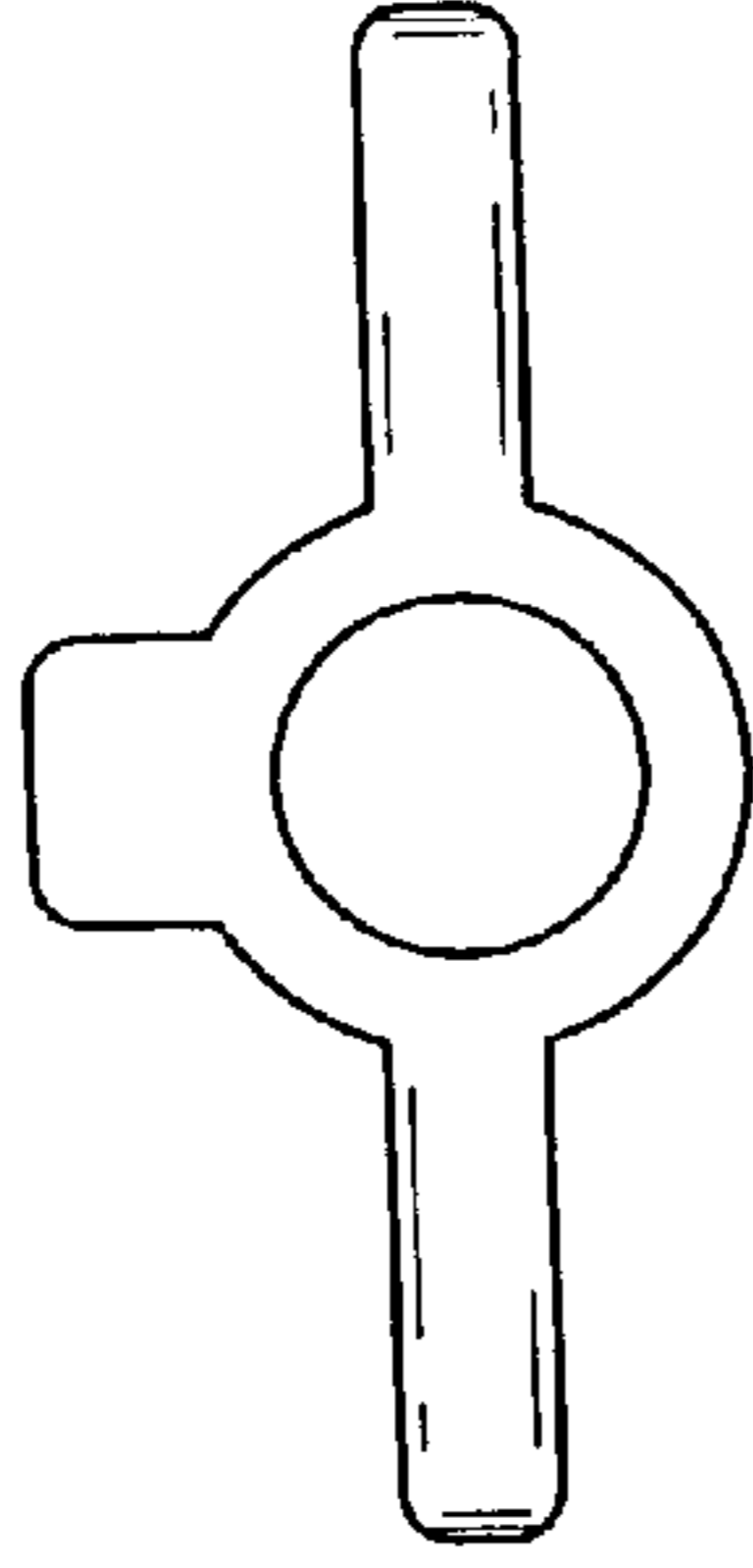

Fig. 4

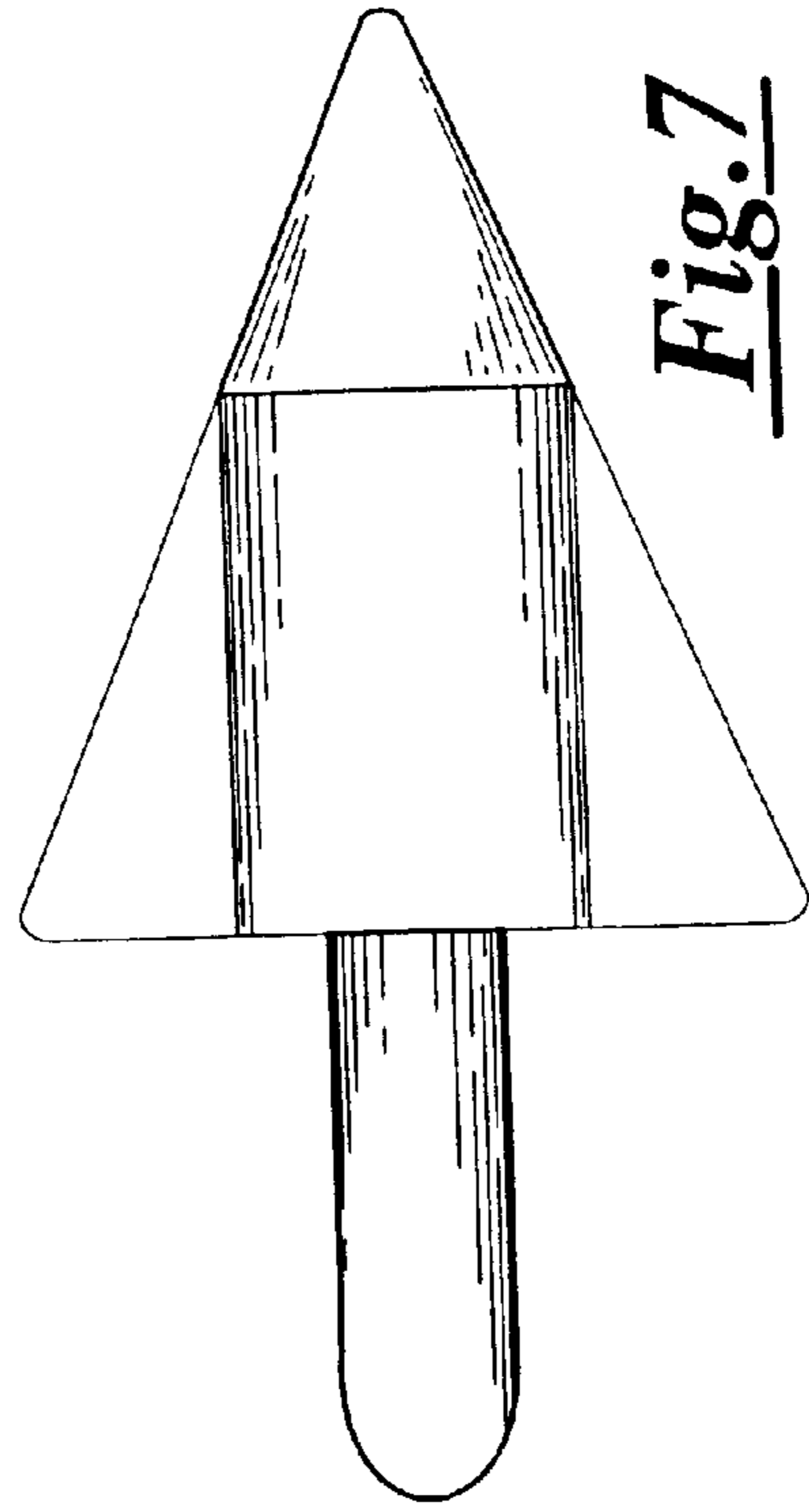
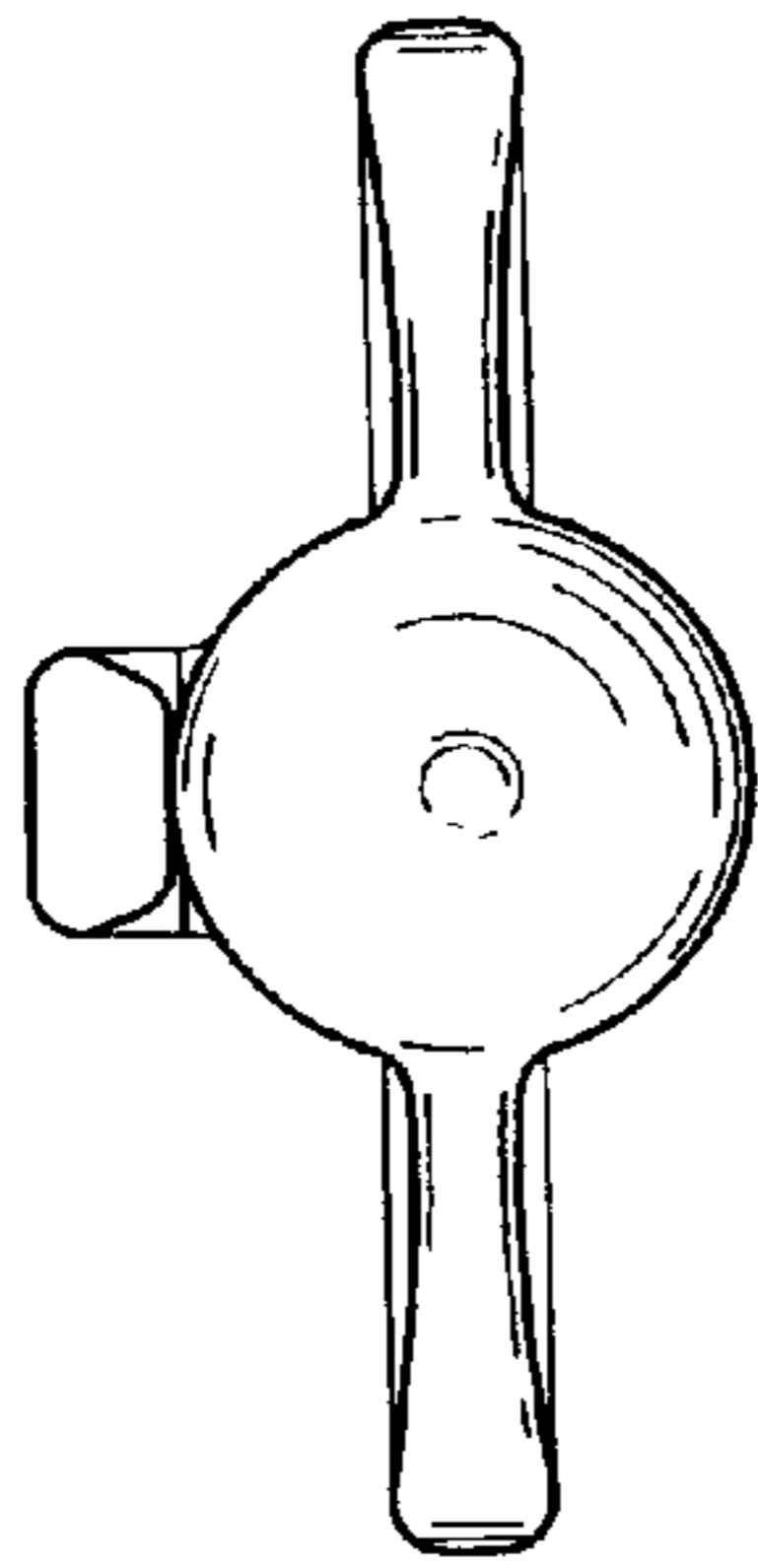

Fig. 7

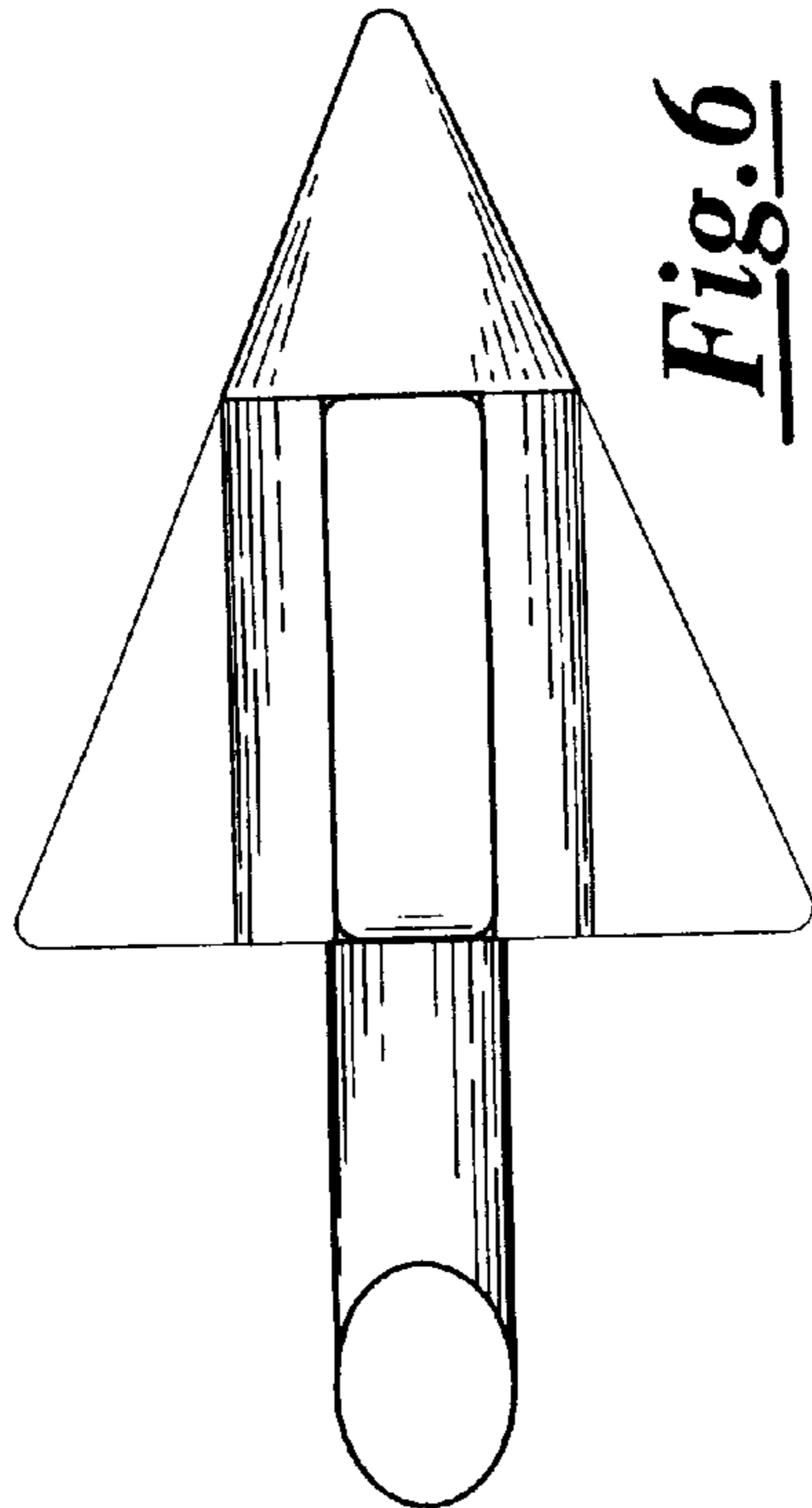

Fig. 6